

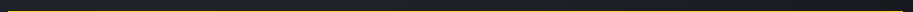

KINEX Measuring



KINEX 2020







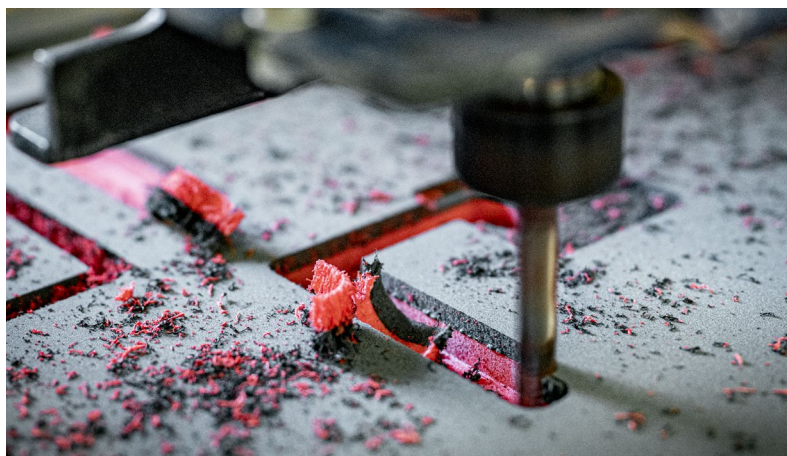
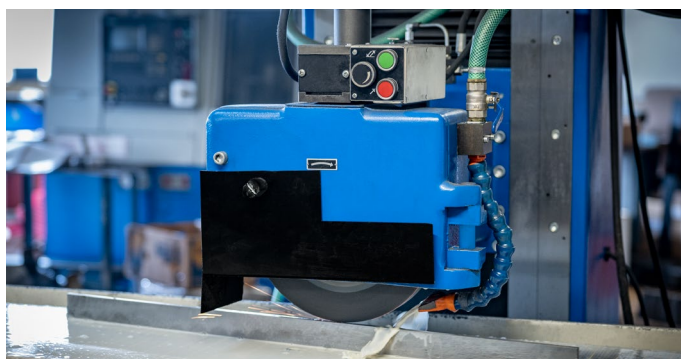













VÝROBA MĚŘICÍCH NÁSTROJŮ MANUFACTURE OF MEASURING TOOLS PRODUKCJA PRZYRZĄDÓW POMIAROWYCH

TRADICE OD ROKU 1893
TRADITION SINCE 1893
TRADYCJA OD 1893





Piktogramy | Pictograms | Piktogramy

 IP 67	Stupeň krytí Ingress Protection Marking Stopień ochrony		Rozměry šířka x výška x hloubka Dimensions Width x Height x Depth Wymiary szerokość x wysokość x głębokość
 ČSN 25 5170	Vyrobena dle české technické normy Manufactured according to Czech standards Wyprodukowane zgodnie z czeskimi normami technicznymi		Rozsah měření Measuring range Zakres pomiarowy
 DIN 863	Vyrobena dle německé národní normy Manufactured according to German national standards Wyprodukowane zgodnie z niemieckimi normami technicznymi		Rozlišení Resolution Rozdzielczość
 PN 25 1125	Vyrobena dle podnikové normy KINEX Manufactured according to company standards KINEX Wyprodukowane zgodnie ze standardami firmy KINEX		Průřez Cross-section Przekrój
 INOX	Vyrobena z nerezové oceli Made of stainless steel Wyprodukowane ze stali nierdzewnej		Nestandardní přeprava Non-standard transportation Niestandardowy transport
 Al	Vyrobena ze slitiny hliníku Made of aluminum alloy Wyprodukowane ze stopu aluminium		Magnetické upínání Magnetic Uchwyt magnetyczny
 0 class	Třída přesnosti Class of accuracy Klasa dokładności		Nová řada měřidel News Nowy typ urządzeń pomiarowych
 0,01	Rozlišení 0,01 Resolution 0,01 Rozdzielczość 0,01		Novinka News Aktualności
 0,001	Rozlišení 0,001 Resolution 0,001 Rozdzielczość 0,001		Bezdrátový přenos dat - Bluetooth Wireless data transfer - Bluetooth Bezprzewodowy transfer danych - Bluetooth
 2mm	Rychloposuv 2mm / ot. Quick displacement 2 mm / rev Szybko odkręcana 2 mm / obr.		

e-shop: <https://shop.kinexmeasuring.com>

Aktuální katalog a ceník včetně kalibrací najdete na www.kinexmeasuring.com

Fotografie výrobků nemusí vždy odpovídat provedení výrobku z důvodu technické obměny sortimentu.

Tiskové chyby vyhrazeny.

The current catalog and price list including calibration can be found at www.kinexmeasuring.com

Product photos may be different from the real products due to technical upgrading of range.

Printing errors stipulated.

Aktualny katalog oraz ceny dostępne są na : www.kinexmeasuring.com

Z powodu różnych wykonań poszczególnych narzędzi, ich wygląd nie zawsze odpowiada zdjęciom na naszych stronach i w sklepie internetowym.

Przepraszamy za błędy wynikłe w druku.

Obsah | Contents | Zawartość

Měřítka Rulers Przymiary	2 - 5	Rýsovací jehly a tužky Scribers Rysik i ołówek	26
Pravítka Straight edges Liniały	6 - 7	Vratidla Tap Wrenches Pokrętła	27
Příměrné desky a stoly Surface Plates, Tables Płyty traserskie i stoły	8 - 9	Nástavce závitníků Tap Extensions Przedłużacze do gwintowników	27
Rýsovací podložky V - blocks Przmy pomiarowe	10	Úhelníky Squares Kątowniki	28 - 36
Měrky Slip & Pin Gauge Sets Szczelinomierze	11 14 - 16	Vodováhy Spirit Levels Poziomice	37 - 40
Lupy Magnifying Glasses Lupy	12	Posuvná měřítka Calipers Suwmiarki	41 - 53
Tvrdoměry Hardness Twardościomierze	12	Lesnické průměrky Forester Calipers Suwmiarki leśnicze	53
Úhloměry Protractors Kątomierze	13	Mikrometry Micrometers Mikrometry	54 - 66
Šablony Templates Szablony	15	Svinovací metry Measuring Tapes Miary zwijane	66 - 69
Stojánky Stands Podstawki	17 - 18	Pásma Long Tapes Miary zwijane	70 - 71
Úchylkoměry Indicators Czujniki	19 - 21	Sady Gauge Sets Zestawy	72
Hmatadla Internal & External Calipers Macki	22	Kalibry Gauges Sprawdziany	73 - 77
Hloubkoměry Depth Gauges Głębokościomierze	23	Doplňkový sortiment Additional assortment Dodatkowy asortyment	78 - 80
Kružidla Spring Bow Dividers Cyrkle	24	Lasery Lasers Lasery	81 - 82
Výškoměry Height Gauges Wysokościomierze	25	Bezdrátové měření Wireless Data Transfer Pomiar bezprzewodowy	83 - 85

KINEX Measuring s.r.o.

Podnikatelská 586
190 11 Praha 9
Czech Republic

tel.: +420 775 418 428
objednavky@kinexmeasuring.com

KINEX Measuring a.s.

1. mája 1200
014 01 Bytča
Slovakia

tel.: +421 948 376 476
odbyt@kinexmeasuring.com

KINEX Measuring s.r.o.

Podnikatelská 586
190 11 Praha 9
Czech Republic

tel.: +420 778 014 145
export@kinexmeasuring.com

KINEX Measuring s.r.o.

Podnikatelská 586
190 11 Praha 9
Czech Republic

tel.: +48 784 764 696
kinexpolska@kinexmeasuring.com





Měřítka | Rulers | Przymiary

Měřítka ocelové, ploché s přesahem, popis laserem
 Steel Ruler with mm graduation, laser marking
 Przymiar kreskowy sztywny, znakowanie laserowe

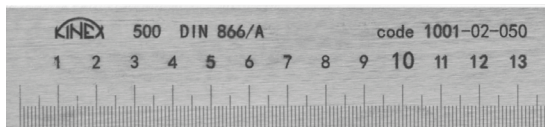

DALŠÍ ROZMĚRY NA ZAKÁZKU
 OTHER SIZES ON REQUEST
 INNE WYMIARY NA ZAMÓWIENIE

BEZ POVRCHOVÉ ÚPRAVY | WITHOUT FINISH | NIEPOWLEKANE

CODE	L [mm]	l [mm]	s [mm]	t [mm]
1001-02-030	310	300	25	5
1001-02-050	510	500	30	6
1001-02-100	1010	1000	40	8
1001-02-150	1510	1500	40	8
1001-02-200	2010	2000	50	10
1001-02-300	3010	3000	50	10
1001-02-400	4010	4000	60	12



NEREZOVÁ OCEL | STAINLESS STEEL | STAL NIERDZEWNA

INOX	CODE	L [mm]	l [mm]	s [mm]	t [mm]
	1001-07-030	310	300	25	5
	1001-07-050	510	500	30	6
	1001-07-100	1010	1000	40	8
	1001-07-150	1510	1500	40	8
	1001-07-200	2010	2000	50	10
	1001-07-300	3010	3000	50	10
	1001-07-400	4010	4000	60	12

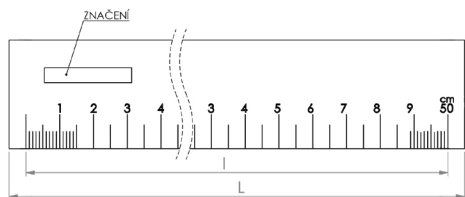

Měřítka ocelové, ploché s úkošem, popis laserem
 Stahllineal mit facette, mit mm-teilung, laserbeschriftungin
 Przymiar kreskowy sztywny ze skosem, opis laserowy

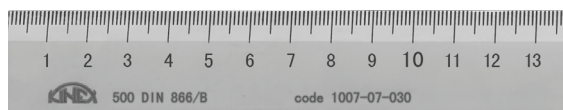

BEZ POVRCHOVÉ ÚPRAVY | WITHOUT FINISH | NIEPOWLEKANE

CODE	L [mm]	l [mm]	s [mm]	t [mm]
1007-02-030	310	300	25	5
1007-02-050	510	500	25	5
1007-02-100	1010	1000	30	6
1007-02-150	1510	1500	30	6
1007-02-200	2010	2000	40	8
1007-02-300	3010	3000	50	8



NEREZOVÁ OCEL | STAINLESS STEEL | STAL NIERDZEWNA

INOX	CODE	L [mm]	l [mm]	s [mm]	t [mm]
	1007-07-030	310	300	25	5
	1007-07-050	510	500	25	5
	1007-07-100	1010	1000	30	6
	1007-07-150	1510	1500	30	6
	1007-07-200	2010	2000	40	8
	1007-07-300	3010	3000	50	8

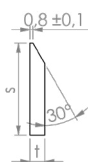
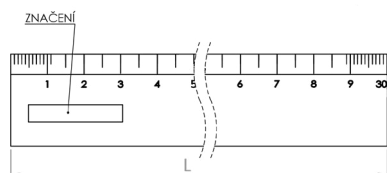

Měřítka | Rulers | Przymiary

Měřítko ocelové ploché, začátek v nule, popis laserem
Steel Ruler with mm graduation, laser marking
Przymiar kreskowy sztywny, opis laserowy

DIN
866/B



DALŠÍ ROZMĚRY NA ZAKÁZKU
OTHER SIZES ON REQUEST
INNE WYMIARY NA ZAMÓWIENIE

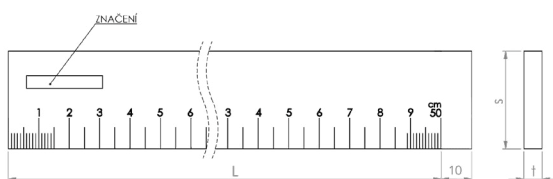

BEZ POVRCHOVÉ ÚPRAVY | WITHOUT FINISH | NIEPOWLEKANE

CODE	L [mm]	s [mm]	t [mm]
1012-02-030	300	25	5
1012-02-050	500	25	5
1012-02-100	1000	30	6
1012-02-150	1500	30	6
1012-02-200	2000	40	8
1012-02-250	2500	40	8
1012-02-300	3000	40	8
1012-02-400	4000	50	10
1012-02-500	5000	60	12

NEREZOVÁ OCEL | STAINLESS STEEL | STAL NIERDZEWNA

INOX

CODE	L [mm]	s [mm]	t [mm]
1012-07-030	300	25	5
1012-07-050	500	25	5
1012-07-100	1000	30	6
1012-07-150	1500	30	6
1012-07-200	2000	40	8

Nemagnetické | Non-magnetic | Niemagnetyczny ULTRA-LIGHT

AI

CODE	L [mm]	s [mm]	t [mm]
1012-04-030	300	32	5
1012-04-050	500	32	5
1012-04-100	1000	32	5



Měřítko ocelové ploché, začátek v nule, stupnice INCH, popis laserem
Steel Ruler with INCH graduation, laser marking
Przymiar kreskowy sztywny, skala INCH, opis laserowy

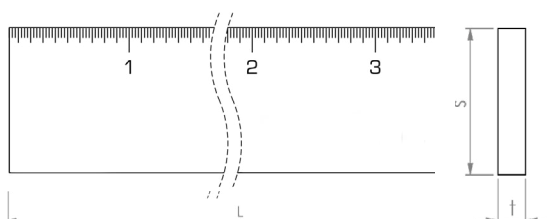

NEREZOVÁ OCEL | STAINLESS STEEL | STAL NIERDZEWNA

INOX

CODE	L	s [mm]	t [mm]
1012-07-024	24"	25	5
1012-07-040	40"	32	6

Měřítko s vertikální stupnicí, popis laserem
Steel Ruler with vertical mm scale, laser marking
Przymiar kreskowy sztywny z pionową skalą, opis laserowy

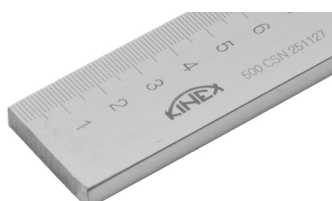

NEREZOVÁ OCEL | STAINLESS STEEL | STAL NIERDZEWNA

INOX

CODE	L [mm]	s [mm]	t [mm]
1027-07-050	500	25	5
1027-07-100	1000	32	6



Měřítka | Rulers | Przymiary

Měřítko ocelové tenké BLACK COAT, laser: popis (vhodné pro kalibraci)
 Steel Thin Ruler BLACK COAT, laser marking (suitable for calibration)
 Przymiar kreskowy półsztywny BLACK COAT, opis laser: (nadaje się do kalibracji)

1 EC-DIN 2004/22 I class

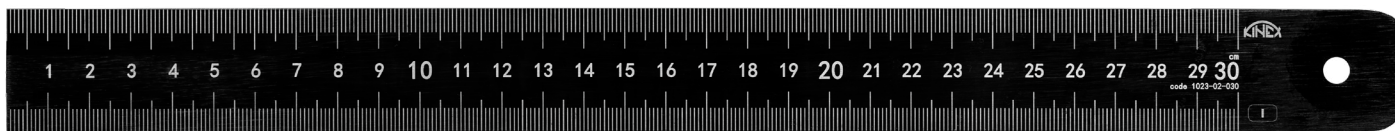

CODE	L [mm]	s [mm]	t [mm]
1023-02-030	300	30	1
1023-02-050	500	30	1
1023-02-100	1000	30	1

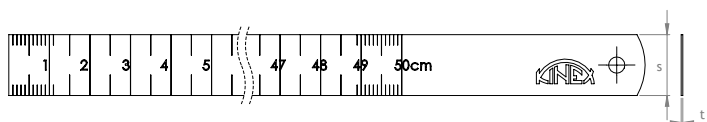

Měřítko ocelové tenké, laserový popis (vhodné pro kalibraci)
 Steel Thin Ruler, laser marking (suitable for calibration)
 Przymiar kreskowy półsztywny, opis laserowy (nadaje się do kalibracji)

1 EC-DIN 2004/22 I class



CODE	L [mm]	s [mm]	t [mm]
1023-05-030	300	30	1
1023-05-050	500	30	1
1023-05-100	1000	30	1
1023-05-150	1500	30	1
1023-05-200 	2000	30	1

Měřítko ocelové tenké, laserový popis (vhodné pro kalibraci)
 Steel Thin Ruler, laser marking (suitable for calibration)
 Przymiar kreskowy półsztywny, opis laserowy (nadaje się do kalibracji)

0,5 EC-DIN 2004/22 I class



CODE	L [mm]	s [mm]	t [mm]
1023-25-030	300	30	1
1023-25-050	500	30	1
1023-25-100	1000	30	1

Měřítka | Rulers | Przymiary

Měřítka ocelové tenké - barevné značení, převodní tabulka, laserový popis
Steel Thin Ruler - color marking, conversion table, laser marking
Przymiar kreskowy pólstywny, tabela przeliczeniowa, opis laserowy

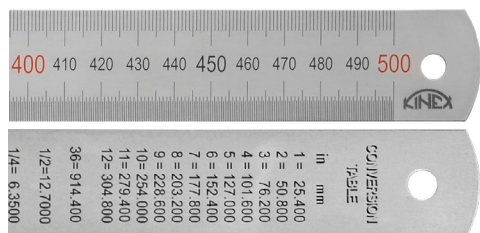

0,5

CODE	L [mm]	s [mm]	t [mm]
1022-02-030	300	25	1
1022-02-050	500	30	1
1022-02-100	1000	30	1

Měřítka ocelové tenké, laserový popis
Steel Thin Ruler, laser marking
Przymiar kreskowy elastyczny, opis laserowy

1

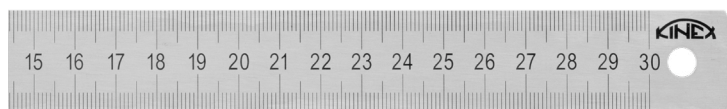

CODE	L [mm]	s [mm]	t [mm]
1022-0	150	13	0,5
1022-1	200	13	0,5
1022	300	25	1,0
1023	500	30	1,0
1024	1000	38	2,0
1025	1500	38	2,0
1026	2000	40	2,0

Měřítka ocelové ohebné BLACK COAT, laser. popis
Steel Thin Ruler KINEX BLACK COAT, laser marking
Przymiar kreskowy pólstywny BLACK COAT, opis laser.

1

I
class



CODE	L [mm]	s [mm]	t [mm]
1017-02-015	150	13	0,5
1017-02-030	300	13	0,5
1017-02-050	500	15	0,5
1017-02-100	1000	20	0,5
1017-02-150	1500	20	0,5
1017-02-200	2000	20	0,5



CODE	L [mm]	s [mm]	t [mm]
1017-05-015	150	13	0,5
1017-05-030	300	13	0,5
1017-05-050	500	15	0,5
1017-05-100	1000	20	0,5

Měřítka ocelové ohebné, laserový popis
Flexible Steel Ruler, laser marking (suitable for calibration)
Przymiar kreskowy pólstywny, opis laserowy

1



CODE	L [mm]	s [mm]	t [mm]
1017	300	13	0,5
1018	500	15	0,5
1019	1000	20	0,5
1020	1500	20	1,2
1021	2000	20	1,2



Pravítka | Straight Edges | Liniály

Pravítko kontrolní (k měření rovinnosti), popis laserem
Precision Straight Edge (for measuring flatness), laser marking
Liniál kontrolny do pomiaru płaskości, opis laserowy

DIN
874



BEZ POVRCHOVÉ ÚPRAVY | WITHOUT FINISH | NIEPOWLEKANE

0
class

CODE	L [mm]	s [mm]	t [mm]
1039-02-050	500	50	10
1039-02-075	750	50	10
1039-02-100	1000	60	12
1039-02-150	1500	70	15
1039-02-200	2000	80	15
1039-02-250	2500	100	16
1039-02-300	3000	120	20
1039-02-400	4000	140	20

I
class

CODE	L [mm]	s [mm]	t [mm]
1039-12-050	500	40	8
1039-12-075	750	50	10
1039-12-100	1000	50	10
1039-12-150	1500	60	12
1039-12-200	2000	70	15
1039-12-250	2500	80	15
1039-12-300	3000	100	16
1039-12-400	4000	120	20

II
class

CODE	L [mm]	s [mm]	t [mm]
1039-22-050	500	30	6
1039-22-075	750	40	8
1039-22-100	1000	40	8
1039-22-150	1500	50	10
1039-22-200	2000	60	12
1039-22-250	2500	70	15
1039-22-300	3000	80	15
1039-22-400	4000	100	16
1039-22-500	5000	120	20

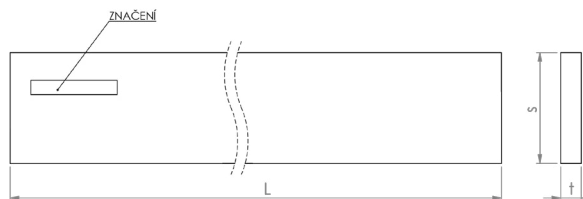

DALŠÍ ROZMĚRY NA ZAKÁZKU
OTHER SIZES ON REQUEST
INNE WYMIARY NA ZAMÓWIENIE

Pravítko kontrolní (k měření rovinnosti), popis laserem
Precision Straight Edge (for measuring flatness), laser marking
Liniál kontrolny do pomiaru płaskości, opis laserowy

DIN
874



NEREZ OCEĽ | NEREZ OCEĽ | STAL NIERDZEWNA

I
class

CODE	L [mm]	s [mm]	t [mm]
1039-17-050	500	40	8
1039-17-075	750	50	10
1039-17-100	1000	50	10
1039-17-150	1500	60	12
1039-17-200	2000	60	12
1039-17-250	2500	80	15
1039-17-300	3000	100	16
1039-17-400	4000	120	18

INOX

I
class

ALUMINIUM

CODE	L [mm]	s [mm]	t [mm]
1039-14-050	500	60	12
1039-14-100	1000	60	12
1039-14-150	1500	100	16
1039-14-200	2000	100	16

Al

DALŠÍ TŘÍDY PŘESNOSTI NA ZAKÁZKU
OTHER ACCURACY CLASSES ON REQUEST
INNE KLASY DOKŁADNOŚCI NA ZAMÓWIENIE

Pravítka | Straight Edges | Liniały

Pravítko kontrolní odlehčené (k měření rovinnosti)
Precision Straight Edge (for measuring flatness)
Lekki liniał do kontroli płaskości

II
class

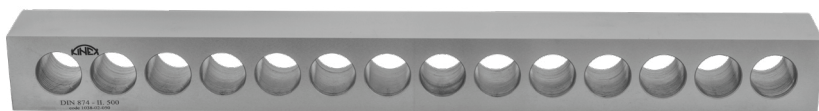

CODE	↔
1038-02-050	50x50x500 mm
1038-02-100	50x50x1000 mm
1038-02-150	50x50x1500 mm

DALŠÍ ROZMĚRY NA ZAKÁZKU | OTHER SIZES ON REQUEST | INNE WYMIARY NA ZAMÓWIENIE

Pravítko mostové kontrolní - litinové
Bridge Type Straight Edge
Liniał powierzchniowy żebrowany - żeliwo

DIN
876



I
class

CODE	↔
1033-12-050	500x40 mm
1033-12-075	750x45 mm

II
class

CODE	↔
1033-22-100	1000x50 mm
1033-22-150	1500x60 mm
1033-22-200	2000x70 mm

Pravítko nožové kalené
Knife Edge Straight Edge
Liniał krawędziowy hartowany

DIN
874-2

00
class

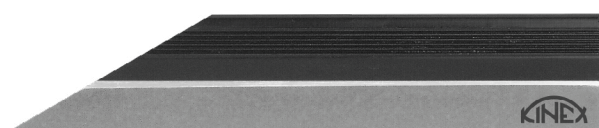

00
class

NEW
LINE

CODE	↔
1061-05-075	75x25x5 mm
1061-05-100	100x25x5 mm
1061-05-125	125x25x5 mm
1061-05-150	150x25x5 mm
1061-05-200	200x29x7 mm
1061-05-300	300x29x7 mm
1061-05-400	400x33x10 mm
1061-05-500	500x33x10 mm

00
class

NEREZOVÁ OCEL | STAINLESS STEEL | STAL NIERDZEWNA

CODE	↔
1061-07-075	75x25x5 mm
1061-07-100	100x25x5 mm
1061-07-125	125x25x5 mm
1061-07-150	150x25x5 mm
1061-07-200	200x29x7 mm
1061-07-300	300x29x7 mm
1061-07-400	400x33x10 mm
1061-07-500	500x33x10 mm
1061-07-600	600x45x10 mm
1061-07-750	750x60x12 mm
1061-07-1000	1000x60x12 mm

- » kalené na 55HRC a broušené
- » funkční plochy lapované
- » ochranná izolace proti přechodu tepla

- » 55HRC hardened and grinded
- » functional surfaces lapped
- » thermal insulation

- » 55HRC hartowane i szlifowane
- » funkcjonalne powierzchnie docierane
- » izolacja termiczna



Příměrné desky a stoly | Surface Plates, Tables | Płyty traserskie i stoly

Příměrná deska granitová, jemně lapovaná diamantem
Granite Surface Plate, gently lapped with diamond
Płyty pomiarowe granitowe

DIN
876/0



DALŠÍ ROZMĚRY NA ZAKÁZKU
OTHER SIZES ON REQUEST
INNE WYMIARY NA ZAMÓWIENIE

CODE	↔
1041-02-030	300x300x70 mm
1041-02-040	400x400x100 mm
1041-02-063	630x400x100 mm
1041-02-100	1000x630x150 mm
1041-02-120	1200x800x150 mm
1041-02-160	1600x1000x200 mm
1041-02-210	2000x1000x250 mm
1041-02-216	2000x1600x300 mm

Příměrná deska litinová
Cast Iron Surface Plate
Płyty traserskie żeliwne

DIN
876/1



Pro dosažení uvedené přesnosti je třeba ustavit desku na stole KINEX.

To achieve its accuracy it is necessary to set the plate on the KINEX table.

Aby osiągnąć podaną dokładność konieczne jest ustawienie płyty na stole KINEX.

DALŠÍ ROZMĚRY NA ZAKÁZKU
OTHER SIZES ON REQUEST
INNE WYMIARY NA ZAMÓWIENIE

CODE	↔
1042-02-030	300x300x65mm
1042-02-040	400x400x65mm
1042-02-060	600x450x75mm
1042-02-080	800x600x85mm
1042-02-100	1000x800x105mm
1042-02-120	1200x800x160mm

Stůl pod granitovou desku PROFI - svařované z jeklu, lakované
Table for Granite Surface Plate - welded hollow, lacquered
Stoly PROFI do płyt granitowych, spawane, malowane

Podstavec litinové desky PROFI - svařované z jeklu, lakované
Table for Cast Iron Surface Plate - welded hollow, varnished
Stoly PROFI do płyt żeliwnych, spawane, malowane



CODE	↔	pro pre dla
1041-12-040	224x224x700 mm	1041-02-040
1041-12-063	355x224x700 mm	1041-02-063
1041-12-100	560x355x700 mm	1041-02-100
1041-12-120	675x450x700 mm	1041-02-120
1041-12-160	900x560x700 mm	1041-02-160

CODE	↔	pro pre dla
1042-12-030	300x300x600 mm	1042-02-030
1042-12-040	400x400x600 mm	1042-02-040
1042-12-060	600x450x600 mm	1042-02-060
1042-12-080	800x600x600 mm	1042-02-080
1042-12-100	1000x800x600 mm	1042-02-100

Příměrné desky a stoly | Surface Plates, Tables | Płyty traserskie i stoly

Granitový kontrolní úhelník 90°
Precision Granite Square 90°
Kątownik kontrolny granitowy 90°



GRANITOVÉ KOSTKY A ÚHELNÍKY
BROUSÍME A DODÁVÁME NA ZAKÁZKU

GRANITE CUBES AND SQUARES
GRIND AND DELIVER TO ORDER

GRANITOWE KOSTKI, TRÓJKĄTY
I KWADRATY SZLIFUJEMY I
DOSTARCZAMY W RÓŻNYCH
ROZMIARACH
NA ŻYCZENIE KLIENTA

00
class

CODE		↔
1041-80		100x63x16 mm
1041-82		160x100x20 mm
1041-84		250x160x25 mm
1041-86		400x250x40 mm
1041-88		630x400x80 mm
1041-90		1000x630x80 mm

Na vyžádání nabízíme i verzi s garantovanou přesností všech měrných ploch od 0,2 μm.

Upon request, we also offer a version with a guaranteed accuracy of all measurement areas from 0,2 μm.

Na życzenie oferujemy również wersję z gwarantowaną dokładnością wszystkich powierzchni pomiarowych od 0,2 μm.



Rýsovací podložky | V - blocks | Pryzmy pomiarowe

Rýsovací podložky se zářezy - dodáváno v páru, kaleno na 60 HRC

V - BLOCKS (Pair), hardened to 60 HRC

Pryzmy pomiarowe z wycięciami - dostarczamy w parach, hartowane do 60 HRC



S JEDNÍM ZÁŘEZEM | 1 SLOT | Z JEDNYM WYCIĘCIEM

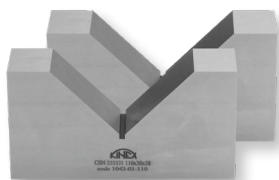

CODE	L	S	V	Z	α
1043-01-110	110	30	58	70	90°
1043-01-140	140	40	80	90	90°
1043-01-200	200	55	120	130	90°

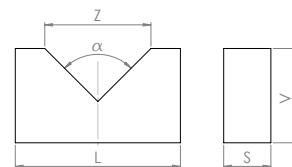

SE DVĚMA ZÁŘEZY | 2 SLOTS | Z DWOMA WYCIĘCIAMI

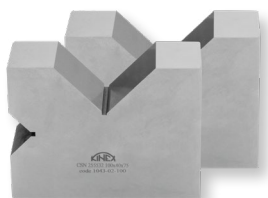

CODE	L	S	V	Z	Z1	α
1043-02-100	100	40	75	50	24	90°
1043-02-140	140	55	100	70	30	90°
1043-02-180	180	70	130	90	50	90°

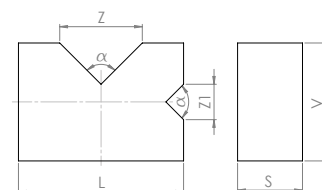

SE ČTYŘMI ZÁŘEZY | 4 SLOTS | Z CZTEREMA WYCIĘCIAMI



CODE	L	S	V	Z	Z1	Z2	Z3	α
1043-03-070	70	20	50	40	24	16	10	90°
1043-03-130	130	50	110	70	50	30	16	90°
1043-03-200	200	80	170	110	70	50	30	90°

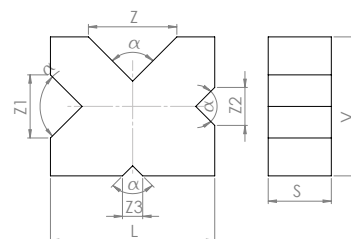

Na zakázku dodáváme i v provedení s magnetem.

We also supply version with magnets on request.

Dostarczamy również wykonane na zamówienie z magnesem.



Podpěrky

Support Props for general use

Podpórka



3034



1042-50



3035 - 3037

CODE	výška height wysokość	nosnost load cap. pojemność	sestava set zestaw
3034	63 mm		1 hlava 1 head 1 główka
3035	80 mm	14 000 N	sada hrotů tips set
3036	145 mm	45 000 N	zestaw wskaźówek
3037	205 mm	70 000 N	
1042-50	podpěrka ke stolům - náhradní díl Support Prop to the table - spare part Popórka do stołów - części zamienne		

Měrky | Slip & Pin Gauge Sets | Szczelinomierze

Základní ocelové měrky
Steel Slip Gauge Sets
Komplet płytek wzorcowych

**NEW
LINE**



I
class

CODE	ks pcs szt
1046-13-038	38
1046-13-047	47
1046-13-083	83
1046-13-087	87
1046-13-103	103
1046-13-112	112
1046-13-122	122

0
class

CODE	ks pcs szt
1046-03-038	38
1046-03-047	47
1046-03-083	83
1046-03-087	87
1046-03-103	103
1046-03-112	112
1046-03-122	122

Sestava měrek | Gage Set | Zestawy :
http://www.kinexmeasuring.com/SESTAVA_MERЕК.pdf

Základní keramické měrky
Square Ceramic Gage Block Set
Zestawy płytek wzorcowych ceramicznych

**NEW
LINE**

I
class



CODE	ks pcs szt
1050-13-032	32
1050-13-047	47
1050-13-087	87
1050-13-103	103

Válečkové měrky ocelové sada
Steel Pin Gage Set
Komplet wałeczków pomiarowych

**NEW
LINE**

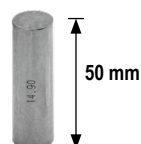

CODE		ks pcs szt	
1047-14-001	0,30 - 1,0/0,01 mm	71	2μm
1047-14-002	1,01 - 2,0/0,01 mm	100	2μm
1047-14-003	2,01 - 3,0/0,01 mm	100	2μm
1047-14-004	3,01 - 4,0/0,01 mm	100	2μm
1047-14-005	4,01 - 5,0/0,01 mm	100	2μm
1047-14-006	5,01 - 6,0/0,01 mm	100	2μm
1047-14-007	6,01 - 7,0/0,01 mm	100	2μm
1047-14-008	7,01 - 8,0/0,01 mm	100	2μm
1047-14-009	8,01 - 9,0/0,01 mm	100	2μm
1047-14-010	9,01 - 10,0/0,01 mm	100	2μm
1047-13-003	0,30 - 3,0/0,10 mm	28	2μm
1047-13-005	1,00 - 5,0/0,10 mm	41	2μm
1047-13-010	5,0 - 10,0/0,10 mm	51	2μm
1047-13-015	10,0 - 15,0/0,10 mm	51	2μm
1047-13-020	15,0 - 20,0/0,10 mm	51	2μm



Lupy | Magnifying Glasses | Lupy

Brinellova lupa se dvěma čočkami 16mm
Brinell Magnifying Glass 16 mm
Lupa Brinella 16mm



CODE			↔
1094-02-008	x8	0,1 mm	0 - 10 mm
1094-02-010	x10	0,1 mm	0 - 10 mm
1094-02-012	x12	0,1 mm	0 - 10 mm
1094-02-015	x15	0,1 mm	0 - 10 mm

CODE			↔
1094-03-008	x8	0,1 mm	0 - 15 mm
1094-03-010	x10	0,1 mm	0 - 15 mm
1094-03-012	x12	0,1 mm	0 - 15 mm
1094-03-015	x15	0,1 mm	0 - 15 mm

Hodinářská lupa se skleněnou čočkou 24 mm
Brinell Magnifying Glass 24 mm
Lupa zegarmistrzowska 24mm



CODE	
1094-1	x3
1094-2	x4
1094-3	x6

Lupa s mm stupnicí
Magnifier with mm scale
Lupa ze skalą mm



CODE	
1094-04-010	x10

Tvrdoměry | Hardness Gauges | Twardościomierze

Tvrdoměr Poldi - Tester
Hardness Gauge Poldi tester
Twardościomierz Poldi - Tester

INOX



tvrdost podle Brinella
Brinell hardness
twardość wg Brinella

CODE
1095-1

Úhlooměry | Protractors | Kątomierze

Úhloměr digitální 0 - 360°
Digital Universal Bevel Protractor with magn. glass & rules, 0 - 360°
Kątomierz elektroniczny 0 - 360°



CODE		
1093-20	0 - 360°	1' (0,01°)

Úhloměr s lupou a pravítky 0 - 360°
Universal Bevel Protractor with Magnifier and rulers 0 - 360°
Kątomierz z lupą 0 - 360°

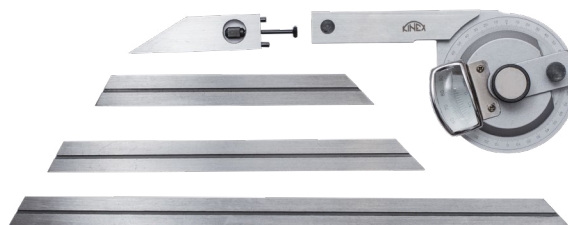

CODE		
1093	0 - 360°	5' (0,08°)

Úhloměr obloukový 180°
Protractor 0 - 180°
Kątomierz traserski 180°

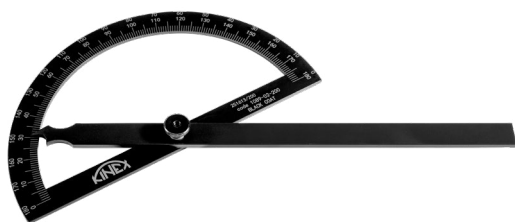

CODE	↔
1089-02-120	120x200 mm
1089-02-200	200x290 mm
1089-02-250	250x400 mm

Úhloměr obloukový 180° - NEREZ
Protractor 0 - 180° - STAINLESS STEEL
Kątomierz traserski 180° - STAL NIERDZEWNA

INOX

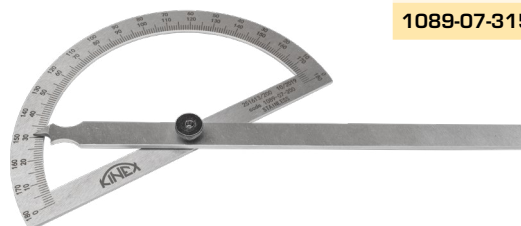

CODE	↔
1089-07-120	120x200 mm
1089-07-200	200x290 mm
1089-07-250	250x400 mm
1089-07-315	315x650 mm

Úhloměr pro tesaře digitální
Digital Protractor for Carpenters
Kątomierz traserski elektroniczny



1092-02-268



1092-02-254

CODE	
1092-02-268	0,05°
1092-02-254	0,1°



Měrky | Templates | Szczelinomierze

Měřidlo výšky dezénu pneumatik - digitální
Digital Tyre Gauge
Elektroniczny miernik wysokości bieżnika opon



CODE

1119-10	0 - 25 mm / 0-1"	± 0,2 mm
---------	------------------	----------

Měrka ventilová - sada
Feeler Gauge Set
Szczelinomierz - zestaw



CODE

ks | pcs | szt.

1130	0,02 - 0,2 mm	100 mm	10
1131	0,05 - 1 mm	100 mm	20
1131-02-032	0,03 - 1 mm	100 mm	32
1131-07-020	0,05 - 1 mm	100 mm	20
1132	0,05 - 1 mm	200 mm	20
1132-02-013	0,05 - 1 mm	200 mm	13
1133	1 - 2 mm	200 mm	11

Měrka radiusová - sada
Radius Gauge Set
Wzorce łuków - zestaw



CODE

ks | pcs | szt.

1140	r 1 - 7 mm	34
1141	r 7,5 - 15 mm	32
1142	r 15,5 - 25 mm	30

Měrka nemagnetická - sada (mosaz)
Nonmagnetic Feeler Gauge Set (brass)
Szczelinomierz niemagnetyczny - zestaw (mosiądz)



CODE

ks | pcs | szt.

1129-1	0,05 - 1 mm	100 mm	20
--------	-------------	--------	----

Měrka závitová
Screw Gauge Set
Wzorce zarysu gwintu



CODE

ks | pcs | szt.

1146	0,4 - 7 mm	20	Metric
1147	4 - 62 mm	28	Whitworth
1148	0,25 - 6 / 4 - 62 / 8 - 28 mm	58	M + W + G
1148-02-014	10 - 40 mm	14	US
1148-02-016	12 - 80 mm	16	UNF
1148-02-020	4 - 26 mm	20	BSF
1148-02-022	4 - 64 mm	22	UNC
1148-02-030	4 - 42 mm	30	US

Měrky | Templates | Szczelinomierze

Měrka ventilová v dóze
Feeler Gauge Tape
Szczelinomierz taśmowy



CODE			CODE		
1134-0,005/D	0,005 mm	5000x13 mm	1134-0,30/D	0,3 mm	5000x13 mm
1134-0,01/D	0,01 mm	5000x13 mm	1134-0,35/D	0,35 mm	5000x13 mm
1134-0,02/D	0,02 mm	5000x13 mm	1134-0,40/D	0,4 mm	5000x13 mm
1134-0,03/D	0,03 mm	5000x13 mm	1134-0,45/D	0,45 mm	5000x13 mm
1134-0,04/D	0,04 mm	5000x13 mm	1134-0,50/D	0,5 mm	5000x13 mm
1134-0,05/D	0,05 mm	5000x13 mm	1134-0,55/D	0,55 mm	5000x13 mm
1134-0,06/D	0,06 mm	5000x13 mm	1134-0,60/D	0,6 mm	5000x13 mm
1134-0,07/D	0,07 mm	5000x13 mm	1134-0,65/D	0,65 mm	5000x13 mm
1134-0,08/D	0,08 mm	5000x13 mm	1134-0,70/D	0,7 mm	5000x13 mm
1134-0,09/D	0,09 mm	5000x13 mm	1134-0,75/D	0,75 mm	5000x13 mm
1134-0,10/D	0,1 mm	5000x13 mm	1134-0,80/D	0,8 mm	5000x13 mm
1134-0,12/D	0,12 mm	5000x13 mm	1134-0,85/D	0,85 mm	5000x13 mm
1134-0,15/D	0,15 mm	5000x13 mm	1134-0,90/D	0,9 mm	5000x13 mm
1134-0,18/D	0,18 mm	5000x13 mm	1134-0,95/D	0,95 mm	5000x13 mm
1134-0,20/D	0,2 mm	5000x13 mm	1134-1,00/D	1 mm	5000x13 mm
1134-0,25/D	0,25 mm	5000x13 mm			

Šablona pro závitů
Thread Gauge
Wzorce gwintów

INOX



1122



1123



1124



1126

CODE

1122	Whitworth 55°
1123	metrický metric metryczny 60°
1124	Trapéz 2 - 12 mm, 30°
1126	univerzální universal uniwersalny

Šablona na měření úhlů soustružnických nožů
Template for measuring Turning Tools
Szablon do mierzenia kątów noży w tokarce



CODE

1127

Měrka zbrošení vrtáku
Twist Drill Grinding Gauge
Szablon do wiertel



CODE

1121 40°, 50°, 60°, 70°, 80°, 90°, 100°, 110°, 120°, 130°, 140°

Kuželová měrka pro měření průměru
Tapered Hole Gauge, flat
Miernik stożkowy do pomiaru średnicy

NEW



CODE

1138-02-015 1-15

Šablona pro broušení vrtáku
Template for Grinding Drill
Szablon do ostrzenia wiertel

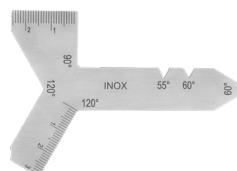

CODE

1125 55°, 60°



Měrky | Templates | Szczelinomierze

Měrka koutových svarů, analog, nerez
Welding Gauge
Spcinierz analogowy, stal nierdzewna

INOX

CODE

1120-07-020 60°,70°,80°,90° 0 - 20 mm 0,1 mm

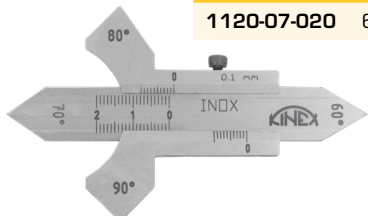

Měrka koutových svarů, digitalální
Digital Welding Gauge
Spcinierz digitalny

CODE

1120-05-011 60°,70°,80°,90° 0 - 20 mm 0,01 mm



Měrka na svary - 3 stupnice
Welding Gauge - 3 scales
Miernik spawu - 3 skale

CODE

1120-02-015

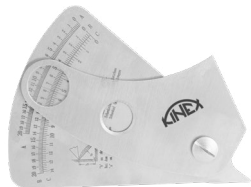

Měrka koutových svarů se zápornou stupnicí
Welding Gauge with negative scale
Spcinierz ze skalą ujemną

CODE

1120-02-016



Měrka na svary - CAMBRIDGE
Cambridge Welding Gauge
Miernik spawu - CAMBRIDGE

CODE

1120-02-013



Měrka koutových svarů
Welding Gauge
Spcinierz

CODE

1120-02-010 50°, 60°, 115°, 120°

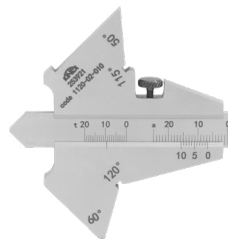

Šablona na koutové svary, 1-5
Welding Gauge, 1 - 5
Szablon spawu kątownego 1-5

CODE

1120-02-012 1 - 5



Posuvné měřátko na měření zkosení hran 45°
Caliper for chamfer 45°
Suwmiarka do pomiaru fazowania 45°



CODE

1128-02-007 0 - 70mm

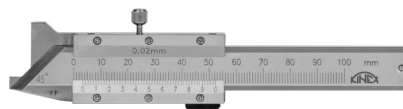

Měrka svarová háčková
Pipe Welding Gauge
Miernik spawu - hak

CODE

1120-02-014

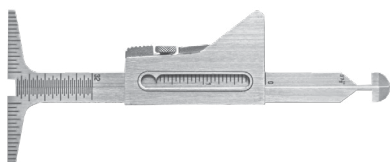

Měrka na měření průměru vrtáku
Drill Gauge
Miernik do pomiaru średnicy wiertła



CODE

1125-02-013

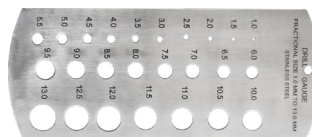

Stojánky | Stands | Podstawki

Stojánek magnetický UMAG
Magnetic Stand UMAG
Podstawka magnetyczna UMAG

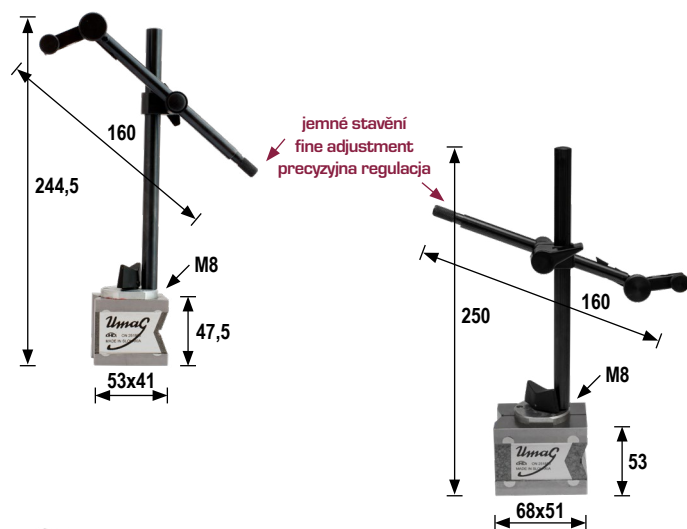

CODE	v papírovém obalu in paper case opakowanie AL	
1150	PN 25 1858.1	294N
1151	PN 25 1858.2	800N



CODE	v luxusním AL obalu in luxury AL case luksusowe AL opakowanie	
1150-1	PN 25 1858.1	294N
1151-1	PN 25 1858.2	800N

Stojánek magnetický UMAG, papírový obal
Magnetic Stand UMAG, paper wrapper
Podstawka magnetyczna UMAG, opakow. papierowe



CODE

1150-5	velký kloub velký kĺb duży przegub	160 mm	294 N
1150-6	ekonomický ekonomic ekonomiczny	160 mm	294 N
1150-7	ohybný kloub ohybný kĺb elastyczny przegub	360 mm	294 N

Stojánek magnetický UMAG - PROFI, papírový obal
Magnetic Stand UMAG - PROFI, paper wrapper
Podstawka magnetyczna UMAG - PROFI, opakow. papierowe

**NEW
LINE**



1150-61
1151-61

CODE

1150-61	294 N
1151-61	800 N



Stojánky | Stands | Podstawki

Měřicí granitový stojánek
Granite Stand with Arm
Precyzyjny stolik pomiarowy

**NEW
LINE**

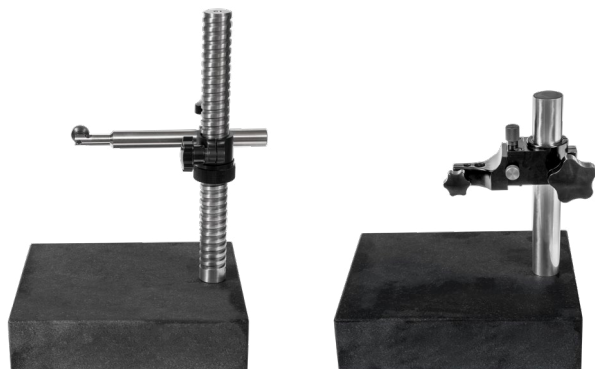

1150-04-250

1150-05-250

CODE

1150-04-250 250x200x65 mm

1150-05-250 250x200x65 mm

Měřicí stůl s jemným stavěním
Granite Stand with Fine Adjustment
Precyzyjny stolik pomiarowy z regulowanym remieniem

**NEW
LINE**



1150-07-150

CODE

1150-07-150 150x150 mm

Stojánek
Stand
Podstawka



1152

1153

CODE

1152 upínací | clamping | zaciskanie \varnothing 8 mm PN 25 1867 180 mm

1153 upínací | clamping | zaciskanie \varnothing 8 mm PN 25 1857 180 mm

Stolní odmagnetovač - demagnetizér
Demagnetizer
Demagnetyzer stołowy



CODE

1154-02-190 190x120x90 mm 80W/220V

1154-02-210 210x152x105 mm 150W/220V

Stojánek na mikrometry
Holder for Micrometer
Podstawka dla mikrometrów



1160

1160-02-117

CODE

1160

1160-02-117

Úchylkoměry | Indicators | Czujniki

Úchylkoměr číselníkový TOP QUALITY (vhodný pro kalibrace)
Dial Indicator TOP QUALITY (recommended for calibration)
Czujnik zegarowy - TOP QUALITY (nadaje się do kalibracji)

0,01

DIN
878

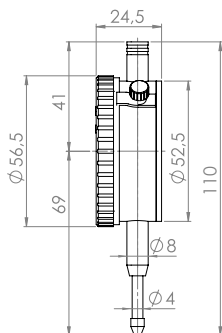

CODE		
1155-02-110	0 - 10 mm	0,01 mm

Úchylkoměr číselníkový
Dial Indicator
Czujnik zegarowy

0,001

0,01

DIN
878

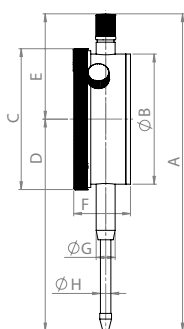

CODE			A	B	C	D	E	F	G	H
1155-02-010	0 - 10 mm	0,01 mm	110	52,5	56,5	69	41	24,5	8	4
1155-02-001	0 - 1 mm	0,001 mm	92	50	53	56	36	22	8	4
1155-02-025	0 - 25 mm	0,01 mm	124,5	55	59,5	84,5	40	24	8	4,4
1155-02-030	0 - 30 mm	0,01 mm	134	55	59,5	89,5	44,5	24	8	4,4
1155-02-005	0 - 5 mm	0,01 mm	83,5	37	41	50	33,5	21	8	4,4

Úchylkoměr číselníkový - s uchycením
Dial Indicator with lug
Czujnik zegarowy - z mocowaniem

0,01

DIN
878

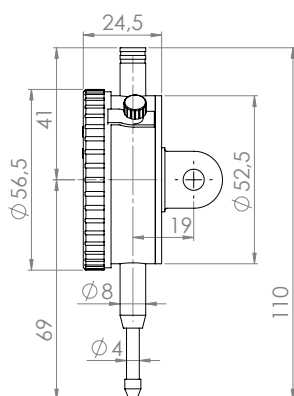

CODE		
1155-02-410	0 - 10mm	0,01 mm

SHOCK PROOF - odolný proti nárazu
SHOCK PROOF - shock-proof
SHOCK PROOF - wstrząsoodporny

CODE		
1155-02-710	0 - 10 mm	0,01 mm

Úchylkoměry | Indicators | Czujniki

Úchylkoměr číselníkový digitální ABSOLUTE ZERO, MAX/MIN, vhodné pro kalibrace
 Digital Indicator ABSOLUTE ZERO, MAX/MIN (recommended for calibration)
 Czujnik zegarowy elektroniczny ABSOLUTE ZERO, MAX/MIN, nadaje się do kalibracji



0,001

0,01



1155-05-010

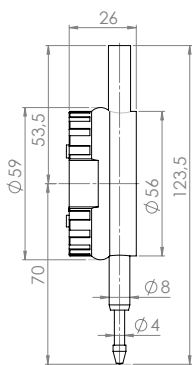

1155-05-001

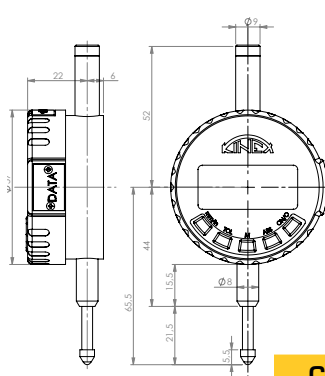

Dodáváno včetně protokolu o přeměření.
 Supplied with the Measuring Protocol.
 Dostarczamy wraz z protokołem o
 przemierzeniu.

CODE | D | Resolution

1155-05-010 0 - 12,7mm 60 0,01 mm M 2,5

1155-05-001 0 - 12,7mm 60 0,001 mm M 2,5



1155-052-001

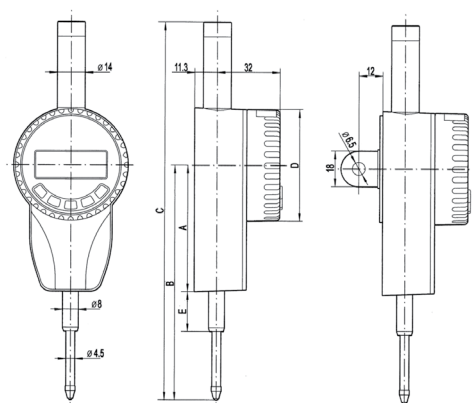

1155-35-001

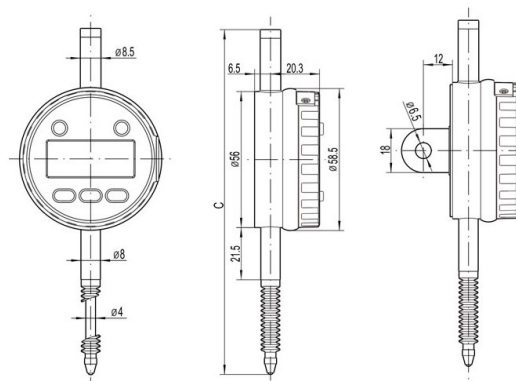

CODE | B | C | ø | Resolution

1155-35-010 0 - 12,7 mm 88,5 142,0 8 mm 0,01 mm M 2,5

1155-35-001 0 - 12,7 mm 88,5 140,5 8 mm 0,001 mm M 2,5

Interface pro připojení k PC
 PC Interface
 Interface do połączenia z komputerem



CODE

6040-05-9001 interface
 6040-05-901 nožní spínač | Footswitch | przełącznik nożny
 6040-05-902 kabel | cable | kabel

Úchylkoměry | Indicators | Czujniki

Úchylkoměr číselníkový digitální
Digital Indicator, metal housing
Czujnik zegarowy elektroniczny

0,001

0,01

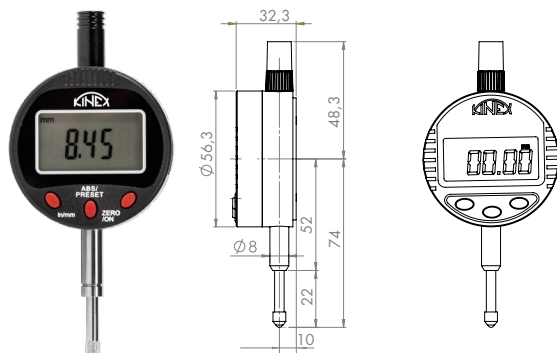

CODE

CODE	Range	Resolution	Thread
1155-25-010	0 - 12,7 mm	0,01 mm	M 2,5
1155-25-001	0 - 12,7 mm	0,001 mm	M 2,5

Měřicí můstek k digitálním úchylkoměrům
Measuring Bridge for Digital Digital Indicators
Mostek pomiarowy dla czujnika zegarowego (tylko elektroniczny)

CODE

1155-00-100



Úchylkoměr číselníkový páčkový
Dial Test Indicator
Czujnik zegarowy - Diatest

0,002

0,01

DIN
2270

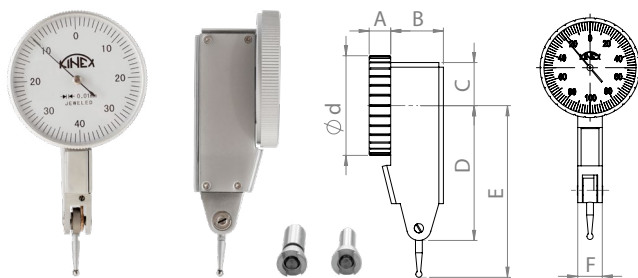

Náhradní dotyky k úchylkoměrům
Probe Tips
Zestawy wymiennych końcówek do czujników

CODE

1155-7 M2,5 mm

sada 22 ks
set 22 pcs
zestaw 22 szt.

HORIZONTÁLNÍ | HORIZONTAL | POZIOMY

CODE	Range	Resolution	d	A	B	C	D	E	F
1156-02-010	± 0,8 mm	0,01mm	39	7,5	17	14	44	56	8
1156-02-102	± 0,2 mm	0,002mm	32,5	7	17	14	44	56	8
1156-02-222	± 0,8 mm	0,01mm	39	7,5	17	14	44	56	8

1156-02-222 - karbidový hrot | carbide point | trzpień węglkowy



VERTIKÁLNÍ | VERTICAL | PIONOWY

CODE	Range	Resolution	d	A	B	D	E
1156-02-110	± 0,8 mm	0,01mm	39	6	16	57	75



Hmatadla | Internal & External Calipers | Cyrkle

Hmatadlo vnější
External Caliper
Macka zewnętrzną

ČSN
25 1210

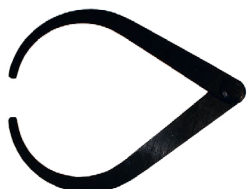

CODE		
2001	0 - 250 mm	150 mm
2002	0 - 340 mm	200 mm
2002-1	0 - 250 mm	250 mm
2003	0 - 510 mm	300 mm

Hmatadlo vnější
External Caliper
Macka zewnętrzną

ČSN
25 1212

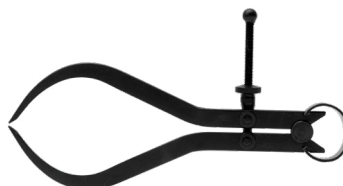

CODE		
2006	0 - 120 mm	150 mm
2007	0 - 165 mm	200 mm
2008	0 - 205 mm	250 mm
2009	0 - 250 mm	300 mm
2010	0 - 350 mm	500 mm

Hmatadlo vnitřní
Internal Caliper
Macka wewnętrzną sprężynowa

ČSN
25 1215



CODE		
2012	20 - 300 mm	150 mm
2013	25 - 400 mm	200 mm
2014	30 - 600 mm	300 mm

Hmatadlo vnitřní
Internal Caliper
Macka wewnętrzną sprężynowa

ČSN
25 1217



CODE		
2016	10 - 130 mm	150 mm
2017	12 - 165 mm	200 mm
2018	12 - 205 mm	250 mm
2019	12 - 250 mm	300 mm

Hloubkoměry | Depth Gauges | Głębokościomierze

Hloubkoměr bez nosu
Vernier Depth Gauge
Głębokościomierz bez nosa

0,02

ČSN
25 1280

DIN
862

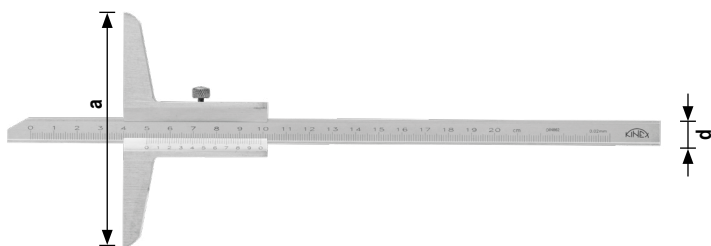

CODE		a [mm]	d [mm]	
2034-02-150	0 - 150 mm	100	11	0,02 mm
2034-02-200	0 - 200 mm	100	11	0,02 mm
2034-02-300	0 - 300 mm	100	11	0,02 mm
2034-02-500	0 - 500 mm	125	11	0,02 mm

Hloubkoměr s nosem
Vernier Depth Gauge with Nose
Głębokościomierz z nosem

0,02

ČSN
25 1282

DIN
862

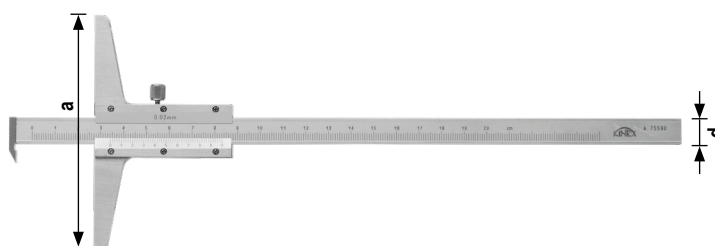

CODE		a [mm]	d [mm]	
2040-02-150	0 - 150 mm	100	11	0,02 mm
2040-02-200	0 - 200 mm	100	11	0,02 mm
2040-02-250	0 - 250 mm	100	11	0,02 mm
2040-02-300	0 - 300 mm	100	11	0,02 mm
2040-02-500	0 - 500 mm	100	11	0,02 mm

Hloubkoměry | Depth Gauges | Głębokościomierze

Hloubkoměr digitální bez nosu
Digital Depth Gauge
Głębokościomierz elektroniczny bez nosa

0,01

DIN
862



CODE	Range [mm]	a [mm]	b [mm]	d [mm]	Resolution
2050-05-150	0 - 150 mm	100	4	14	0,01 mm
2050-05-200	0 - 200 mm	100	4	14	0,01 mm
2050-05-300	0 - 300 mm	100	4	14	0,01 mm
2050-05-500	0 - 500 mm	120	7	15	0,01 mm
2050-05-600	0 - 600 mm	120	7	15	0,01 mm
2050-05-800	0 - 800 mm	150	7	18	0,01 mm



CODE	Range [mm]	a [mm]	b [mm]	d [mm]	Resolution
2050-25-150	0 - 150 mm	100	4	14	0,01 mm
2050-25-150	0 - 200 mm	100	4	14	0,01 mm
2050-25-150	0 - 300 mm	100	4	14	0,01 mm

NEW
LINE



S JEHLOU | WITH NEEDLE | Z IGLĄ

NEW
LINE

CODE	Range [mm]	a [mm]	b [mm]	d [mm]	Resolution
2052-05-150	0 - 150 mm	100	4	14	0,01 mm

Hloubkoměr digitální s nose
Digital Depth Gauge
Głębokościomierz elektroniczny z nose

0,01

DIN
862

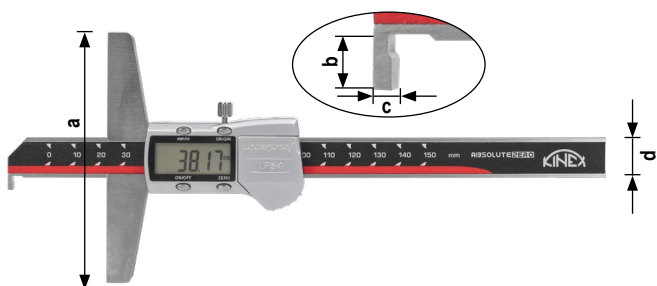

CODE	Range [mm]	a [mm]	b [mm]	c [mm]	d [mm]	Resolution
2051-05-150	0 - 150 mm	100	5	2	14	0,01 mm
2051-05-200	0 - 200 mm	100	5	2	14	0,01 mm
2051-05-300	0 - 300 mm	100	5	2	14	0,01 mm
2051-05-500	0 - 500 mm	120	8	3	15	0,01 mm





Kružidla | Spring Bow Dividers | Cyrkle

Kružidlo s pružinou
Spring Bow Divider
Cyrkiel sprężynowy

ČSN
25 5170

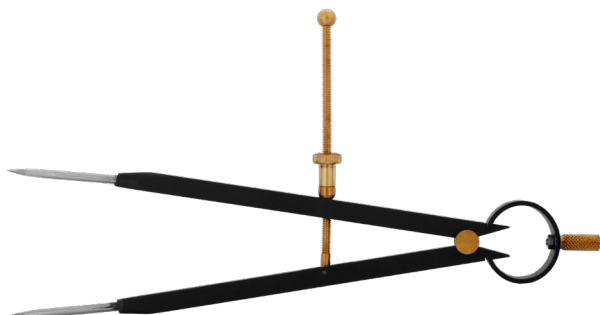

CODE		
2070-02-150	6 - 200 mm	150 mm
2070-02-200	10 - 300 mm	200 mm
2070-02-250	10 - 350 mm	250 mm
2070-02-300	10 - 450 mm	300 mm

Kružidlo bez mm dělení
Marking Gauge without mm Scale and Fine Adjustment
Cyrkiel nastawny



CODE		
2074	25 - 470 mm	500 mm
2075	25 - 960 mm	1000 mm
2074-1	prodloužení extension przedłużenie	500 mm
2075-1	prodloužení extension przedłużenie	1000 mm

Kružidlo ploché s mm dělením a jemným stavěním
Beam Trammel with 0,1mm graduation, Fine Adjustment
Cyrkiel nastawny z podziałą i precyzerem

DIN
862

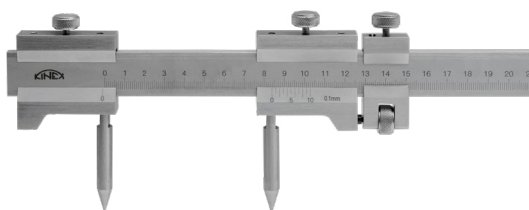

CODE		
2078	500 mm	0,1 mm
2078-1	1000 mm	0,1 mm
2078-2	1500 mm	0,1 mm
2078-3	2000 mm	0,1 mm

Nádrh
Surface Gauge
Rysik słupkowy traserski

ČSN
25 5315



CODE	
3001	250 mm
3002	400 mm

Výškoměry | Height Gauges | Wysokościomierze

Výškoměr analogový
Height Gauge
Wysokościomierz suwmiarkowy

0,02

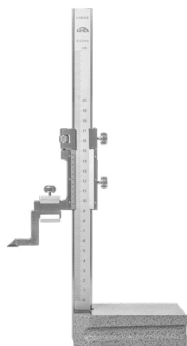

CODE	
3014-02-020	0 - 200 mm
3014-02-030	0 - 300 mm
3014-02-050	0 - 500 mm
3014-02-100	0 - 1000 mm

Výškoměr digitální
Digital Height Gauge
Wysokościomierz suwmiarkowy z odczytem cyfrowým

0,01



CODE	
3022-05-020	0 - 200 mm
3022-05-030	0 - 300 mm
3022-05-050	0 - 500 mm
3022-05-060	0 - 600 mm
3022-05-080	0 - 800 mm
3022-05-100	0 - 1000 mm

Výškoměr digitální s dvojitým ramenem
Digital Double Column Height Gauge
Wysokościomierz elektroniczny kolumnowy

0,01



CODE	
3020-02-030	0 - 300 mm
3020-02-050	0 - 500 mm
3020-02-060	0 - 600 mm



Rýsovací jehly a tužky | Scribers | Rysiki i ołówki

Rýsovací jehly
Scribers
Rysiki - węglkowe



CODE		ø	↔
3025	rovná straight równa	ČSN 25 5340.11	5 mm 150 mm
3026	zahnutá bent zakrzywiona	ČSN 25 5340.21	5 mm 200 mm
3026-30	celokarbidová fully carbide monolit		4 mm 160 mm

Rýsovací tužky
Drawing Pencils
Ołówki - węglkowe

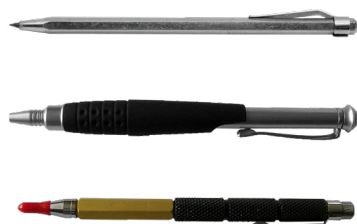

CODE		↔
3025-2	s karbidovým hrotem with carbide tip z koňcówką węglkową	150 mm
3025-3	s vysouvacím karbidovým hrotem, gum. drřadlo with extendable carbide tip, rubber grip z koňcówką węglkową i gumovým uchwytem	140 mm
3025-4	s karbidovým oboustranným hrotem a dűlćikem carbide two-sided point, punch z obustronną koňcówką węglkową	140 mm

Tužka rýsovací na sklo a plech 3263
Ceruzka rysowacie na sklo, typ 3263/180mm
Ołówek do trasowania na szkle i blachach 3263

KOP-MAK HARTNITE 180mm 3263

CODE	typ	↔
9038	3262	175 mm

Tužka tesařská
Carpenter Pencil
Ołówek stolarski



CODE	tvrdost tvrdost twardość	typ	↔
9030	1	1536	175 mm
9031	2	1536	175 mm
9033	2	1537	250 mm

Tužka rýsovací na kámen
Pencil for Stone
Ołówek do trasowania kamienia



CODE	typ	↔
9035	1536	175 mm

Vratidla závitníků a závitových oček | Tap Wrenches | Pokrętła do gwint. i oprawy do narzynek

Vratidlo na závitníky pro čtyřhran
Tap Holder
Pokrętła do gwintowników

ČSN
24 1126



CODE			#
3040-02-045	2,00 - 4,50 mm	M2 - M7	1
3047-02-710	2,50 - 7,10 mm	M3 - M12	
3045-02-630	3,15 - 6,30 mm	M4 - M11	2
3042-02-900	3,55 - 9,00 mm	M6 - M14	3
3044-02-160	5,60 - 16,00 mm	M9 - M27	4
3046-02-180	6,00 - 18,00 mm	M10 - M30	
3048-02-315	14,00 - 31,50 mm	M24 - M52	5

Vratidlo na závitníky pro čtyřhran
Tap Holder
Pokrętła do gwintowników

DIN

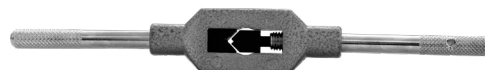

CODE	
3039-02-130	M1 - M8
3039-02-188	M3 - M10
3039-02-280	M4 - M12
3039-02-375	M5 - M20
3039-02-500	M9 - M27
3039-02-750	M13 - M52

Držák na závitová očka
Die Holder
Oprawa do narzynek

ČSN
24 1520



CODE		
3052	16 mm	M1 - M2,5
3053	20 mm	M3 - M6
3054	25 mm	M7 - M9
3055	30 mm	M10 - M11
3056	38 mm	M12 - M15

CODE		
3057	45 mm	M16 - M20
3058	55 mm	M22 - M26
3059	65 mm	M27 - M36
3059-1	75 mm	M39 - M42
3060	90 mm	M45 - M52

Nástavce závitníků | Tap Extensions | Przedłużacze gwintowników

Nástavce závitníků
Tap Extension
Przedłużacze gwintowników



ČSN
25 1151

CODE		↔
3049-06-315	3,15	90 mm
3049-06-355	3,55	95 mm
3049-06-400	4,00	100 mm
3049-06-500	5,00	110 mm
3049-06-560	5,60	115 mm
3049-06-620	6,20	125 mm
3049-06-630	6,30	120 mm
3049-06-710	7,10	125 mm
3049-06-900	9,00	135 mm

DIN

CODE		↔
3049-08-210	2,10	60 mm
3049-08-240	2,40	70 mm
3049-08-270	2,70	80 mm
3049-08-300	3,00	80 mm
3049-08-340	3,40	90 mm
3049-08-380	3,80	100 mm
3049-08-430	4,30	105 mm
3049-08-490	4,90	110 mm
3049-08-550	4,90	110 mm
3049-08-620	6,20	120 mm
3049-08-800	8,00	125 mm
3049-08-110	11,00	150 mm
3049-08-120	12,00	155 mm
3049-08-130	13,00	165 mm



Úhelníky | Squares | Kątowniki

Úhelník přesný, plochý
Precision Flat Square
Kątownik precyzyjny płaski

DIN
875

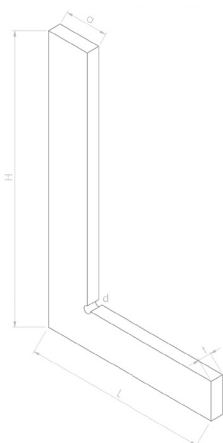

0
class

CODE	H [mm]	L [mm]	a [mm]	t [mm]
4033-02-007	75	50	17	6
4033-02-010	100	70	21	6
4033-02-015	150	100	26	8
4033-02-020	200	130	26	8
4033-02-025	250	160	31	8
4033-02-030	300	200	32	8
4033-02-040	400	250	40	8
4033-02-050	500	330	50	10
4033-02-060	600	400	50	10
4033-02-075	750	500	60	12
4033-02-100	1000	660	70	15

I
class

CODE	H [mm]	L [mm]	a [mm]	t [mm]
4033-12-007	75	50	17	6
4033-12-010	100	70	21	6
4033-12-015	150	100	26	8
4033-12-020	200	130	26	8
4033-12-025	250	160	31	8
4033-12-030	300	200	32	8
4033-12-040	400	250	40	8
4033-12-050	500	330	50(60)	10(12)
4033-12-060	600	400	50(60)	10(12)
4033-12-075	750	500	50(60)	10(12)
4033-12-100	1000	660	50(60)	10(12)

II
class

CODE	H [mm]	L [mm]	a [mm]	t [mm]
4033-22-007	75	50	17	6
4033-22-010	100	70	21	6
4033-22-015	150	100	26	8
4033-22-020	200	130	26	8
4033-22-025	250	160	31	8
4033-22-030	300	200	32	8
4033-22-040	400	200	40	8
4033-22-050	500	250	50	10(12)
4033-22-060	600	300	50	10(12)
4033-22-075	750	375	50	10(12)
4033-22-100	1000	500	50	10(12)
4033-22-150	1500	750	60	12
4033-22-200	2000	1000	60	12
4033-22-250	2500	1250	60	12

Úhelníky | Squares | Kątowniki

Úhelník přesný, příložný
Precision Try Square
Kątownik precyzyjny ze stopką

DIN
875



0
class

CODE	H [mm]	L [mm]	a [mm]	t [mm]	b [mm]	c [mm]
4034-02-007	75	50	17	6	16	6
4034-02-010	100	70	21	6	16	6
4034-02-015	150	100	26	8	20	8
4034-02-020	200	130	26	8	20	8
4034-02-025	250	160	31	8	25	8
4034-02-030	300	200	32	8	30	8
4034-02-040	400	250	40	8	30	8
4034-02-050	500	330	50	10	40	8
4034-02-060	600	400	50	10	40	8
4034-02-075	750	500	60	12	40	8
4034-02-100	1000	660	70	15	40	8

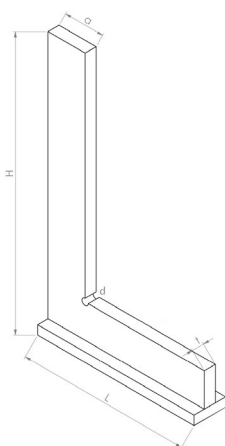

I
class

CODE	H [mm]	L [mm]	a [mm]	t [mm]	b [mm]	c [mm]
4034-12-007	75	50	17	6	16	6
4034-12-010	100	70	21	6	16	6
4034-12-015	150	100	26	8	20	8
4034-12-020	200	130	26	8	20	8
4034-12-025	250	160	31	8	25	8
4034-12-030	300	200	32	8	30	8
4034-12-040	400	250	40	8	30	8
4034-12-050	500	330	50 (60)	10 (12)	40	8
4034-12-060	600	400	50 (60)	10 (12)	40	8
4034-12-075	750	500	50 (60)	10 (12)	40	8
4034-12-100	1000	660	50 (60)	10 (12)	40	8

II
class

CODE	H [mm]	L [mm]	a [mm]	t [mm]	b [mm]	c [mm]
4034-22-007	75	50	17	6	16	6
4034-22-010	100	70	21	6	16	6
4034-22-015	150	100	26	8	20	6
4034-22-020	200	130	26	8	20	6
4034-22-025	250	160	31	8	25	8
4034-22-030	300	200	32	8	30	8
4034-22-040	400	200	40	8	30	8
4034-22-050	500	250	50	10 (12)	40	8
4034-22-060	600	300	50	10 (12)	40	8
4034-22-075	750	375	50	10 (12)	40	8
4034-22-100	1000	500	50	10 (12)	40	8
4034-22-150	1500	750	60	12	50	10
4034-22-200	2000	1000	60	12	50	10
4034-22-250	2500	1250	60	12	50	10



Úhelníky | Squares | Kątowniki

Úhelník přesný, plochý - NEREZ

Precision Flat Square - Stainless steel

Kątownik precyzyjny płaski - STAL NIERDZEWNA

INOX

DIN
875

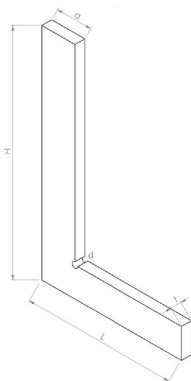

0
class

CODE	H [mm]	L [mm]	a [mm]	t [mm]
4033-07-007	75	50	17	6
4033-07-010	100	70	21	6
4033-07-015	150	100	26	8
4033-07-020	200	130	26	8
4033-07-025	250	165	31	8
4033-07-030	300	200	32	8
4033-07-040	400	265	40	8
4033-07-050	500	330	50	10

I
class

CODE	H [mm]	L [mm]	a [mm]	t [mm]
4033-17-007	75	50	17	6
4033-17-010	100	70	21	6
4033-17-015	150	100	26	8
4033-17-020	200	130	26	8
4033-17-025	250	165	31	8
4033-17-030	300	200	32	8
4033-17-040	400	265	40	8
4033-17-050	500	330	50	10 (12)

DALŠÍ ROZMĚRY NA ZAKÁZKU
OTHER SIZES ON REQUEST
INNE WYMIARY NA ZAMÓWIENIE

Úhelník přesný, příložný - NEREZ

Precision Try Square - Stainless steel

Kątownik precyzyjny ze stopką - STAL NIERDZEWNA

INOX

DIN
875

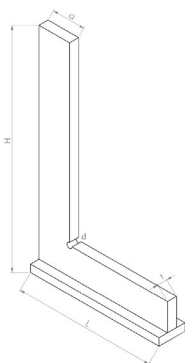

0
class

CODE	H [mm]	L [mm]	a [mm]	t [mm]
4034-07-007	75	50	17	6
4034-07-010	100	70	21	6
4034-07-015	150	100	26	8
4034-07-020	200	130	26	8
4034-07-025	250	165	31	8
4034-07-030	300	200	32	8
4034-07-040	400	265	40	8
4034-07-050	500	330	50	10

I
class

CODE	H [mm]	L [mm]	a [mm]	t [mm]
4034-17-007	75	50	17	6
4034-17-010	100	70	21	6
4034-17-015	150	100	26	8
4034-17-020	200	130	26	8
4034-17-025	250	165	31	8
4034-17-030	300	200	32	8
4034-17-040	400	265	40	8
4034-17-050	500	330	50	10 (12)

DALŠÍ ROZMĚRY NA ZAKÁZKU
OTHER SIZES ON REQUEST
INNE WYMIARY NA ZAMÓWIENIE

Úhelníky | Squares | Kątowniki

Úhelník příložný přesný - NOVÝ TYP

Precision Universal Square

Kątownik precyzyjny ze stopką - Nowy typ

DIN
875

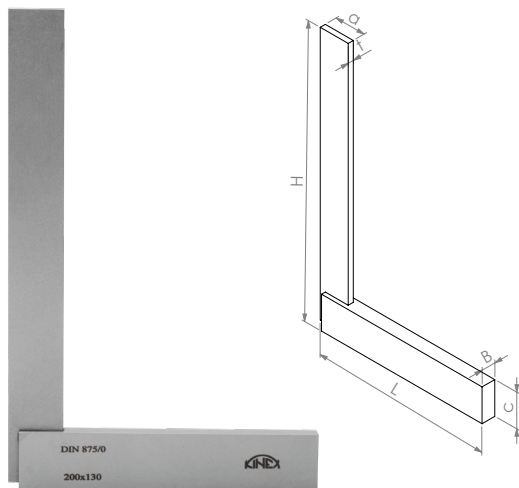

0
class

CODE	a [mm]	t [mm]	C [mm]	B [mm]	H [mm]	L [mm]
4026-02-006	16	4	16	10	60	40
4026-02-007	16	4	16	10	75	50
4026-02-010	16	4	20	10	100	70
4026-02-015	20	4	25	10	150	100
4026-02-020	22	4	25	10	200	130
4026-02-025	23	4	26	12	250	165
4026-02-030	24	4	27	12	300	200
4026-02-040	26	4	32	16	400	265
4026-02-050	30 - 32	4	32	16	500	330



I
class

CODE	a [mm]	t [mm]	C [mm]	B [mm]	H [mm]	L [mm]
4026-12-006	16	4	16	10	60	40
4026-12-007	16	4	16	10	75	50
4026-12-010	16	4	20	10	100	70
4026-12-015	20	4	25	10	150	100
4026-12-020	22	4	25	10	200	130
4026-12-025	23	4	26	12	250	165
4026-12-030	24	4	27	12	300	200
4026-12-040	26	4	32	16	400	265
4026-12-050	30 - 32	4	32	16	500	330
4026-12-060	30 - 32	4	32	16	600	400
4026-12-154	sada set zestaw 60, 75, 100, 150					
4026-12-250	sada set zestaw 100, 150, 200, 250					

NEW

Ultralehký úhelník přesný, příložný KINEX ICONIC Labo (carbon/titan)

Ultralight Precise Square ICONIC Labo (carbon/titan)

Ultralekki kątownik KINEX ICONIC Labo (carbon/titan)

DIN
875



VHODNÝ PRO ROBOTICKÁ PRACOVÍŠTĚ
SUITABLE FOR ROBOTIC WORKPLACES
NADAJE SIĘ DO ZAUTOMATYZOWANEJ STACJI ROBOCZEJ



CODE	a [mm]	L [mm]
4026-28-006	12x1,5 mm	60x40 mm



Úhelníky | Squares | Kątowniki

Úhelník přesný plochý typ "Au"
Precision Flat Square "Au"
Kątownik precyzyjny płaski typ "Au"

ČSN
25 5103 **DIN**
875

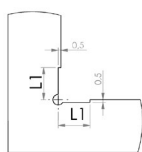
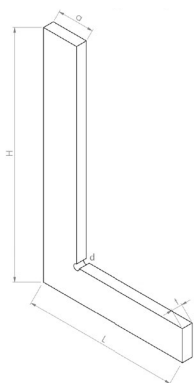

ČSN I

DIN II

CODE	H [mm]	L [mm]	a [mm]	t [mm]	L1 [mm]
4034	63	40	17	6	-
4035	100	63	21	6	-
4036	160	100	26	8	-
4037	250	160	31	8	-
4038	400	250	40	8	18
4039	630	400	50	12	22
4040	750	375	50	10 (12)	22
4041	1000	500	50	10 (12)	22
4042	1500	750	60	12	-
4043	2000	1000	60	12	-

Úhelník přesný plochý kalený typ "A"
Precision Flat Square Hardened "A"
Kątownik precyzyjny płaski hartowany typu "A"

ČSN
25 5103

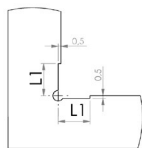
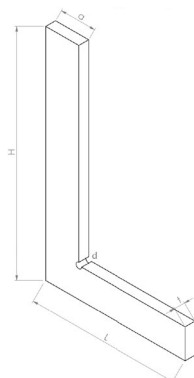

ČSN I

CODE	H [mm]	L [mm]	a [mm]	t [mm]	L1 [mm]
4045	63	40	17	6	-
4046	100	63	21	6	-
4047	160	100	26	8	-
4048	250	160	31	8	-
4049	400	250	40	8	18

Úhelník přesný příložný typ "Bu"
Precision Try Square "Bu"
Kątownik precyzyjny ze stopką typu "Bu"

DIN
875 **ČSN**
25 5103

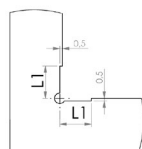
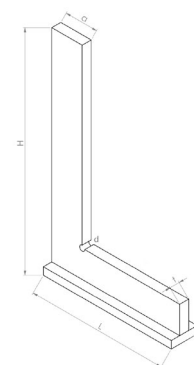

ČSN II

DIN II

CODE	H [mm]	L [mm]	a [mm]	t [mm]	L1 [mm]
4051	63	40	17	6	-
4052	100	63	21	6	-
4053	160	100	26	8	-
4054	250	160	31	8	-
4055	400	250	40	8	18
4056	630	400	50	12	22
4057	750	375	50	10 (12)	22
4057-1	1000	500	50	10 (12)	22
4057-2	1500	750	60	12	-
4057-3	2000	1000	60	12	-

Úhelníky | Squares | Kątowniki

Úhelník přesný příložný kalený typ "B"
Precision Try Square Hardened "B"
Kątownik precyzyjny ze stopką hartowany typu "B"

ČSN
25 5103

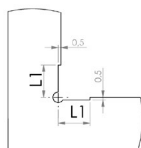
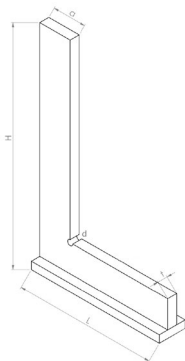

ČSN
II

CODE	H [mm]	L [mm]	a [mm]	t [mm]	L1 [mm]
4058	63	40	17	6	-
4059	100	63	21	6	-
4060	160	100	26	8	-
4061	250	160	31	8	-
4061-1	400	250	40	8	18

Úhelník zámečnický plochý
Flat Square
Kątownik płaski

PN
25 5120

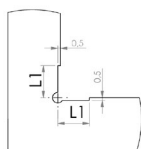
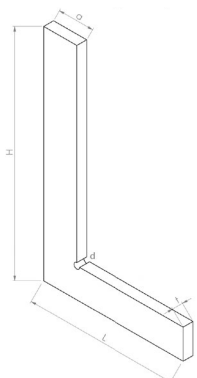

CODE	H [mm]	L [mm]	a [mm]	t [mm]	L1 [mm]
4010	100	63	17	4	-
4011	160	100	26	5	-
4012	250	160	26	5	-
4013	400	250	32	6	18
4014	630	400	40	8	22
4015	750	375	40	8	22
4016	1000	500	40	8	22

Úhelník zámečnický příložný
Try Square
Kątownik ze stopką

PN
25 5124

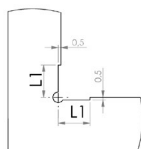
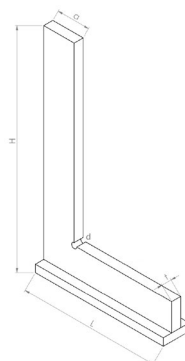

CODE	H [mm]	L [mm]	a [mm]	t [mm]	L1 [mm]
4020	100	63	17	4	-
4021	160	100	26	5	-
4022	250	160	26	5	-
4023	400	250	32	6	18
4024	630	400	40	8	22
4025	750	375	40	8	22
4025-1	1000	500	40	8	22



Úhelníky | Squares | Kątowniki

Úhelník s pružným ramenem a mm dělením
Flexible Precision Square with mm graduation
Kątownik z elastycznym ramieniem i mm skalą

ČSN
25 5133

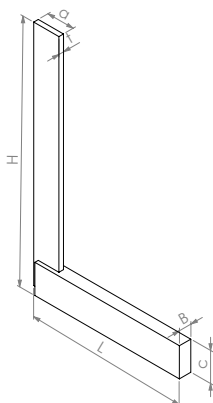
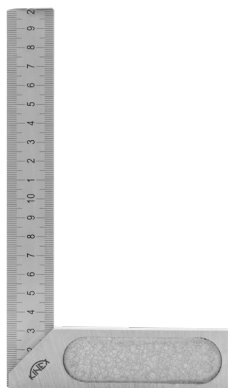

CODE	a [mm]	t [mm]	c [mm]	B [mm]	↔
4031	30	1	15	5	200x120 mm
4032	30	1	15	5	250x150 mm

Úhelník BLACK COAT s mm dělením
Square BLACK COAT with mm graduation
Kątownik BLACK COAT - skala mm

AI

STEEL

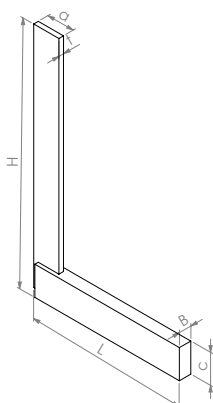
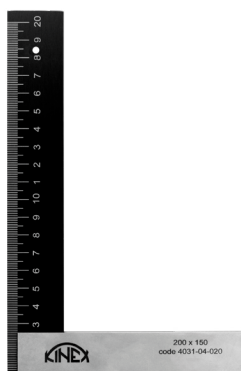

hliník/ocel | hliník/ocel' | aluminium/stal

CODE	a [mm]	t [mm]	c [mm]	B [mm]	↔
4031-03-020	32	5	25	10	200x130 mm
4031-03-025	32	5	26	12	250x165 mm
4031-03-030	32	5	27	12	300x200 mm

Úhelník AL s mm dělením
Square AL with mm graduation
Kątownik AL - skala mm



Magnetický úhelník na sváření
Magnetic Welding Clamp
Kątownik do spawania



CODE	↔
4031-04-025	250x140 mm
4031-04-030	300x170 mm
4031-04-040	400x200 mm



CODE	↔
4064-08-010	100 x 65 30, 45, 60, 75, 90°
4064-08-011	110 x 95 30, 90, 135°

Úhelníky | Squares | Kątowniki

Úhelník nožový - přesný kalený, typ E
Precision Knife Edge Square "E"
Kątownik krawędziowy - prec. hartowany, typ E

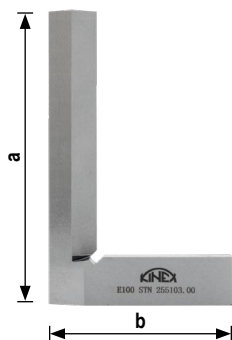

CODE		a [mm]	b [mm]
4001	7x11 / 11x11 mm	63	35
4002	11x17 / 14x17 mm	100	63
4003	12x20 / 20x20 mm	160	100
4004	12x20 / 20x20 mm	200	130
4005	12x20 / 20x20 mm	250	160

Úhelník nožový - přesný kalený, typ C
Precision Knife Edge Square "C"
Kątownik krawędziowy - prec., hartowany, typ C

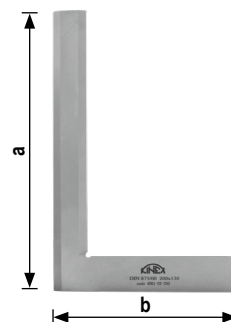

CODE		a [mm]	b [mm]
4001-03-025	6x3,5 / 5x3,5 mm	25	20
4001-03-040	8x3,5 / 5x3,5 mm	40	28
4001-03-063	5,5x16 mm	63	40
4001-03-075	5,5x16 mm	75	50
4001-03-100	5,5x20 mm	100	70
4001-03-150	7,7x25 mm	150	100
4001-03-200	7,7x25 mm	200	130
4001-03-250	7,7x30 mm	250	160
4001-03-300	8x40 mm	300	200

Úhelník svařovaný příložený dílenský - úprava pozink
Workshop Flat Square
Kątownik ślusarski ze stopką - wykończenie galwanizowane



CODE	H [mm]	L [mm]	a [mm]	t [mm]
4020-30	100	70	20	5
4020-31	150	100	20	5
4020-32	200	130	20	5
4020-33	250	160	25	5
4020-34	300	180	25	5
4020-35	400	230	30	5
4020-36	500	280	30	5
4020-37	600	330	30	5
4020-38	750	375	30	5
4020-39	1000	500	30	5

Toto provedení úhelníků není určeno ke kalibraci.
Not intended for calibration.
Kątownik nie jest przeznaczony do kalibracji.

Úhelník tesařský KINEX BLACK COAT
Flexible Square KINEX BLACK COAT
Kątownik stolarski KINEX BLACK COAT



CODE		
4028	30x1 / 32x5 mm	400x230 mm
4029	30x1 / 32x5 mm	750x375 mm
4030	30x1 / 32x5 mm	1000x375 mm

Úhelník tesařský s mm dělením KINEX BLACK COAT
Flexible Square with mm graduation KINEX BLACK COAT
Kątownik stolarski ze skalą KINEX BLACK COAT



CODE		
4028-1	30x1 / 32x6 mm	500x230 mm
4029-1	30x1 / 32x6 mm	750x375 mm
4030-1	30x1 / 32x6 mm	1000x375 mm



Úhelníky | Squares | Kątowniki

Úhelník plochý 45°
Precision Flat Square 45°
Kątownik płaski 45°

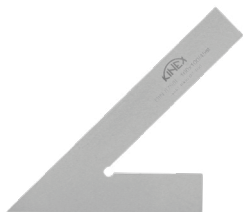

CODE	↔	↔
4006-02-120	20x5 mm	120x 80 mm
4006-02-160	20x5 mm	160x100 mm
4006-02-200	25x5 mm	200x130 mm
4006-02-300	25x5 mm	300x175 mm

Úhelník příložný 45°
Precision Try Square 45°
Kątownik ze stopką 45°



CODE	↔	↔
4007-02-120	20x5 mm	120x 80 mm
4007-02-160	20x5 mm	160x100 mm
4007-02-200	25x5 mm	200x130 mm
4007-02-300	25x5 mm	300x175 mm

Vyrábíme a dodáváme úhelníky s různými úhly (60°, 120°, 135°)
We manufacture and supply squares with different angles (60°, 120°, 135°)
Produkujemy i dostarczamy kątowniki z różnymi kątami (60°, 120°, 135°)

Trojúhelník
Triangle
Trójkąt



CODE	↔	↔
4080	45°	250 mm
4085	60°	250 mm

Úhelník středící
Centre Square
Kątownik centrujący

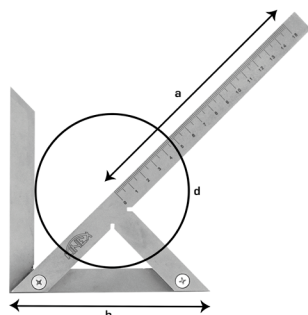

CODE	a [mm]	d [mm]	h [mm]
4062	100	70	90
4062-1	150	130	180
4062-2	200	150	210
4062-3	300	180	250
4062-4	400	250	250
4062-5	500	330	250

Úhelník přírubový, síla 30x5mm
Flange Square
Kątownik do ustawiania kołnierzy 30x5mm

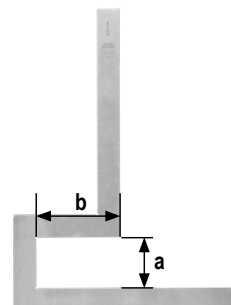

CODE	↔	a [mm]	b [mm]
4063-10	300x300 mm	65	105
4063-11	400x400 mm	65	115
4063-12	500x500 mm	70	125
4063-13	600x600 mm	70	125
4063-14	800x800 mm	95	135

Vodováhy | Spirit levels | Poziomice

Vodováha digitální
Digital Spirit Level / Inclinometer
Poziomica elektroniczna



5017-02-050



5017-02-065



5017-05-150



5017-97-150

CODE	Resolution	Features
5017-02-050	0,1°	bez libely without vial bez fiolek
5017-02-065	0,01°	s libelou with vial fiołką
5017-05-150	0,01°	
5017-97-150	0,01°	s bluetooth with bluetooth z bluetooth

Vodováha hadicová
Hose Level
Poziomica węzowa (para - szkło)



5035-3



5036

CODE	Quantity	Material
5036	pár pair para	plast plastic plastikowy
5035-3	sada set zestaw	10 m
5035-4	sada set zestaw	15 m

Vodováha k ustavení sloupků s magnetem - plast
Hose Level
Poziomica plastikowa z magnesem



CODE
5036-5

Vodováha digitální zednická
Digital Level with Laser
Poziomica elektroniczna



CODE	Resolution	Vials	Features
5017-02-600	0,1°	2 libely 2 vials 2 fiołki	s laserem (30m) with laser (30m) z laserem (30m)

Vodováha zednická s magnetem
Spirit Level with Magnets and 3 Vials
Poziomica z magnesem i 3 ampułkami



CODE	Resolution	Length
5018-0	0,5 mm / 1 m	400 mm
5018-1	0,5 mm / 1 m	600 mm
5018-2	0,5 mm / 1 m	800 mm
5018-3	0,5 mm / 1 m	1000 mm
5018-4	0,5 mm / 1 m	1200 mm
5018-5	0,5 mm / 1 m	1500 mm
5018-6	0,5 mm / 1 m	2000 mm

Olovnice
Plumb
Poziomica pionowa



5036-02-008



5036-08-006

CODE	Length
5036-02-008	8 m
5036-08-006	6 m



Vodováhy | Spirit levels | Poziomice

Vodováha přesná strojní NEW MODEL
High Precision Spirit Level NEW MODEL
Poziomica liniarowa NEW MODEL



CODE		↔
5050-02-150	0,02 mm	150x42x40 mm
5050-02-200	0,02 mm	200x42x40 mm
5050-02-250	0,02 mm	250x42x40 mm
5050-02-300	0,02 mm	300x42x40 mm
5050-02-400	0,02 mm	400x42x40 mm
5050-02-500	0,02 mm	500x42x40 mm

Vodováha přesná strojní s magnetickým upínáním NEW MODEL
High-precision Longitude Spirit Level, Magnetic clamping NEW MODEL
Poziomica liniarowa z mocowaniem magnetycznym NEW MODEL

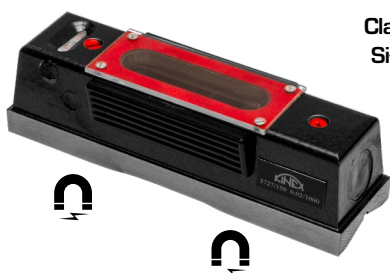

Upínací síla 60 N (6 kg)
Clamping force 60 N (6 kg)
Siła zaciskania 60 N (6 kg)

CODE		↔
5051-02-150	0,02 mm	150x42x40 mm
5051-02-200	0,02 mm	200x42x40 mm
5051-02-250	0,02 mm	250x42x40 mm
5051-02-300	0,02 mm	300x42x40 mm

Vodováha přesná strojní
Precision Cross Short Level
Poziomica liniarowa



Vodováha přesná strojní
Precision Longitude Spirit Level
Poziomica liniarowa



CODE		↔
5110-02-100	0,2 mm	100x40x32 mm
5110-02-150	0,2 mm	150x40x32 mm



CODE		↔
5115-02-150	0,2 mm	150x42x40 mm
5115-02-200	0,2 mm	200x42x40 mm
5115-02-250	0,2 mm	250x42x40 mm
5115-02-300	0,2 mm	300x42x40 mm
5115-02-400	0,2 mm	400x42x40 mm

Vodováhy | Spirit levels | Poziomice

Vodováha přesná strojní NEW MODEL
High-precision Spirit Level NEW MODEL
Poziomnica ramowa NEW MODEL



Vodováha přesná strojní s magn. upínáním
High-precision Longitude Spirit Level Magnetic
Poziomnica ramowa z mocowaniem magnetycznym



Upínací síla 60 N (6 kg)
Clamping force 60 N (6 kg)
Siła zaciskania 60 N (6 kg)



CODE		
5090-02-150	0,02 mm	150x150x44 mm
5090-02-200	0,02 mm	200x200x44 mm
5090-02-250	0,02 mm	250x250x44 mm
5090-02-300	0,02 mm	300x300x44 mm

CODE		
5091-02-150	0,02 mm	150x150x44 mm
5091-02-200	0,02 mm	200x200x44 mm
5091-02-250	0,02 mm	250x250x44 mm
5091-02-300	0,02 mm	300x300x44 mm

Vodováha přesná strojní NEW MODEL
High-precision Spirit Level NEW MODEL
Poziomnica ramowa NEW MODEL



CODE		
5080-02-100	0,2 mm	100x100x25 mm
5080-02-150	0,2 mm	150x150x43 mm
5080-02-200	0,2 mm	200x200x43 mm
5080-02-250	0,2 mm	250x250x43 mm
5080-02-300	0,2 mm	300x300x43 mm



Vodováhy | Vodováhy | Poziomice centrujące

Kruhová libela - plast
Circular Vial - plastic
Poziomica centrująca - plastikowa

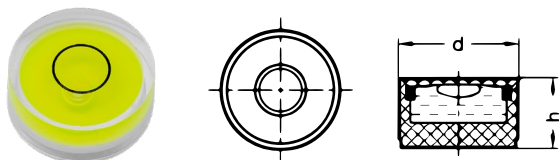

CODE	d [mm]	h [mm]
5022-01-025	25	10,5

Kruhová libela s upevňovacími otvory - plast
Circular Vial with mounting holes - plastic
Plastikowa poziomica centrująca z otworami montażowymi

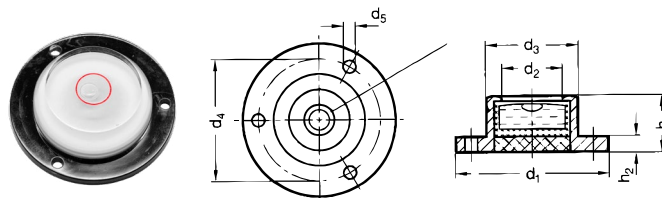

CODE	d1	d2	d3	d4	d5	h1	h2
5022-02-030	40	24	30	36	3,5	11	2,5

Kruhová libela s upevňovacími otvory stříbrná - hliník
Circular Vial with Mounting Holes - anodized silver
Aluminiowa poziomica centrująca z otworami montażowymi - srebrna

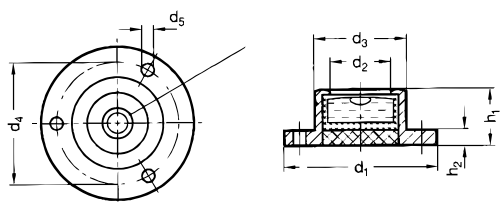
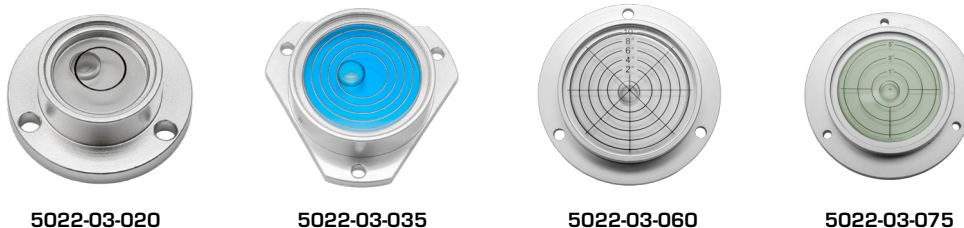

CODE	Angle	d1	d2	d3	d4	d5	h1	h2
5022-03-020	5' - 60' / 2 mm	30	16	20	25	3,5	11	3,5
5022-03-035	5' - 60' / 2 mm	-	28	35	46	3,5	13	3,5
5022-03-060	± 10°	80	57	62	70	5,0	15	5,0
5022-03-075	± 5°	100	60	75	85	5,0	20	8,0

Kruhová libela s upevňovacími otvory černá - hliník
Circular Vial with Mounting Holes - anodized black
Aluminiowa poziomica centrująca z otworami montażowymi - czarna

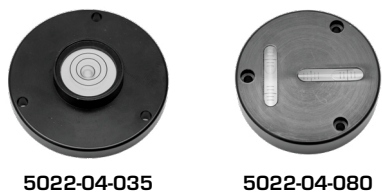
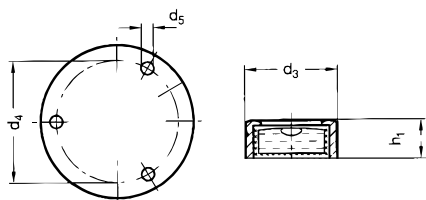

CODE	Angle	d1	d2	d3	d4	d5	h1	h2
5022-04-035	30' / 2 mm (9 mm/m)	80	28	35	70	5,0	18	9
5022-04-080	-	-	-	80	66	5,5	18	-

Libela plastová
Plastic Vial
Fiolka plastikowa

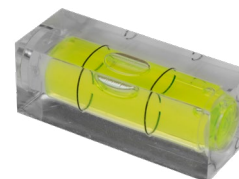

CODE	Material	Dimensions
5022-1	plast plastic	40x15x15 mm

Posuvná měřítka | Calipers | Suwmiarki

Posuvné měřítko s hloubkoměrem a vnitřním měřením, aretace šroubkem

Vernier Caliper with Locking Screw and Depth Gauge

Suwmiarka analogowa z pomiarem głębokości i pomiarem wewnętrznym ze śrubą zabezpieczającą

DIN
862

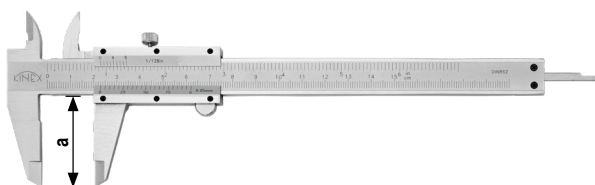

CODE			a [mm]	
6000	0,02 mm	150 mm	40	šroub. skrutkov. śruba nonius
6000-1	0,05 mm+inch	150 mm	40	šroub. skrutkov. śruba nonius
6000-2	0,02 mm+inch	150 mm	40	monoblok, INOX
6000-25	0,02 mm+inch	160 mm	40	monoblok, INOX
6000-26	0,05 mm+inch	160 mm	40	monoblok, INOX
6000-7	0,02 mm	70 mm	30	monoblok, INOX

Posuvné měřítko s hloubkoměrem a vnitřním měřením, aretace tlačítkem

Vernier Caliper with Thumb Lock and Depth Gauge

Suwmiarka analogowa z pomiarem głębokości i pomiarem wewnętrznym z przyciskiem blokującym

DIN
862

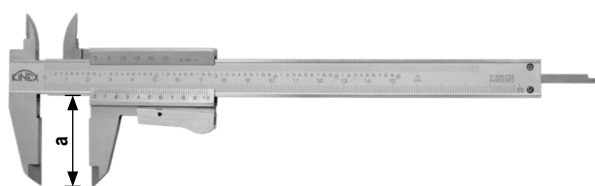

CODE			a [mm]	
6000-3	0,02 mm+inch	150 mm	40	monoblok, INOX
6000-4	0,05 mm+inch	150 mm	40	monoblok, INOX
6000-20	0,02 mm+inch	160 mm	40	monoblok, INOX
6000-21	0,05 mm+inch	160 mm	40	monoblok, INOX

Posuvné měřítko s hloubkoměrem a vnitřním měřením, paralelní vedení, aretace šroubkem, TOP QUALITY

Vernier Caliper with Locking Screw and Depth Gauge, parallax, TOP QUALITY

Suwmiarka analogowa z pomiarem głębokości i pomiarem wewnętrznym, pararelne prowadzenie, śruby aretujące - TOP QUALITY

DIN
862

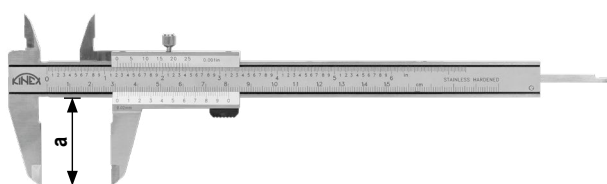

CODE			a [mm]	
6000-02-150	0,02 mm+inch	150 mm	40	monoblok
6000-02-200	0,02 mm+inch	200 mm	50	monoblok
6000-02-300	0,02 mm+inch	300 mm	60	monoblok

Posuvné měřítko PRO LEVÁKY s hloubkoměrem a vnitřním měřením, jemné stavění, paralelní vedení, aretace šroub., TOP QUALITY

Vernier Caliper FOR LEFT-HANDERS with Locking Screw and Depth Gauge, paralex line type, TOP QUALITY

Suwmiarka DLA LEWORĘCZNYCH analogowa z pomiarem głębokości i pomiarem wewnętrznym, pararelne prowadzenie, śruby aret. - TOP QUALITY

DIN
862

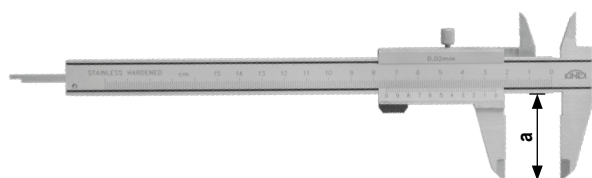

CODE			a [mm]	
6000-12-150	0,02 mm	150 mm	40	monoblok



Posuvná měřítka | Calipers | Suwmiarki

Posuvné měřítko s vnitřním měřením, jemné stavění
Vernier Caliper with Locking Screw and Depth Gauge, Fine Adjustment
Suwmiarka ze šrubą i suwakiem pomocniczym

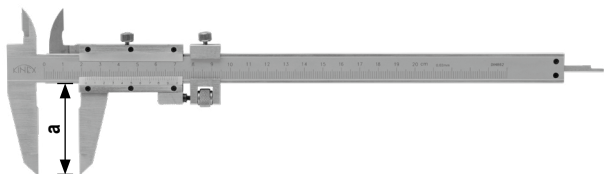

CODE			a [mm]	
6002	0,02 mm	200 mm	50	šroub. screw śruba non.
6003	0,02 mm	300 mm	55	šroub. screw śruba non.

Posuvné měřítko s vnitřním měřením a hloubkoměrem, jemné stavění
Vernier Caliper with Locking Screw and Depth Gauge, Fine Adjustment
Suwmiarka ze šrubą i suwakiem pomocniczym, precyzyjna regulacja

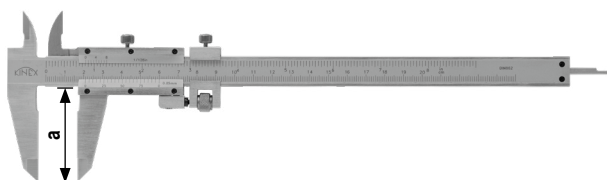

CODE			a [mm]	
6002-90-1	0,05 mm + 1/128 inch	200 mm	50	šroub. screw śruba non.
6003-90-1	0,05 mm + 1/128 inch	300 mm	55	šroub. screw śruba non.

Posuvné měřítko s číselníkovým úchylkoměrem ANTISHOCK (nárazuvzdorné provedení)
Dial Caliper and Depth Gauge ANTISHOCK
Suwmiarka z czujnikiem zegarowym ANTISHOCK (wstrząsoodporny projekt)



CODE			a [mm]
6013-02-150	0,02 mm	150 mm	40
6013-02-200	0,02 mm	200 mm	45
6013-02-300	0,02 mm	300 mm	55

Posuvné měřítko mosazné (nemagnetické)
Vernier Brass Caliper
Zacisk mosiężny (niemagnetyczny)

0,1



Hloubkoměr mosazný (nemagnetický)
Depth Brass Caliper
Miernik głębokości mosiądzu (niemagnetyczny)

0,1



CODE	
6029-02-100	0 - 100 mm



CODE	
2029-02-030	0 - 30 mm

Posuvná měřítka na rýsování | Marking Calipers | Suwmiarki do rysowania

Posuvné měřítka na rýsování - hrot slinutý karbid
 Marking Caliper - Cemented Carbide Tip
 Suwmiarka traserska z rysikiem, grot węglkowy

0,02

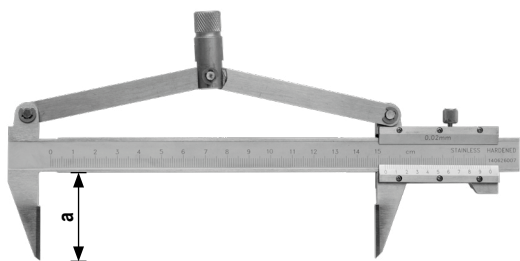

CODE		a [mm]
6005-10	150 mm	40
6005-15	200 mm	40
6005-20	250 mm	40
6005-25	300 mm	40

Posuvné měřítka rýsovací s výměnným hrotem, šroubovací nonius
 Marking Caliper with Replaceable Tip & Screw Vernier
 Suwmiarka traserska z rysikiem, grotom węglkowym, śrubą noniusza

0,1



CODE	hrot tip końcówka	
6005-50	29x2 mm	200/40 mm
6005-55	29x2 mm	400/40 mm
6006-2	náhr. hrot - tvrdokov repl. tip - carbide zapasowa końcówka utwardzana	

Přípravek na orýsování s mm stupnicí NEREZOVÁ OCEL
 Steel Marking Gauge STAINLESS STEEL
 Przyrząd kreskowy nastawny STAL NIERDZEWNA

INOX

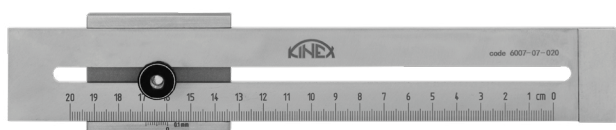

CODE	
6007-07-015	150 mm
6007-07-020	200 mm
6007-07-030	300 mm

Posuvné měřítka na rýsování paralelní typ T
 Steel Marking Gauge type T
 Suwmiarka traserska równoległa typu T

0,05

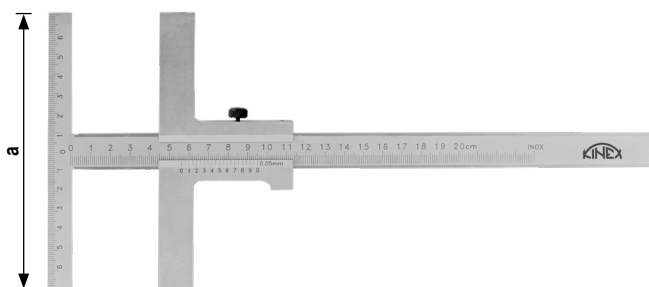

CODE		a [mm]
6007-02-160	160 mm	120
6007-02-200	200 mm	140
6007-02-250	250 mm	140
6007-02-300	300 mm	160
6007-02-400	400 mm	160
6007-02-500	500 mm	160



Posuvná měřítka | Calipers | Suwmiarki

Posuvné měřítko s jemným stavěním, šroubovací nonius
 Vernier Caliper with Locking Screw and Fine Adjustment, vernier screw
 Suwmiarka jednostronna z suwakiem pomocniczym, śruba noniusza

NEW
LINE

ČSN
EN ISO
13385-1

ČSN
25 1231

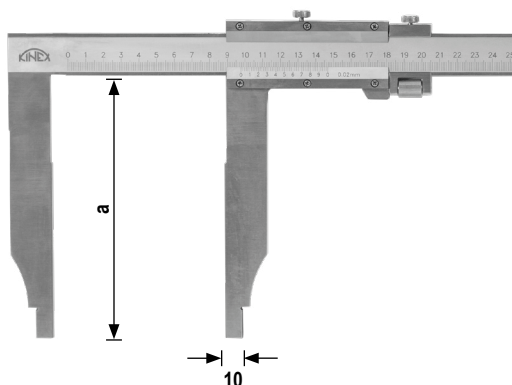

Od 500 mm dodáváno včetně protokolu o přeměření.
 From 500 mm supplied with the Measuring Protocol.
 Od 500 mm dostarczamy wraz z protokołem o przemierzeniu.

CODE			a [mm]
6015-62-100	0,02 mm	400 mm	100
6015-02-100	0,02 mm	500 mm	100
6015-02-125	0,02 mm	500 mm	125
6015-02-150	0,02 mm	500 mm	150
6015-02-200	0,02 mm	500 mm	200
6015-12-100	0,02 mm	600 mm	100
6015-12-125	0,02 mm	600 mm	125
6015-12-150	0,02 mm	600 mm	150
6015-12-200	0,02 mm	600 mm	200
6015-22-150	0,02 mm	800 mm	150
6015-22-200	0,02 mm	800 mm	200
6015-32-125	0,02 mm	1000 mm	125
6015-32-150	0,02 mm	1000 mm	150
6015-32-200	0,02 mm	1000 mm	200
6015-42-150	0,02 mm	1500 mm	150
6015-42-200	0,02 mm	1500 mm	200
6015-52-200	0,05 mm	2000 mm	200
6015-52-300	0,05 mm	2000 mm	300
6015-72-200	0,05 mm	2500 mm	200
6015-72-300	0,05 mm	2500 mm	300

Posuvné měřítko s jemným stavěním a stupnicí mm + inch
 Vernier Caliper with Locking Screw and Fine Adjustment, mm + inch
 Suwmiarka jednostronna z suwakiem pomocniczym i skalą mm + inch

ČSN
EN ISO
13385-1

ČSN
25 1231

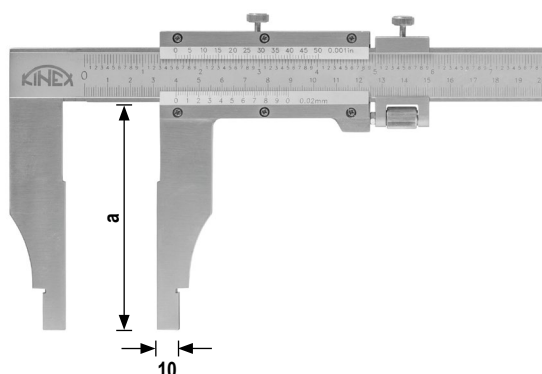

CODE			a [mm]
6015-08-040	0,05 mm + 1/128inch	400 mm	100
6015-08-050	0,05 mm + 1/128inch	500 mm	125
6015-08-060	0,05 mm + 1/128inch	600 mm	125
6015-08-100	0,05 mm + 1/128inch	1000 mm	125
6015-08-150	0,05 mm + 1/128inch	1500 mm	125

Posuvná měřítka | Calipers | Suwmiarki

Posuvné měřítko oboustranné s jemným stavěním, šroubovací nonius
 Vernier Caliper with Locking Screw and Fine Adjustment
 Suwmiarka z suwakiem pomocniczym, śruba noniusza

ČSN
 EN ISO
 13385-1

ČSN
 25 1234

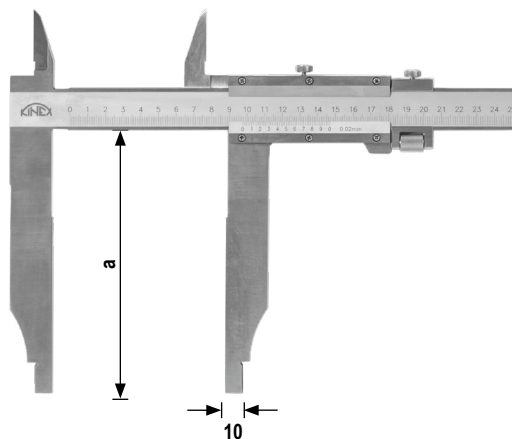

CODE			a [mm]
6022-62-100	0,02 mm	400 mm	150
6022-02-150	0,02 mm	500 mm	150
6022-12-150	0,02 mm	600 mm	150
6022-22-150	0,02 mm	800 mm	150
6022-32-150	0,02 mm	1000 mm	150
6022-42-200	0,02 mm	1500 mm	200
6022-52-150	0,02 mm	2000 mm	150
6022-52-200	0,05 mm	2000 mm	200

Od 500 mm dodáváno včetně protokolu o přeměření.
 From 500 mm supplied with the Measuring Protocol.
 Od 500 mm dostarczamy wraz z protokołem o przemierzeniu.



Posuvná měřítka | Calipers | Suwmiarki

Digitální posuvné měřítka KINEX Labo ICONIC do vlhkého prostředí
 Digital Caliper KINEX ICONIC Labo - moisture resistant IP 67, TOP QUALITY, PC
 Suwmiarka elektroniczna KINEX Labo ICONIC do środowiska wilgotnego

INOX

0,01



Dodáváno včetně protokolu o přeměření,
 Supplied with the Measuring Protocol.
 Dostarczamy wraz z protokołem o przemierzaniu.

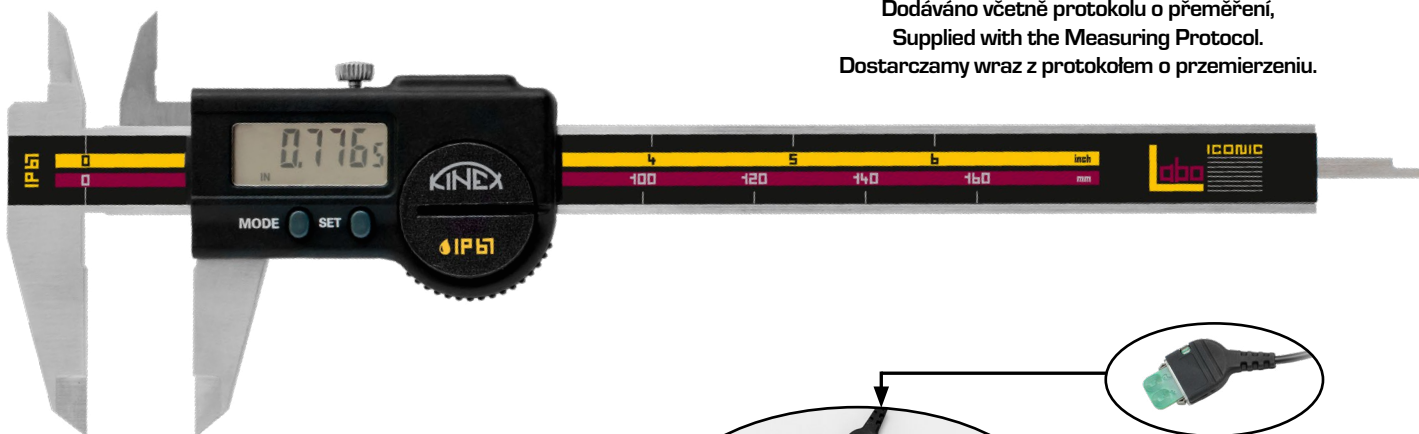

- » Ochrana **IP67** i při připojení datového kabelu **KINEX ICL**
- » Systém **IIS** – Inteligentní Induktivní Snímač s korekcí chyb
- » Automatické zapnutí **pohybem** DIGI jednotky
- » Automatické vypnutí po **20 minutách** nečinnosti
- » Paměť poslední měřené hodnoty
- » Maximální rychlost pohybu **2,5m/s**
- » **Nerezové** broušené tělo odolné proti agresivnímu solnému prostředí

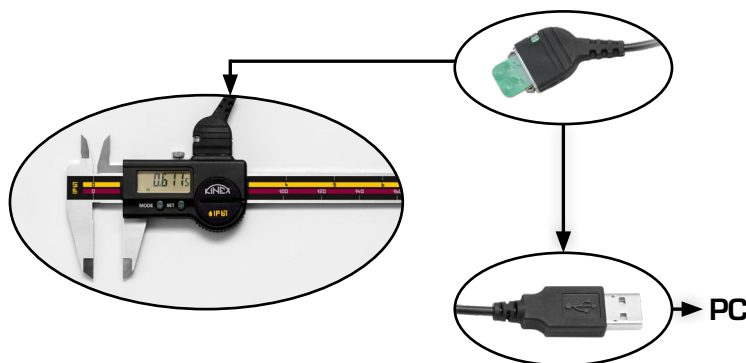

- » **Water protected IP67** for work with coolants and lubricants, **even connected**
- » **Automatic wake-up** by moving the electronic on his frame. (system IIS)
- » Position memorized in sleeping mode (system IIS), absolute system
- » **Sleeping mode** after 20 minutes of no use. (system IIS)
- » Maximum speed of displacement : 2.5 m/sec

- » Stopień ochrony **IP67** nawet po podłączeniu kabla do transmisji danych **KINEX ICL**
- » System **IIS** – Inteligentny czujnik indukcyjny korekcji błędów
- » Automatycznie włączenie **poprzez poruszenie jednostki**
- » Automatycznie odłączenie po **20 minutach** bezczynności
- » Pamięć ostatnich wartości mierzonych
- » Maksymalna prędkość **2,5m/s**
- » Ciało polerowana **stal nierdzewna** odporna na agresywne środowisko soli

CODE	L	a	b	c	d
6040-27-150	0 - 150 mm	234,5	40,0	11,0	26,0 16x3,5
6040-27-200	0 - 200 mm	290,5	50,0	14,0	26,0 16x3,5
6040-27-300	0 - 300 mm	388,0	64,0	14,0	26,0 16x4,0

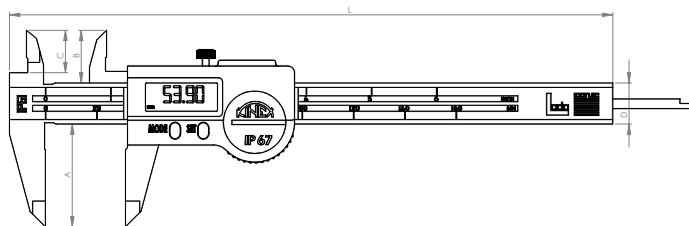

Interface pro připojení k PC na posuvná měřítka a digitální mikrometry KINEX Labo ICONIC

PC Interface for KINEX ICONIC Labo

Interface do połączenia z komputerem KINEX Labo ICONIC



CODE

6040-27-900

Posuvná měřítka | Calipers | Suwmiarki

Digitální posuvné měřítko KINEX ABSOLUTE ZERO
 Digital Caliper KINEX ABSOLUTE ZERO
 Suwmiarka elektroniczna KINEX ABSOLUTE ZERO



0,01

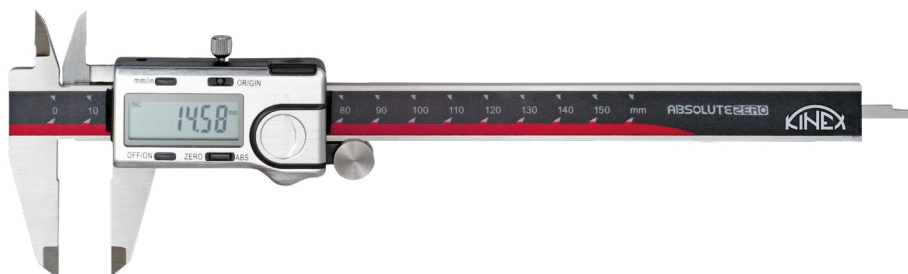

automatické vypínání při nečinnosti
 automatic sleep when idle
 automatycznie wyłączenie w stanie bezczynności

Dodáváno včetně protokolu o přeměření.
 Supplied with the Measuring Protocol.
 Dostarczamy wraz z protokołem o przemierzeniu.

CODE		L [mm]	a [mm]	b [mm]	c [mm]	d [mm]
6040-05-100	0 - 100 mm	184,5	40	11	16	16x3,5
6040-05-150	0 - 150 mm	234,5	40	11	16	16x3,5
6040-05-151 *	0 - 150 mm	234,5	40	11	16	16x3,5
6040-05-200	0 - 200 mm	290,5	50	14	19	16x3,5
6040-05-300	0 - 300 mm	388,0	64	14	19	16x4,0

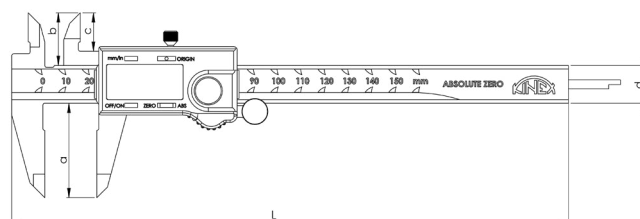

* kulatý hloubkoměr | round depth | okrągłe głębia \varnothing 1,5mm

Interface pro připojení k PC na posuvná měřítka a digitální mikrometry KINEX ABSOLUTE ZERO
 PC Interface for KINEX ABSOLUTE ZERO
 Interface do połączenia z komputerem KINEX ABSOLUTE ZERO



CODE	
6040-05-900	interface
6040-05-901	nožní spínač footswitch przełącznik nożny
6040-05-902	kabel

Digitální posuvné měřítko KINEX ABZ DESIGN
 Digital Caliper KINEX ABZ DESIGN
 Suwmiarka elektroniczna KINEX ABZ DESIGN



0,01



automatické vypínání při nečinnosti
 automatic sleep when idle
 automatycznie wyłączenie w stanie bezczynności

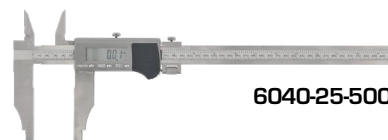

6040-25-500

Dodáváno včetně protokolu o přeměření.
 Supplied with the Measuring Protocol.
 Dostarczamy wraz z protokołem o przemierzeniu.

CODE		a [mm]	b [mm]	c [mm]	d [mm]
6040-25-150	0,01 mm 0 - 150 mm	40	22,5	16,8	16 IP67
6040-25-200	0,01 mm 0 - 200 mm	50	25,5	19,8	16 IP67
6040-25-300	0,01 mm 0 - 300 mm	60	27	21	17 IP67
6040-25-500	0,01 mm 0 - 500 mm	100	45	39	24 IP66

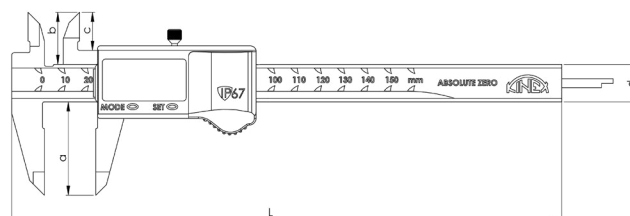



Posuvná měřítka | Calipers | Suwmiarki

Posuvné měřítko digitální - tvrdokov
Digital Caliper - carbide
Suwmiarka elektroniczna - węglik



0,01

DIN
862



tvrdokov | carbide | węglik

CODE			a [mm]
6041-25-150	0,01 mm	0 - 150 mm	40 mm

automatické vypínání při nečinnosti
automatic sleep when idle
automatycznie wyłączenie w stanie bezczynności

Posuvné měřítko digitální
Digital Caliper
Suwmiarka elektroniczna

0,01

DIN
862

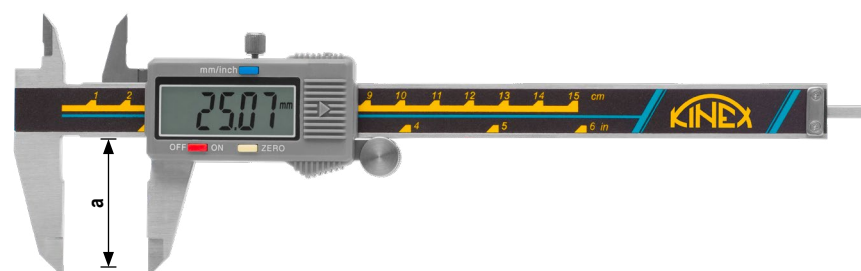

CODE			a [mm]
6040-2	0,01 mm	0 - 150 mm	40 mm
6041-2	0,01 mm	0 - 200 mm	50 mm
6042-2	0,01 mm	0 - 300 mm	60 mm

Posuvné měřítko digitální
Digital Caliper
Suwmiarka elektroniczna

0,01

DIN
862



CODE			a [mm]
6040-02-150	0,01 mm	0 - 150 mm	40 mm
6040-02-200	0,01 mm	0 - 200 mm	50 mm
6040-02-300	0,01 mm	0 - 300 mm	60 mm

Posuvné měřítko digitální - pro leváky
Digital Caliper for left-handers
Suwmiarka elektroniczna - dla leworęcznych

0,01

DIN
862



CODE			a [mm]
6040-14-150	0,01 mm	150 mm	40
6040-14-200	0,01 mm	200 mm	50
6040-14-300	0,01 mm	300 mm	60

Posuvná měřítka | Calipers | Suwmiarki

Posuvné měřítka digitální solární
Digital Solar Caliper
Suwmiarka elektroniczna, fotowoltaiczna

0,01

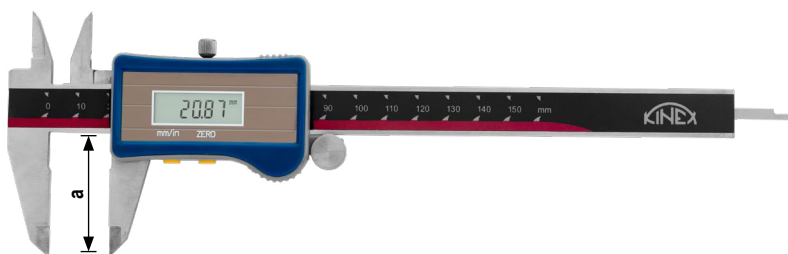

CODE			a [mm]
6040-15-150	0,01 mm	150 mm	40
6040-15-200	0,01 mm	200 mm	40
6040-15-300	0,01 mm	300 mm	40

Posuvné měřítka digitální - bez horních nožů
Digital Caliper - without upper jaws
Suwmiarka elektroniczna - bez górnych noży

0,01

DIN
862

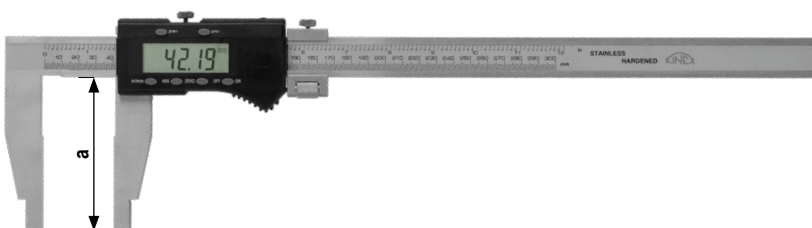

CODE			a [mm]
6042-20	0,01 mm	300	90 mm

Posuvné měřítka digitální nožové
Digital Blade Caliper
Suwmiarka elektroniczna specjalna

0,01

DIN
862



CODE			a [mm]	b [mm]
6040-75-200	0,01 mm	200 mm	70	17
6040-75-210	0,01 mm	200 mm	100	20

Nástavec pro digitální posuvná měřítka do 300mm
Extension for Digital Calipers up to 300mm
Przedłużacz elektronicznych suwmiarek do 300 mm

NEW

CODE

6040-00-075

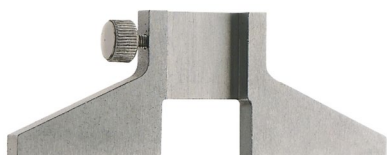



Posuvná měřítka | Calipers | Suwmiarki

Posuvné měřítko digit. - bez horních nožů
 Digital Caliper with Locking Screw & Fine Adjustment
 Suwmiarka elektr. - bez górnych nožů

0,01

DIN
862

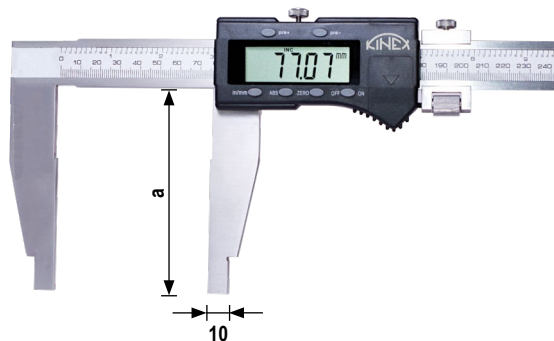

Posuvné měřítko digit. - s horními noži
 Digital Caliper with Locking Screw & Fine Adjustment
 Suwmiarka elektr. - z górnyimi nożami

0,01

DIN
862

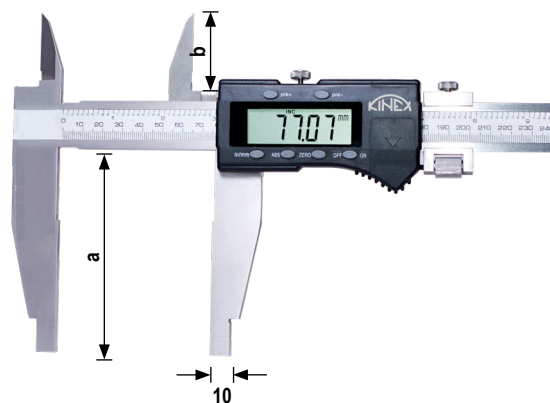

CODE			a [mm]	
6043-65-100	0,01 mm	400 mm	100	
6043-05-100	0,01 mm	500 mm	100	
6043-05-125	0,01 mm	500 mm	125	
6043-05-150	0,01 mm	500 mm	150	
6043-05-200	0,01 mm	500 mm	200	
6043-15-100	0,01 mm	600 mm	100	
6043-15-125	0,01 mm	600 mm	125	
6043-15-150	0,01 mm	600 mm	150	
6043-15-200	0,01 mm	600 mm	200	
6043-15-300	0,01 mm	600 mm	300	
6043-25-125	0,01 mm	800 mm	125	
6043-25-150	0,01 mm	800 mm	150	
6043-35-125	0,01 mm	1000 mm	125	
6043-35-150	0,01 mm	1000 mm	150	
6043-45-150	0,01 mm	1500 mm	150	
6043-45-200	0,01 mm	1500 mm	200	
6043-45-300	0,01 mm	1500 mm	300	
6043-55-150		0,01 mm	2000 mm	150
6043-75-200		0,01 mm	2500 mm	200
6043-75-300		0,01 mm	2500 mm	300

CODE			a [mm]	b [mm]	
6044-65-150	0,01 mm	400 mm	150	38	
6044-05-100	0,01 mm	500 mm	100	38	
6044-05-125	0,01 mm	500 mm	125	51,5	
6044-05-150	0,01 mm	500 mm	150	51,5	
6044-05-200	0,01 mm	500 mm	200	51,5	
6044-15-100	0,01 mm	600 mm	100	38	
6044-15-125	0,01 mm	600 mm	125	51,5	
6044-15-150	0,01 mm	600 mm	150	51,5	
6044-15-200	0,01 mm	600 mm	200	51,5	
6044-25-125	0,01 mm	800 mm	125	51,5	
6044-25-150	0,01 mm	800 mm	150	51,5	
6044-35-125	0,01 mm	1000 mm	125	51,5	
6044-35-150	0,01 mm	1000 mm	150	51,5	
6044-45-150	0,01 mm	1500 mm	150	61	
6044-55-150		0,01 mm	2000 mm	150	61
6044-55-200		0,01 mm	2000 mm	200	61

Od 500mm dodáváno včetně protokolu o přeměření
 From 500 mm supplied with the Measuring Protocol
 Od 500 mm dostarczamy wraz z protokołem o przemierzeniu.

Posuvná měřítka | Calipers | Suwmiarki

Posuvné měřítka digitální na zápichy vnitřní ABZ DESIGN
 Digital Groove Inside Caliper - ABZ DESIGN
 Suwmiarka elektroniczna do kanałków wewnętrznych ABZ DESIGN

0,01

DIN
862

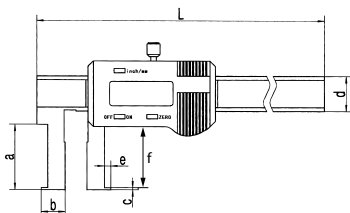

CODE	L [mm]	a [mm]	b [mm]	c [mm]	d [mm]	e [mm]	f [mm]
6040-55-150	22 - 150 mm	250	30	11	1,0	16	5
6040-55-200	25 - 200 mm	310	40	12	1,0	16	5
6040-55-300	30 - 300 mm	410	50	15	1,5	17	5

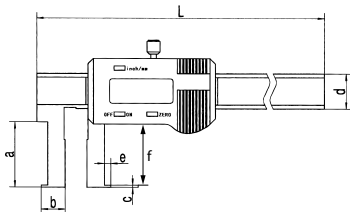

do malých otvorů | do malých otvorov | w małych otworów



CODE	L [mm]	a [mm]	b [mm]	c [mm]	d [mm]	e [mm]	f [mm]
6040-55-151	14 - 150 mm	236	30	12	1,0	16	5

Posuvné měřítka digitální na zápichy vnější ABZ DESIGN
 Digital Groove Outside Caliper - ABZ DESIGN
 Suwmiarka elektroniczna do kanałków zewnętrznych ABZ DESIGN

0,01

DIN
862

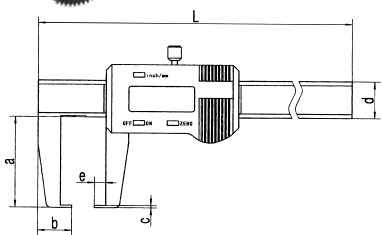
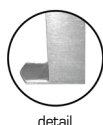
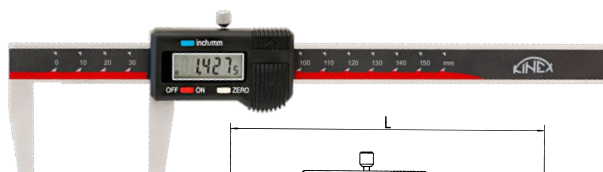

CODE	L [mm]	a [mm]	b [mm]	c [mm]	d [mm]	e [mm]	f [mm]
6040-65-150	0 - 150 mm	250,0	40,0	15,0	1,0	16,0	5
6040-65-200	0 - 200 mm	310,0	50,0	19,0	1,0	16,0	7
6040-65-300	0 - 300 mm	400,0	60,0	21,0	1,5	17,0	8

Posuvné měřítka digitální na brzdové bubny
 Digital Disc Brake Caliper
 Suwmiarka elektroniczna do tarcz hamulcowych



0,01

Posuvné měřítka digitální na ozubená kola
 Digital Gear Tooth Caliper
 Suwmiarka elektroniczna do kół zębatych



0,01

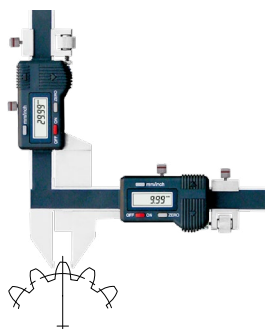

CODE	L [mm]
6041-15-025	M1 - 25
6041-15-050	M5 - 50



6041-35-060

CODE	L [mm]
6041-35-060	0 - 60 mm
6041-35-100	0 - 100 mm



6041-35-100



Posuvná měřítka | Calipers | Suwmiarki

Posuvné měřítka digitální na měření síly trubek
Digital Caliper for Tube Thickness
Suwmiarka elektroniczna do pomiaru grubości rurek

0,01 **DIN 862**

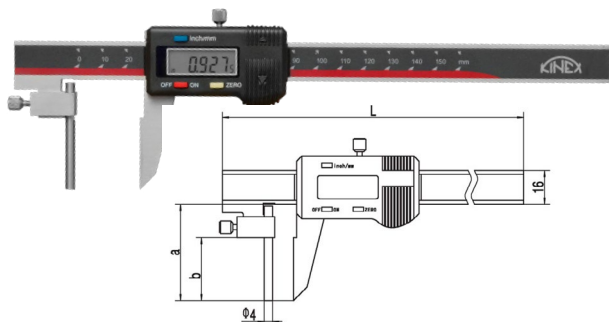

CODE		L [mm]	a [mm]	b [mm]
6040-85-150	0 - 150 mm	250	46	30
6040-85-200	0 - 200 mm	300	56	40
6040-85-300	0 - 300 mm	400	66	50

Posuvné měřítka rýsovací s výměnným hrotem
Marking Caliper with Replaceable Tip
Suwmiarka traserska z rysikiem, grotom węglkowym

NEW 0,01

Přípravek na orýsování - digitální
Digital Marking Gauge
Przyrząd kreskowy nastawny elektroniczny

NEW 0,01



CODE	
6041-55-150	0 - 150 mm

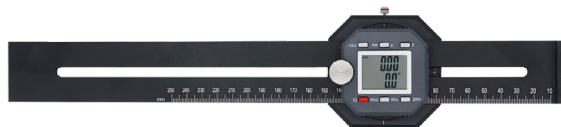

CODE	
6041-45-200	0 - 200 mm

Posuvné měřítka na měření průměru lan
Digital Rope Caliper
Przyrząd kreskowy nastawny elektroniczny

NEW 0,01

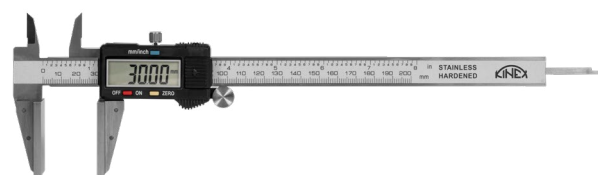

CODE	
6041-75-200	0 - 200 mm

Digitální posuv ABZ DESIGN
Digital Scale Unit - ABZ DESIGN
Liniał elektroniczny ABZ DESIGN

DIN 862



VERTIKÁLNÍ | VERTICAL | PIONOWY

CODE		L [mm]
6040-45-150	0,01 mm	150 mm
6040-45-200	0,01 mm	200 mm
6040-45-300	0,01 mm	300 mm
6040-45-400	0,01 mm	400 mm
6040-45-500	0,01 mm	500 mm
6040-45-600	0,01 mm	600 mm



HORIZONTÁLNÍ | HORIZONTAL | POZIOMY

CODE		L [mm]
6040-35-150	0,01 mm	150 mm
6040-35-200	0,01 mm	200 mm
6040-35-300	0,01 mm	300 mm
6040-35-400	0,01 mm	400 mm
6040-35-500	0,01 mm	500 mm
6040-35-600	0,01 mm	600 mm

Posuvná měřítka | Calipers | Suwmiarki

Náhradní baterie
Spare battery
Bateria zapasowa



6040-1

6040-01

6040-05

CODE

6040-1	LR44 1,55V
6040-01	CR2032 3V
6040-05	CR1632 3V, Lithium

Posuvné plastové měřítka - HOBBY
Digital Caliper Plastic - HOBBY
Suwmiarka analogowa z tworzywa sztucznego - HOBBY

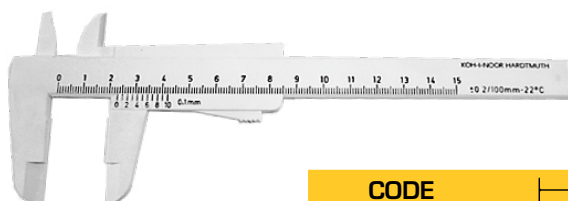

CODE

6050 150/40 mm

Digitální posuvné měřítka plastové
Digital Caliper Plastic
Suwmiarka elektroniczna z tworzywa sztucznego



CODE

6050-02-150 150/40 mm

Lesnické průměrky | Forester Calipers | Suwmiarki leśnicze

Lesnická průměrka s permanentní brzdou a stupnicí s laserovým popisem, Red&Black LINE
Forester Caliper Red&Black LINE
Suwmiarka leśnicza z blokadą z opisem laserowym, Red&Black LINE

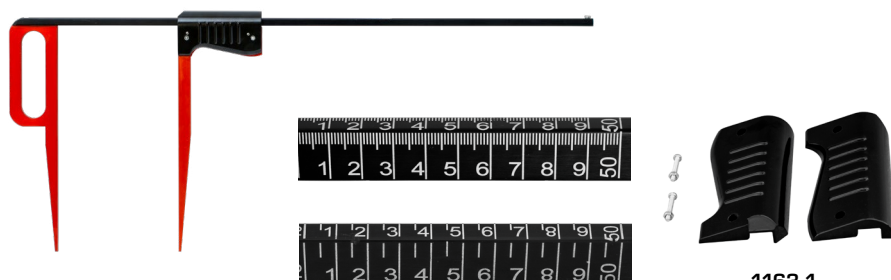

1163-1

CODE

CODE	Scale	Length
1162-08-050	1 mm	500/255 mm
1162-08-080	1 mm	800/410 mm
1162-08-100	1 mm	1000/410 mm
1162-05-050	5 mm	500/255 mm
1162-05-080	5 mm	800/410 mm
1162-05-100	5 mm	1000/410 mm
1163-1	náhradní madlo spare handle uchwyt wymienny	pár pair para



Mikrometry | Micrometres | Mikrometry

Mikrometr třmenový
Outside Micrometer
Mikrometr zewnętrzny

0,01

ČSN
25 1420

DIN
863

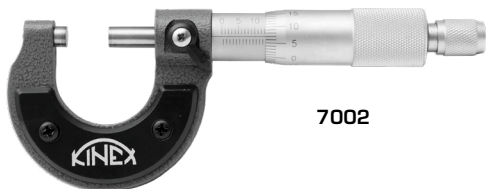

7002



7004 - 7008

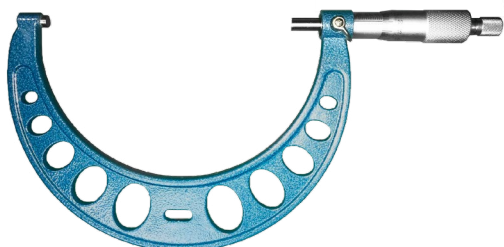

7011 - 7025



7025-0
7026-0

CODE		L
7002	0,01 mm	0 - 25 mm
7004	0,01 mm	25 - 50 mm
7006	0,01 mm	50 - 75 mm
7008	0,01 mm	75 - 100 mm
7011	0,01 mm	100 - 125 mm
7013	0,01 mm	125 - 150 mm
7015	0,01 mm	150 - 175 mm
7017	0,01 mm	175 - 200 mm
7019	0,01 mm	200 - 225 mm
7021	0,01 mm	225 - 250 mm
7023	0,01 mm	250 - 275 mm
7025	0,01 mm	275 - 300 mm
7025-0	0,01 mm	100 - 200 mm
7026-0	0,01 mm	200 - 300 mm
7026	0,01 mm	300 - 400 mm
7027	0,01 mm	400 - 500 mm
7027-1	0,01 mm	500 - 600 mm
7027-2	0,01 mm	600 - 700 mm
7027-3	0,01 mm	700 - 800 mm
7027-4	0,01 mm	800 - 900 mm
7027-5	0,01 mm	900 - 1000 mm

NEW
LINE



7026 - 7027-5

Dodáváno včetně nastavovacího kalibru.
Supplied with Setting Gauge.
Dostarczamy wraz z krążkiem ustawiającym.

Mikrometry | Micrometres | Mikrometry

Mikrometr třmenový - PROFESSIONAL
 Outside Micrometer - PROFESSIONAL
 Mikrometr zewnętrzny - PROFESSIONAL

DIN
863

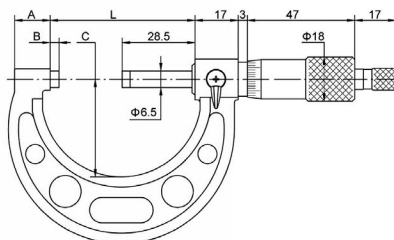

CODE		
7002-02-025	0,01 mm	0 - 25 mm

Nastavovací kalibr mikrometru
 Setting Gauge for Micrometers
 Wzorec nastawczy do mikrometru

DIN
863



CODE	
7002-00-025	25 mm
7002-00-050	50 mm
7002-00-075	75 mm
7002-00-100	100 mm

Mikrometr třmenový na závit
 Screw Thread Micrometer
 Mikrometr do gwintu

DIN
863



CODE		
7028-31	0,01 mm	0 - 25 mm
7028-32	0,01 mm	25 - 50 mm
7028-33	0,01 mm	50 - 75 mm
7028-34	0,01 mm	75 - 100 mm
7028-35	0,01 mm	100 - 125 mm
7028-36	0,01 mm	125 - 150 mm
7028-37	0,01 mm	150 - 175 mm
7028-38	0,01 mm	175 - 200 mm

Nástavce na závit - pár
 V-shaped and Knife Anvils - pair
 Końcówki mikrometru do pomiaru gwintu - para



CODE		stoupání stúpanie rosnać
7028-41	60°	0,40 - 0,50 mm
7028-42	60°	0,60 - 0,90 mm
7028-43	60°	1,00 - 1,75 mm
7028-44	60°	2,00 - 3,00 mm
7028-45	60°	3,50 - 5,00 mm
7028-46	60°	5,50 - 7,00 mm



Mikrometry | Micrometres | Mikrometry

Mikrometr KINEX Labo ICONIC - třmenový, digitální
 Digital Outside Micrometer KINEX ICONIC Labo
 Mikrometr KINEX Labo ICONIC - zewnętrzny, elektroniczny

NEW LINE

10mm

INOX

0,001



IP 67

DIN 863



Dodáváno včetně protokolu o přeměření
 Supplied with the Measuring Protocol
 Dostarczamy wraz z protokołem o przemierzeniu



BLUETOOTH SIMPLE PROFILE

Integrovaný bezdrátový přenos dat přes Bluetooth pro základní použití se k připojení jako zařízení standardu HID, není potřeba žádný další software

Integrated wireless data transfer via Bluetooth for basic use, connect as HID standard device, no additional software is needed.

Integrowany bezprzewodowy transfer danych poprzez Bluetooth. Do codziennego użytkowania. Podłącz jako urządzenie standardowe HID, żadne dodatkowe oprogramowanie nie jest potrzebne.

- » Ochrana **IP67**
- » Systém **IIS** – Inteligentní Induktivní Snímač s korekcí chyb
- » Automatické zapnutí **pohybem** DIGI jednotky
- » Automatické vypnutí po **20 minutách** nečinnosti
- » Paměť poslední měřené hodnoty
- » Maximální rychlost pohybu **2,5m/s**
- » **Nerezové** broušené tělo odolné proti agresivnímu solnému prostředí
- » **Water protected** for heavy-duty work with coolants and lubricants, protection rating **IP67** according to IEC 60529
- » **Automatic wake-up** by moving the measuring spindle (system S.I.S)
- » Sleeping mode after 20 min. of no use (system S.I.S)
- » **Position memorized in sleeping mode** (system S.I.S), absolute system
- » Quick displacement of the measuring spindle **12 mm / rotation**
- » **Adjustable measuring force** 5N / 10N (version 7030-27-030)
- » Repeatability and reproducibility never reached before
- » Measuring range **0-102 mm covered with 3 instruments only**
- » Stopień ochrony **IP67**
- » System **IIS** – Inteligentny czujnik indukcyjny korekcji błędów
- » Automatyczne włączenie **poprzez poruszenie jednostki**
- » Automatycznie odłączenie po **20 minutach** bezczynności
- » Pamięć ostatnich wartości mierzonych
- » Maksymalna prędkość **2,5m/s**
- » Ciało polerowana **stal nierdzewna** odporna na agresywne środowisko sol

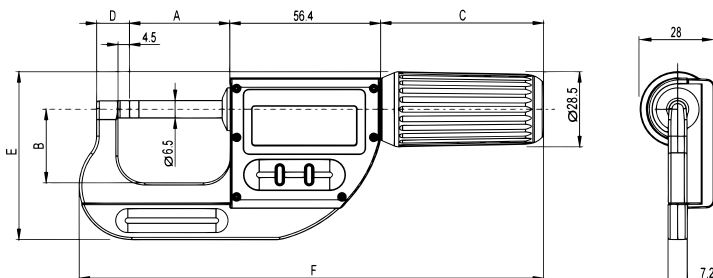

CODE		A [mm]	B [mm]	C [mm]	D [mm]	E [mm]	F [mm]	G [mm]
7031-97-030	0 - 30 mm	37,3	27,5	62,0	12,5	63,0	174	7,2
7031-97-066	30 - 66 mm	73,3	43,0	74,0	13,5	86,0	230	9,0
7031-97-102	66 - 102 mm	109,3	60,0	74,0	14,5	106,0	269	9,0

Mikrometry | Micrometres | Mikrometry

Mikrometr KINEX ABSOLUTE ZERO - třmenový, digitální
 Digital Outside Micrometer KINEX ABSOLUTE ZERO
 Mikrometr KINEX ABSOLUTE ZERO - zewnętrzny, elektroniczny

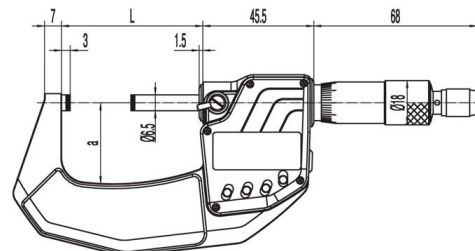

Dodáváno včetně nastavovacího kalibru a protokolu o přeměření.
 Supplied with Setting Gauge and Protocol of remeasurement.
 Dostarczamy wraz z krążkiem ustawiającym i protokołem o przemierzeniu.

CODE		L [mm]	a [mm]
7030-05-025	0 - 25 mm	33,0	25,0
7030-05-050	25 - 50 mm	58,0	32,5
7030-05-075	50 - 75 mm	83,0	47,5
7030-05-100	75 - 100 mm	108,0	60,0

Interface pro připojení k PC na posuvná měřítka a digitální mikrometry KINEX ABSOLUTE ZERO
 PC Interface for Digital Calipers, Micrometers, Indicators KINEX ABSOLUTE ZERO
 Interface do połączenia z komputerem KINEX ABSOLUTE ZERO



CODE	
6040-05-9001	interface
6040-05-901	nožní spínač footswitch przełącznik nożny
6040-05-903	kabel

Mikrometr třmenový digitální
 Digital Outside Micrometer
 Mikrometr zewnętrzny elektroniczny

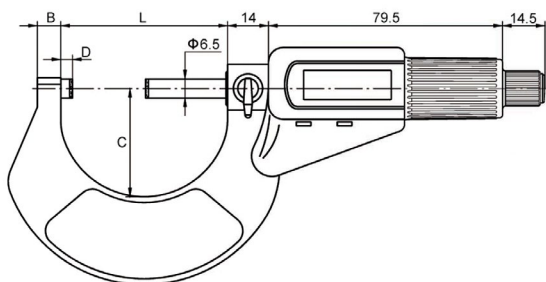
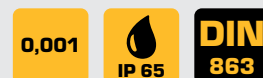

CODE	B [mm]	C [mm]	D [mm]	L [mm]	
7031-02-025	6	27,5	3	32	0 - 25 mm
7031-02-050	8	37,0	3	57	25 - 50 mm
7031-02-075	8	50,0	3	82	50 - 75 mm
7031-02-100	10	61,0	3	107	75 - 100 mm
7031-02-125	16	72,0	3	132	100 - 125 mm
7031-02-150	18	85,0	3	158	125 - 150 mm
7031-02-175	20	105,0	3	185	150 - 175 mm
7031-02-200	25	122,0	3	215	175 - 200 mm

Dodáváno včetně nastavovacího kalibru.
 Supplied with Setting Gauge.
 Dostarczamy wraz z krążkiem ustawiającym.



Mikrometry | Micrometres | Mikrometry

Mikrometrický tloušťkoměr digitální
Digital Thickness Gauge
Grubościomierz elektroniczny

0,01

DIN
863



CODE		d [mm]	
7040-1	0,01 mm	9	0 - 25 mm

Mikrometrický tloušťkoměr digitální ABZ
Digital Thickness Gauge ABZ
Grubościomierz elektroniczny ABZ

0,01

DIN
863



CODE		d [mm]	
7040-05-010	0,01 mm	9	0 - 10/30 mm
7040-15-010	0,01 mm	9	0 - 10/120 mm

Mikrometr na trubky
Tube Micrometer
Mikrometer do rur

0,01

DIN
863



CODE		
7041	0,01 mm	0-25 mm

Mikrometr na trubky digitální
Digital Tube Micrometer
Mikrometer elektroniczny do rur



0,001

DIN
863



CODE	B [mm]	C [mm]	D [mm]	L [mm]		
7041-02-025	6,0	25,0	3,0	34,5	0,001 mm	0 - 25 mm
7041-02-050	8,0	32,0	3,0	59,5	0,001 mm	25 - 50 mm

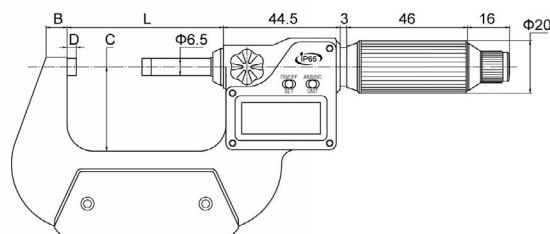

Mikrometry | Micrometres | Mikrometry

Mikrometr na drát
Wire Micrometer
Mikrometer do drutu

0,01

ČSN
25 1456



CODE



7043

0 - 10 mm

Mikrometr třmenový na ozubená kola
Disc Micrometer
Mikrometr do kól zębatých

0,01

ČSN
25 1456



CODE

d [mm]



7051

20

0 - 25 mm

7052

20

25 - 50 mm

7053

20

50 - 75 mm

7054

20

75 - 100 mm

7055

30

100 - 125 mm

7056

30

125 - 150 mm

7057

30

150 - 175 mm

7058

30

175 - 200 mm

Mikrometr třmenový na ozubená kola - digitální NEW DESIGN
Digital Disc Micrometer - NEW DESIGN
Mikrometr do kól zębatých - elektroniczny NEW DESIGN

0,001

DIN
863



CODE

d [mm]



7070-02-025

20

0 - 25 mm

7070-02-050

20

25 - 50 mm

7070-02-075

20

50 - 75 mm

7070-02-100

20

75 - 100 mm

7070-02-125

30

100 - 125 mm

7070-02-150

30

125 - 150 mm

7070-02-175

30

150 - 175 mm

7070-02-200

30

175 - 200 mm



Mikrometry | Micrometres | Mikrometry

Mikrometr na zápichy
Blade Micrometer
Mikrometr do kanáľov zvončtrzných

0,01 **DIN 863**

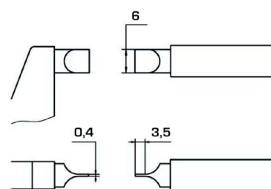
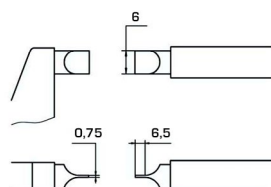

CODE	Range
7075-02-025	0 - 25 mm
7075-02-050	25 - 50 mm
7075-02-075	50 - 75 mm
7075-02-100	75 - 100 mm
7075-02-125	100 - 125 mm
7075-02-150	125 - 150 mm
7075-02-175	150 - 175 mm

CODE	Range
7076-02-025	0 - 25 mm

Mikrometr na zápichy - digitálny, rychloposuv
Blade Micrometer 0,4x6mm
Mikrometr do kanáľov zvončtrzných - elektronický, rýchly

2mm 0,001 **DIN 863**

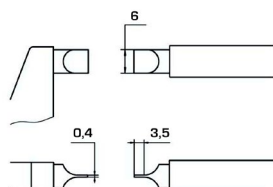
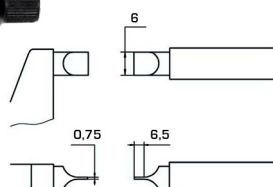

CODE	Range
7075-05-025	0 - 25 mm
7075-05-050	25 - 50 mm
7075-05-075	25 - 75 mm
7075-05-100	75 - 100 mm
7075-05-125	100 - 125 mm
7075-05-150	125 - 150 mm
7075-05-175	150 - 175 mm

CODE	Range
7076-05-025	0 - 25 mm

Mikrometr digitálny s hroty 30°
Digital Blade Micrometer
Mikrometr elektronický z konččvkami 30°

0,001 **DIN 863**



CODE	Range
7077-05-025	0 - 25 mm

Mikrometry | Micrometres | Mikrometry

Mikrometr dvoudotekový dutinový (dutinoměr)
Internal Jaw Micrometer
Mikrometr wewnętrzny

0,01

DIN
863

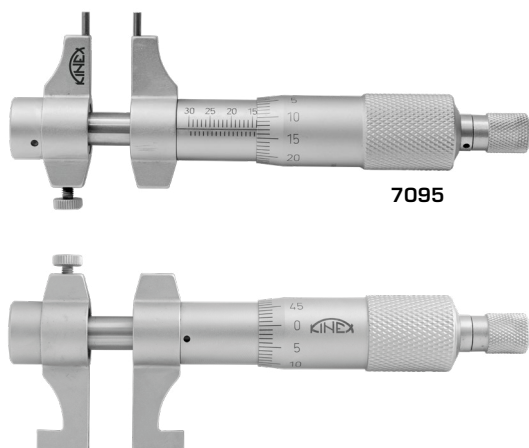

7095

CODE		0
7095	5 - 30 mm	5mm
7096	25 - 50 mm	25mm
7097	50 - 75 mm	-
7098	75 - 100 mm	-
7098-1	100 - 125 mm	-
7098-2	125 - 150 mm	-
7098-3	150 - 175 mm	-
7098-4	175 - 200 mm	-
7098-5	200 - 225 mm	-
7098-6	225 - 250 mm	-
7098-7	250 - 275 mm	-
7098-8	275 - 300 mm	-

Mikrometr dutinový dvoudotekový (dutinoměr) - digitální
Digital Internal Jaw Micrometer
Mikrometr wewnętrzny - elektroniczny

0,001

DIN
863



7100-02-030

CODE		0
7100-02-030	5 - 30 mm	5mm
7100-02-050	25 - 50 mm	25mm
7100-02-075	50 - 75 mm	-
7100-02-100	75 - 100 mm	-

DALŠÍ ROZMĚRY NA ZAKÁZKU
OTHER SIZES ON REQUEST
INNE WYMIARY NA ZAMÓWIENIE

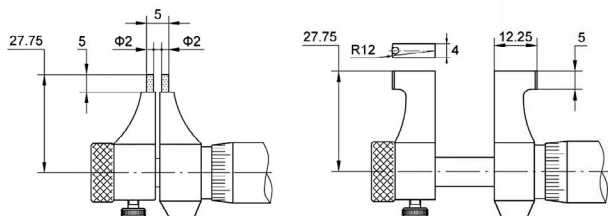



Mikrometry | Micrometres | Mikrometry

Mikrometr třídotekový (dutinoměr) - SADA, NOVÝ MODEL V HLINÍKOVÉM KUFRU

3-point Internal Micrometer with Setting Rings - SET, NEW MODEL, Al box

Średnicówka mikrometryczna do małych otworów - ZESTAW, NOWY MODEL W ALUMINIOWEJ OBUDOWIE

0,001

DIN
863



7089-03-040

CODE			sestava zostava zestaw	0
7089-03-003	0,004 mm	2 - 3 mm	2 - 2,5, 2,5 - 3 mm	2,5 mm
7089-03-006	0,004 mm	3 - 6 mm	3 - 4, 4 - 5, 5 - 6 mm	4, 5, 6 mm
7089-03-012	0,004 mm	6 - 12 mm	6 - 8, 8 - 10, 10 - 12 mm	6, 8, 10 mm
7089-03-020	0,004 mm	12 - 20 mm	12 - 16, 16 - 20 mm	16 mm
7089-03-040	0,004 mm	20 - 40 mm	20 - 25, 25 - 30, 30 - 40 mm	25, 40 mm
7089-03-100	0,005 mm	40 - 100 mm	40 - 50, 50 - 63, 62 - 75, 75 - 88, 87 - 100 mm	40, 62, 87 mm

7089-03-003, 7089-03-006 - pouze 2 doteky | only 2 touches | dwupunktowa

Mikrometr třídotekový (dutinoměr), NOVÝ MODEL V HLINÍKOVÉM KUFRU

3-point Internal Micrometer with Setting Rings - NEW MODEL, Al box

Średnicówka mikrometryczna do małych otworów, NOWY MODEL W ALUMINIOWEJ OBUDOWIE

D2 - 12
0,001

D16 - 300
0,005

DIN
863



7090-89-040



7089-02-100

CODE			0
7089-02-002	0,004 mm	2 - 2,5 mm	2,5 mm
7089-02-003	0,004 mm	2,5 - 3 mm	2,5 mm
7089-02-004	0,004 mm	3 - 4 mm	4 mm
7089-02-005	0,004 mm	4 - 5 mm	5 mm
7089-02-006	0,004 mm	5 - 6 mm	6 mm
7089-02-008	0,004 mm	6 - 8 mm	6 mm
7089-02-010	0,004 mm	8 - 10 mm	8 mm
7089-02-012	0,004 mm	10 - 12 mm	10 mm
7089-02-016	0,004 mm	12 - 16 mm	16 mm
7089-02-020	0,004 mm	16 - 20 mm	16 mm
7089-02-025	0,004 mm	20 - 25 mm	25 mm
7089-02-030	0,004 mm	25 - 30 mm	25 mm
7089-02-040	0,004 mm	30 - 40 mm	40 mm
7089-02-050	0,005 mm	40 - 50 mm	40 mm
7089-02-063	0,005 mm	50 - 63 mm	62 mm
7089-02-075	0,005 mm	62 - 75 mm	62 mm
7089-02-088	0,005 mm	75 - 88 mm	87 mm
7089-02-100	0,005 mm	87 - 100 mm	87 mm
7089-02-125	0,005 mm	100 - 125 mm	-
7089-02-150	0,005 mm	125 - 150 mm	-
7089-02-175	0,005 mm	150 - 175 mm	-
7089-02-200	0,005 mm	175 - 200 mm	-
7089-02-225	0,007 mm	200 - 225 mm	-
7089-02-250	0,007 mm	225 - 250 mm	-
7089-02-275	0,007 mm	250 - 275 mm	-
7089-02-300	0,007 mm	275 - 300 mm	-

Mikrometry jsou dodávány včetně prodloužení 100 mm (do pr. 12 mm) nebo 150 mm (od pr. 12mm)

Micrometers are supplied with extension 100 mm (to ø 12mm) or 150 mm (from ø 12mm)

Mikrometry są dostarczane wraz z przedłużeniem 100 mm (do śred. 12 mm) lub 150 mm (od śred. 12 mm)

DALŠÍ ROZMĚRY NA ZAKÁZKU
OTHER SIZES ON REQUEST
INNE WYMIARY NA ZAMÓWIENIE

NEW
LINE

Mikrometry | Micrometres | Mikrometry

Mikrometr třídotekový (dutinoměr) digitální - AI box, SADA
 3-point Digital Internal Micrometer with Setting Rings - SET, NEW MODEL, AI box
 Średnicówka mikrometryczna trójpunktowa elektroniczna - AI box, ZESTAW



0,001



7090-03-100

CODE		prodl. predí. przedł.	0
7090-03-003	2 - 3 mm	2 - 2,5, 2,5 - 3 mm	2,5 mm
7090-03-006	3 - 6 mm	3 - 4, 4 - 5, 5 - 6 mm	4, 5, 6 mm
7090-03-012	6 - 12 mm	6 - 8, 8 - 10, 10 - 12 mm	6, 8, 10 mm
7090-03-020	12 - 20 mm	12 - 16, 16 - 20 mm	16 mm
7090-03-050	20 - 50 mm	20 - 25, 25 - 30, 30 - 40, 40 - 50 mm	25, 40 mm
7090-03-100	50 - 100 mm	50 - 63, 62 - 75, 75 - 88, 87 - 100 mm	62, 87 mm

7090-03-003, 7090-03-006 - pouze 2 doteky | only 2 touches | dwupunktowa

Mikrometr třídotekový (dutinoměr) digitální - AI box
 3-point Digital Internal Micrometer with Setting Rings, NEW MODEL, AI box
 Średnicówka mikrometryczna trójpunktowa elektroniczna - AI box



0,001



7090-02-088

CODE		0
7090-02-002	2 - 2,5 mm	2,5 mm
7090-02-003	2,5 - 3 mm	2,5 mm
7090-02-004	3 - 4 mm	4 mm
7090-02-005	4 - 5 mm	5 mm
7090-02-006	5 - 6 mm	6 mm
7090-02-008	6 - 8 mm	6 mm
7090-02-010	8 - 10 mm	8 mm
7090-02-012	10 - 12 mm	10 mm
7090-02-016	12 - 16 mm	16 mm
7090-02-020	16 - 20 mm	16 mm
7090-02-025	20 - 25 mm	25 mm
7090-02-030	25 - 30 mm	25 mm
7090-02-040	30 - 40 mm	40 mm
7090-02-050	40 - 50 mm	40 mm
7090-02-063	50 - 63 mm	62 mm
7090-02-075	62 - 75 mm	62 mm
7090-02-088	75 - 88 mm	87 mm
7090-02-100	87 - 100 mm	87 mm
7090-02-125	100 - 125 mm	-
7090-02-150	125 - 150 mm	-
7090-02-175	150 - 175 mm	-
7090-02-200	175 - 200 mm	-
7090-02-225	200 - 225 mm	-
7090-02-250	225 - 250 mm	-
7090-02-275	250 - 275 mm	-
7090-02-300	275 - 300 mm	-

Mikrometry jsou dodávány včetně prodloužení
 100 mm (do pr. 12 mm) nebo 150 mm (od pr. 12 mm)

Micrometers are supplied with extension
 100 mm (to ø 12mm) or 150 mm (from ø 12mm)

Mikrometry są dostarczane wraz z przedłużeniem
 100 mm (do śred. 12 mm) lub 150 mm (od śred. 12 mm)

Mikrometry malých průměrů (do pr. 6 mm)
 jsou dodávány pouze se 2 dotyky

Mikrometre malých priemerov (do pr. 6 mm)
 sú dodávané iba s 2 dotykmi

Mikrometry o malých średnicach (do śred. 6 mm)
 są dwupunktowe





Mikrometry | Micrometres | Mikrometry

Mikrometr dutinový (dutinoměr) - analogový úchylkoměr
Dial Bore Gauge with Dial Micrometer
Średnicówka czujnikowa dwupunktowa - analogowa

DIN
863





CODE		
7110-0	0,01 mm	6 - 10 mm
7110-1	0,01 mm	10 - 18 mm
7110-2	0,01 mm	18 - 35 mm
7110-3	0,01 mm	35 - 50 mm
7110-5	0,01 mm	50 - 160 mm
7110-6	0,01 mm	160 - 250 mm
7110-7	0,01 mm	250 - 450 mm

Mikrometr dutinový (dutinoměr) - digitální úchylkoměr
Dial Bore Gauge with Digital Micrometer
Średnicówka czujnikowa dwupunktowa - elektroniczna

DIN
863





CODE		
7110-80	0,001 mm	6 - 10 mm
7110-81	0,001 mm	10 - 18 mm
7110-82	0,001 mm	18 - 35 mm
7110-83	0,01 mm	35 - 50 mm
7110-85	0,01 mm	50 - 160 mm
7110-86	0,01 mm	160 - 250 mm
7110-87	0,01 mm	250 - 450 mm

Mikrometr dutinový (dutinoměr) - analogový úchylkoměr
Dial Bore Gauge with Dial Micrometer
Średnicówka czujnikowa dwupunktowa - analogowa

DIN
863





CODE		
7110-90	0,001 mm	6 - 10 mm
7110-91	0,001 mm	10 - 18 mm
7110-92	0,001 mm	18 - 35 mm
7110-93	0,001 mm	35 - 50 mm
7110-94	0,001 mm	50 - 160 mm
7110-95	0,001 mm	160 - 250 mm
 7110-96	0,001 mm	250 - 450 mm

Mikrometrické odpichy
Internal Measurement Micrometer
Średnicówka mikrometryczna składana

DIN
863



CODE		
7125-12	0,01 mm	50 - 75 mm
7125	0,01 mm	50 - 600 mm
7125-3	0,01 mm	100 - 2100 mm
7125-1	nástavec extension przedłużenie 200 mm	
7125-2	nástavec extension przedłużenie 100 mm	

Mikrometry | Micrometres | Mikrometry

Pasometr - Profesional
Indicator Micrometer Professional
Mikrometr z czujnikiem - Profesional

DIN
863

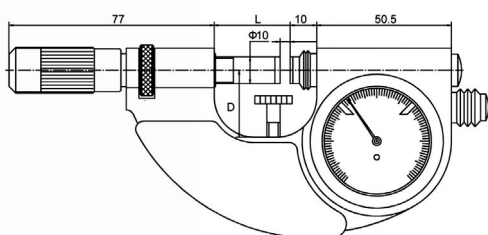

CODE	L [mm]	D [mm]		
7126-02-025	28,5	25,0	0,001 mm	0 - 25 mm
7126-02-050	53,5	35,0	0,001 mm	25 - 50 mm
7126-02-075	78,5	47,5	0,001 mm	50 - 75 mm
7126-02-100	103,5	60,0	0,001 mm	75 - 100 mm

Supplied with the Measuring Protocol.
Dodávané vrátane protokolu o premeraní.
Dostarczamy wraz z protokołem z pomiarzenia.

Pasometr (mikropasometr)
Indicator Micrometer
Mikrometr z czujnikiem

DIN
863



CODE		
7126	0,001 mm	0 - 25 mm
7126-1	0,001 mm	25 - 50 mm
7126-2	0,001 mm	50 - 75 mm
7126-3	0,001 mm	75 - 100 mm

Mikrometrický hloubkoměr
Depth Micrometer
Głębokościomierz mikrometryczny

DIN
863



7103-02-025



7103

CODE			
7103	0,01 mm	0 - 100 mm	analog
7103-02-025	0,001 mm	0 - 25 mm	digital

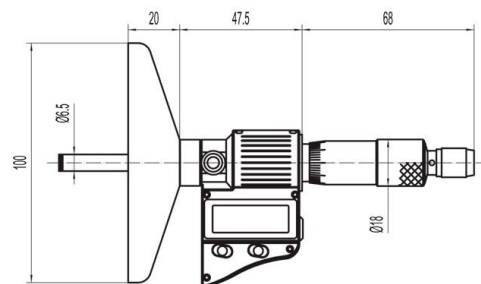



Mikrometry | Mikrometre | Mikrometry

Mikrometrická hlavice
Micrometer Head
Głowica mikrometryczna

DIN
863



CODE		
7120	0,01 mm	0 - 25 mm
7120-02-025	0,01 mm	0 - 25 mm krátké prov. short version wersja skrócona

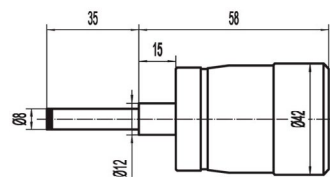

Svinovací metry | Measuring Tapes | Miary zwijane

Svinovací metr KINEX - doporučujeme pro kalibrace
Tape Measure KINEX - Recommended for Calibration
Miara zwijana KINEX - zalecana do wzorcowania

II
class

ČSN
25 1141



CODE		
8001	2 m	13 mm
8002	3 m	13 mm
8003	5 m	16 mm

Svinovací metr KINEX
Tape Measure KINEX
Miara zwijana KINEX

CE

I
class



CODE		
8002-02-003	3 m	13 mm
8002-02-005	5 m	19 mm
8002-02-008	8 m	25 mm
8002-02-010	10 m	25 mm

Svinovací metry | Measuring Tapes | Miary zwijane

Svinovací metr KINEX Speciál
Tape Measure KINEX Special
Miara zwijana KINEX Special



CODE		
8001-3	2 m	13 mm
8002-3	3 m	13 mm
8003-3	5 m	19 mm
8004-3	8 m	25 mm

Svinovací metr KOMELON - SELF LOCK, otěruvzdorná páska
Tape Measure KOMELON - SELF LOCK, Resistant Tape
Miara zwijana KOMELON - SELF LOCK, odporna na ścieranie



CODE		
8039-3	3 m	16 mm
8039-5	5 m	19 mm

Svinovací metr KOMELON - PRO ERGO, otěruvzdorná páska
Tape Measure KOMELON - PRO ERGO, Resistant Tape
Miara zwijana KOMELON - PRO ERGO, odporna na ścieranie



CODE		
8040-1	2 m	16 mm
8040-2	3 m	16 mm
8040-3	5 m	19 mm
8040-4	8 m	25 mm

Svinovací metr KOMELON, ECO PEN
Tape Measure KOMELON, ECO PEN
Miara zwijana KOMELON, ECO PEN



CODE		
8041-2	3 m	16 mm
8042-2	5 m	19 mm
8043-2	8 m	25 mm



Svinovací metry | Measuring Tapes | Miary zwijane

Svinovací metr FESTA - EEC cert., aut. brzda (autolock), pogumování
Tape Measure FESTA - EEC cert., AUTOLOCK, Rubber Case
Miara zwijana FESTA - EEC certyfikat, autolock, guma

Svinovací metr FESTA, pogumovaný s magnetem
Tape Measure FESTA, Rubber Case, Magnet on Hook
Miara zwijana FESTA, gumowana z magnesem



CODE	Length	Width
8044-20	3 m	16 mm
8044-21	5 m	19 mm
8044-22	7,5 m	25 mm

CODE	Length	Width
8044-10	2 m	16 mm
8044-11	3 m	16 mm
8044-12	5 m	19 mm
8044-13	7,5 m	25 mm
8044-14	10 m	25 mm

Diametr - svinovací metr pro měření průměru

Circumference Tape

Diametr - do pomiaru grubości



CODE	Length	Width
8005	2 m	10 mm



Svinovací metry | Measuring Tapes | Miary zwijane

Svinovací metr JOHNEY
Tape Measure JOHNEY
Miara zwijana JOHNEY



Svinovací metr FESTA - velké číslice
Tape Measure FESTA - Large Numbers
Miara zwijana FESTA - z dužými cyframi



CODE	— —	↔
8040	2 m	13 mm
8041	3 m	13 mm
8042	5 m	13 mm
8042-1	5 m	19 mm
8043	7,5 m	19 mm

CODE	— —	↔
8044-15	2 m	16 mm
8044-16	3 m	19 mm
8044-17	5 m	19 mm

Svinovací metr KINEX HOBBY LINE II
Tape Measure KINEX HOBBY LINE II
Miara zwijana KINEX HOBBY LINE II



CODE	— —	↔
8001-2	2 m	13 mm
8002-2	3 m	13 mm
8003-2	5 m	19 mm
8004-2	7,5 m	25 mm
8004-2-1	10 m	25 mm



Pásma | Long Tapes | Miary zwijane

Pásmo KINEX - ocelová páska, pro kalibrace
 Long Steel Tape KINEX - Recomm. for Calibration
 Taśma stalowa zalecana do wzorcowania

ČSN
25 1150

II
class



CODE	Length	Width
8010	10 m	13 mm
8011	20 m	13 mm
8012	25 m	13 mm
8013	30 m	13 mm
8014	50 m	13 mm

Pásmo KINEX - ocelová páska, polyamid úprava
 Long Steel Tape KINEX, polyamid
 Taśma stalowa KINEX - polyamid

CE

I
class



CODE	Length	Width
8017-02-030	30 m	13 mm
8017-02-050	50 m	13 mm

Pásmo KINEX s rukojetí, ocelová páska
 Long Steel Tape KINEX with Handle
 Taśma stalowa KINEX z uchwytem

ČSN
25 1151

II
class



CODE	Length	Width
8017	10 m	13 mm
8018	20 m	13 mm
8019	25 m	13 mm
8020	30 m	13 mm
8021	50 m	13 mm

Pásmo KOMELON ve vidlici, sklo-laminátová el. nevodivá páska
 Long Steel Tape Komelon KOMELON - Laminate Tape
 Taśma KOMELON - widełki, szkło i laminat, nieprzewodząca prąd elektr.

CE



CODE	Length	Width
8054-0	30 m	13 mm
8054-1	50 m	13 mm
8054	100 m	13 mm

Pásma | Long Tapes | Miary zwijane

Pásma KOMELON - sklo-laminátová páska
Long Tape KOMELON - Laminat
Taśma KOMELON szkło - laminat



CODE	Length	Width
8045	10 m	13 mm
8046	20 m	13 mm
8047	30 m	13 mm
8048	50 m	13 mm

Pásma KOMELON, ocelová páska
Long Steel Tape KOMELON
Taśma stalowa KOMELON



CODE	Length	Width
8055	10 m	10 mm
8055-1	20 m	10 mm
8055-2	30 m	10 mm

Pásma KINEX Hobby line I, ocelová páska
Long Steel Tape FESTA with tiltable hook
Taśma stalowa KINEX - HOBBY LINE I



CODE	Length	Width
8050	10 m	10 mm
8051	20 m	10 mm
8052	30 m	10 mm
8053	50 m	10 mm

Měřicí kolečko
Long Steel Tape KINEX Hobby line I
Drogomierz

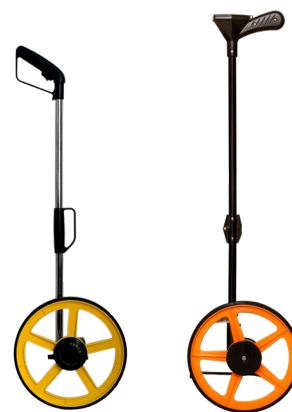

8057-02-300

8057-15-320

CODE	Length	Width	Weight	Diameter	Type
8057-02-300	1010 / 510 mm	1530g	D 318 mm	analog	
8057-15-320	1100 / 620 mm	1700g	D 318 mm	digital	

Páska s mm dělením rovná ke strojům 3m
Steel Tape with mm graduation for Machines - 3m
Taśma z mm podziałką 3m



CODE	Length	Width
8002-10	3 m	13 mm

Na zakázku nabízíme dodání pásky v různých délkách, v bílém nebo žlutém provedení, se stupnicí zleva doprava i zprava doleva.

We offer custom delivery tapes in various lengths, in white or yellow design, with a scale from left to right and right to left.

Oferujemy niestandardowe taśmy w różnych długościach, w kolorze białym lub żółtym w wersji ze skalą od lewej do prawej lub od prawej do lewej.



Sady | Sady | Zestawy

Prezentační sada v boxu
Presentation Set in boxing
Reprezentacyjny box produktów

**NEW
LINE**



CODE

7171-01-006

sada obsahuje:
set contains:
zestaw zawiera:

6040-27-150

6040-05-150

1155-05-010

7030-27-030

7030-05-025

4026-28-006

Sada mezních válečkových kalibrů
Set of Plug Gauges
Zestaw sprawdzianów do gwintów metrycznych

**NEW
LINE**



CODE

92000-H7-012

sada obsahuje:
set contains:
zestaw zawiera:

92003H7 3H7

92004H7 4H7

92005H7 5H7

92006H7 6H7

92008H7 8H7

92010H7 10H7

92012H7 12H7

Sada mezních závitových kroužků
Set of Thread Ring Gauges
Zestaw mierników gwintowanych, pierścienie

**NEW
LINE**



CODE

94000-6g-12D

94000-6g-12Z

sada obsahuje:
set contains:
zestaw zawiera:

94003-6g M3

94004-6g M4

94005-6g M5

94006-6g M6

94008-6g M8

94010-6g M10

94012-6g M12

Sada mezních závitových trnů
Set of Thread Plug Gauges
Zestaw sprawdzianów, szpilki gwintowane

**NEW
LINE**



CODE

93000-6H-012

sada obsahuje:
set contains:
zestaw zawiera:

93003-6H M3

93004-6H M4

93005-6H M5

93006-6H M6

93008-6H M8

93010-6H M10

93012-6H M12

Sada zámečnických příložných úhelníků
Try Squares Set
Zestaw kątowników ze stopką

**NEW
LINE**



CODE

S444-43-250

sada obsahuje:
set contains:
zestaw zawiera:

4020

4021

4022

Sada měřidel
Measuring Tools Set
Zestaw uniwersalny

**NEW
LINE**



CODE

S678-32-0001

sada obsahuje:
set contains:
zestaw zawiera:

6000

7002

8001

Kalibry | Gauges | Sprawdziany

Nastavovací kroužek DIN2250C
Setting Ring DIN 2250 C
Sprawdzian pierścieniowy DIN2250C



CODE	
91002	D 2 mm
91002,5	D 2,5 mm
91003	D 3 mm
91003,5	D 3,5 mm
91004	D 4 mm
91004,5	D 4,5 mm
91005	D 5 mm
91006	D 6 mm
91007	D 7 mm
91008	D 8 mm
91009	D 9 mm
91010	D 10 mm
91011	D 11 mm
91012	D 12 mm
91013	D 13 mm
91014	D 14 mm
91015	D 15 mm
91016	D 16 mm
91017	D 17 mm
91018	D 18 mm
91019	D 19 mm
91020	D 20 mm
91022	D 22 mm
91024	D 24 mm
91025	D 25 mm
91026	D 26 mm
91027	D 27 mm
91028	D 28 mm
91029	D 29 mm
91030	D 30 mm
91032	D 32 mm
91033	D 33 mm
91034	D 34 mm
91035	D 35 mm

CODE	
91036	D 36 mm
91038	D 38 mm
91040	D 40 mm
91042	D 42 mm
91044	D 44 mm
91045	D 45 mm
91046	D 46 mm
91050	D 50 mm
91055	D 55 mm
91060	D 60 mm
91065	D 65 mm
91070	D 70 mm
91075	D 75 mm
91080	D 80 mm
91085	D 85 mm
91090	D 90 mm
91095	D 95 mm
91100	D 100 mm
91112,5	D 112,5 mm
91125	D 125 mm
91137,5	D 137,5 mm
91150	D 150 mm
91162,5	D 162,5 mm
91175	D 175 mm
91187,5	D 187,5 mm
91200	D 200 mm
91225	D 225 mm
91250	D 250 mm
91275	D 275 mm
91300	D 300 mm



Kompletní sortiment kalibrů v samostatném katalogu!
Complete range of Gauges in separate catalog!
Kompletny asortyment sprawdzianów w oddzielnym katalogu!
ONLINE: www.kinexmeasuring.com/KATALOG_KALIBRY_CZSKPL.pdf



Kalibry | Gauges | Sprawdziany

Mezní válečkový kalibr DIN 7162, DIN 7164

Plug Gauge DIN 7162, DIN 7164

Sprawdzian graniczny tłoczkowy DIN 7162, DIN 7164



Řada kalibrů H8 skladem
Gauges series H8 in stock
Sprawdziany serii H 8 w magazynie

CODE	
92002H7	D 2 H7
92002,5H7	D 2,5 H7
92003H7	D 3 H7
92004H7	D 4 H7
92005H7	D 5 H7
92006H7	D 6 H7
92007H7	D 7 H7
92008H7	D 8 H7
92009H7	D 9 H7
92010H7	D 10 H7
92011H7	D 11 H7
92012H7	D 12 H7
92013H7	D 13 H7
92014H7	D 14 H7
92015H7	D 15 H7
92016H7	D 16 H7
92017H7	D 17 H7
92018H7	D 18 H7
92019H7	D 19 H7
92020H7	D 20 H7
92021H7	D 21 H7
92022H7	D 22 H7
92023H7	D 23 H7
92024H7	D 24 H7
92025H7	D 25 H7
92026H7	D 26 H7
92027H7	D 27 H7
92028H7	D 28 H7
92029H7	D 29 H7
92030H7	D 30 H7

CODE	
92031H7	D 31 H7
92032H7	D 32 H7
92033H7	D 33 H7
92034H7	D 34 H7
92035H7	D 35 H7
92036H7	D 36 H7
92037H7	D 37 H7
92038H7	D 38 H7
92039H7	D 39 H7
92040H7	D 40 H7
92041H7	D 41 H7
92042H7	D 42 H7
92043H7	D 43 H7
92044H7	D 44 H7
92045H7	D 45 H7
92046H7	D 46 H7
92047H7	D 47 H7
92048H7	D 48 H7
92050H7	D 50 H7
92052H7	D 52 H7
92055H7	D 55 H7
92060H7	D 60 H7
92065H7	D 65 H7
92070H7	D 70 H7
92075H7	D 75 H7
92080H7 *	D 80 H7
92085H7 *	D 85 H7
92090H7 *	D 90 H7
92095H7 *	D 95 H7
92100H7 *	D 100 H7

* dobrá i zmetková strana se samostatnou rukojetí

* Go and NoGo side with separate handle

* przechodnia i nieprzechodnia część z oddzielnym uchwytem

Kalibry | Gauges | Sprawdziany

Mezní závitový trn - Metrický závit M, DIN 13
 Thread Plug Gauge - Metric Thread M, DIN 13
 Sprawdzian graniczny do gwintów metrycznych M, DIN 13



CODE	
93002-6H	D M2- 6H
93002,5-6H	D M2,5- 6H
93003-6H	D M3- 6H
93003,5-6H	D M3,5- 6H
93004-6H	D M4- 6H
93004,5-6H	D M4,5- 6H
93005-6H	D M5- 6H
93006-6H	D M6- 6H
93007-6H	D M7- 6H
93008-6H	D M8-6H
93009-6H	D M9-6H
93010-6H	D M10- 6H
93012-6H	D M12- 6H
93014-6H	D M14- 6H
93016-6H	D M16- 6H
93018-6H	D M18- 6H
93020-6H	D M20- 6H
93022-6H	D M22- 6H
93024-6H	D M24- 6H
93027-6H	D M27- 6H
93030-6H	D M30- 6H
93033-6H	D M33- 6H
93036-6H	D M36- 6H
93039-6H	D M39- 6H
93042-6H	D M42- 6H
93045-6H	D M45- 6H
93048-6H	D M48- 6H

Mezní závitový trn - trubkový závit G, DIN EN ISO 228
 Thread Plug Gauge - Pipe Thread G, DIN EN ISO 228
 Sprawdzian graniczny do gwintów rurowych G, DIN EN ISO 228



CODE	
93301	G 1/16"
93302	G 1/8"
93303	G 1/4"
93304	G 3/8"
93305	G 1/2"
93306	G 5/8"
93307	G 3/4"
93308	G 7/8"
93309	G 1"
93310	G 1 1/8"
93311	G 1 1/4"
93312	G 1 1/2"
93313	G 1 3/4"
93314	G 2"
93315	G 2 1/4"
93316	G 2 1/2"
93317	G 2 3/4"
93318 *	G 3"
93319 *	G 3 1/2"
93320 *	G 4"
93321 *	G 4 1/2"
93322 *	G 5"
93323 *	G 5 1/2"
93324 *	G 6"

- * dobrá i zmetková strana se samostatnou rukojetí
- * Go and NoGo side with separate handle
- * przechodnia i nieprzechodnia część z oddzielnym uchwytem

Jemné stoupání závitových kalibrů skladem

Fine-pitch Gauges in stock

Sprawdziany o małym skoku gwintu posiadamy na magazynie



Kalibry | Gauges | Sprawdziany

Mezní závitový kroužek - dobrý, DIN 13
Thread Ring Gauge - Metric Thread - Go, DIN 13
Sprawdzian pierścieniowy do gwintów metrycznych - przechodni, DIN 13

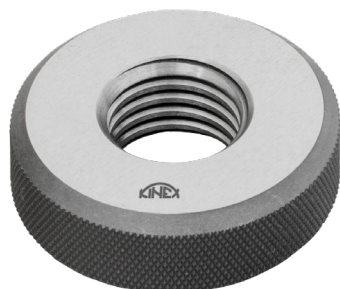

CODE	
94002-6gD	D M2-6g
94002,5-6gD	D M2,5-6g
94003-6gD	D M3-6g
94003,5-6gD	D M3,5-6g
94004-6gD	D M4-6g
94005-6gD	D M5-6g
94006-6gD	D M6-6g
94007-6gD	D M7-6g
94008-6gD	D M8-6g
94009-6gD	D M9-6g
94010-6gD	D M10-6g
94012-6gD	D M12-6g
94014-6gD	D M14-6g
94016-6gD	D M16-6g
94018-6gD	D M18-6g
94020-6gD	D M20-6g
94022-6gD	D M22-6g
94024-6gD	D M24-6g
94027-6gD	D M27-6g
94030-6gD	D M30-6g
94033-6gD	D M33-6g
94036-6gD	D M36-6g
94039-6gD	D M39-6g
94042-6gD	D M42-6g
94045-6gD	D M45-6g
94048-6gD	D M48-6g

Mezní závitový kroužek - trubkový závit G, dobrý, DIN EN ISO 228
Thread Ring Gauge - Pipe Thread G, Go, DIN EN ISO 228
Sprawdzian do gwintów metrycznych G - przechodni, DIN EN ISO 228

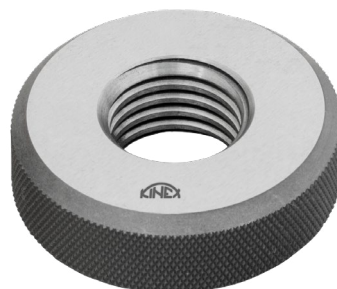

CODE	
94301D	G 1/16"
94302D	G 1/8"
94303D	G 1/4"
94304D	G 3/8"
94305D	G 1/2"
94306D	G 5/8"
94307D	G 3/4"
94308D	G 7/8"
94309D	G 1"
94310D	G 1 1/8"
94311D	G 1 1/4"
94312D	G 1 1/2"
94313D	G 1 3/4"
94314D	G 2"
94315D	G 2 1/4"
94316D	G 2 1/2"
94317D	G 2 3/4"
94318D	G 3"

Jemné stoupání kalibrů skladem
Fine Pitch Gauges in stock
Sprawdziany o małym skoku gwintu posiadamy na magazynie

Kalibry | Gauges | Sprawdziany

Mezní závitový kroužek - zmetkový, DIN 13
 Thread Ring Gauge - Metric Thread - NoGo, DIN 13
 Sprawdzian pierścieniowy do gwintów metrycznych - nieprzechodni, DIN 13

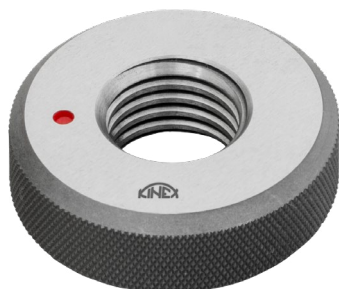

CODE	
94002-6gZ	D M2-6g
94002,5-6gZ	D M2,5-6g
94003-6gZ	D M3-6g
94003,5-6gZ	D M3,5-6g
94004-6gZ	D M4-6g
94005-6gZ	D M5-6g
94006-6gZ	D M6-6g
94007-6gZ	D M7-6g
94008-6gZ	D M8-6g
94009-6gZ	D M9-6g
94010-6gZ	D M10-6g
94012-6gZ	D M12-6g
94014-6gZ	D M14-6g
94016-6gZ	D M16-6g
94018-6gZ	D M18-6g
94020-6gZ	D M20-6g
94022-6gZ	D M22-6g
94024-6gZ	D M24-6g
94027-6gZ	D M27-6g
94030-6gZ	D M30-6g
94033-6gZ	D M33-6g
94036-6gZ	D M36-6g
94039-6gZ	D M36-6g
94042-6gZ	D M42-6g
94045-6gZ	D M45-6g
94048-6gZ	D M48-6g

Mezní závitový kroužek - trubkový závit G, zmetkový, DIN EN ISO 228
 Thread Ring Gauge - Pipe Thread G, NoGo, DIN EN ISO 228
 Sprawdzian do gwintów metrycznych G - nieprzechodni, DIN EN ISO 228

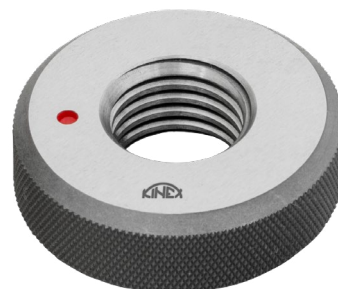

CODE	
94301Z	G 1/16"
94302Z	G 1/8"
94303Z	G 1/4"
94304Z	G 3/8"
94305Z	G 1/2"
94306Z	G 5/8"
94307Z	G 3/4"
94308Z	G 7/8"
94309Z	G 1"
94310Z	G 1 1/8"
94311Z	G 1 1/4"
94312Z	G 1 1/2"
94313Z	G 1 3/4"
94314Z	G 2"
94315Z	G 2 1/4"
94316Z	G 2 1/2"
94317Z	G 2 3/4"
94318Z	G 3"



Široký sortiment kalibrů skladem
 Wide range of Gauges in stock
 Różnego typu sprawdz. mamy na magazynie
BSW, UNC, UN(E)F, TR, Pg, Rp / R, NPT(F)

Kompletní sortiment kalibrů v samostatném katalogu!
 Complete range of Gauges in separate catalog!
 Kompletny asortyment sprawdzianów w oddzielnym katalogu!
 ONLINE: www.kinexmeasuring.com/KATALOG_KALIBRY_CZSKPL.pdf



Doplňkový sortiment | Additional assortment | Dodatkowy asortyment

Úhelník dřevěný, stolařský
Wooden Square
Kątownik drewniany stolarski



CODE	↔
4065	300x250 mm
4066	400x200 mm
4067	500x250 mm

Kosořez dřevěný 280x90x60mm /60°
Wooden Angle Holder 280x90x60mm /60°
Drewniany szablon do skosów



CODE	↔	↔
9001	60°	280x90x60 mm

Úhломěr dřevěný
Bevel Protractor - Wooden Type
Kątomierz drewniany



CODE	↔	↔
9002	30°, 45°, 60° a 90°	250 mm

Rejsek
Wooden Marking Gauge
Rysik słupkowy traserski

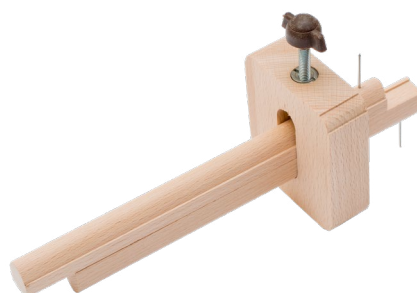

CODE	↔
9003	250x100 mm

Pravítko KINEX cejchované 1m - pro prodejny a provozy s metráží
Bevel Protractor - Wooden Type
Przymiar drewniany cechowany - dla sklepów i do operacji z metrazem



CODE	↔	↔
1072	1 m	35x9 mm

Platnost cejchu od státní zkušebny je daný rok + dva následující.
The validity of the mark from the State Examination Office
is given year + two following.

Ważność miary po badaniach państwowych na rok + dwa następujące.

Měřítko dřevěné
Wooden Rule
Przymiar drewniany

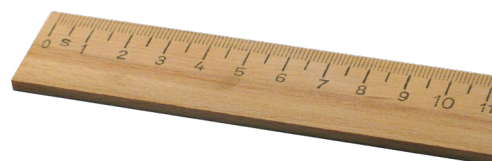

CODE	↔	↔
1070-02-030	300 mm	35x7mm
1070-02-050	500 mm	35x7mm
1070-02-100	1000 mm	37x6mm

Doplňkový sortiment | Additional assortment | Dodatkowy asortyment

Měřicí teleskopická tyč
Telescopic Measuring 3m
Przymiar teleskopowy



CODE	
1054	3 m
1055	5 m
1056	8 m

Skládací dřevěný metr PROFI
Wooden Folding Ruler
Miara składana drewniana z obrzeżem metalowym PROFI



CODE		
8060	1 m	16 mm
8065	2 m	16 mm
8067	3 m	16 mm

Krejčovský metr samonavíjecí 1,5m
Tailor Tape automatic 1,5m
Metr krawiecki rozwijany 1,5m



CODE	
8074	1,5 m

Skládací plastový metr
Plastic Folding Ruler
Miara składana z tworzywa



CODE		
8070	1 m	15 mm
8071	2 m	15 mm

Dálkoměr laserový PD23
Laser Distancer PD23
Dalmierz laserowy PD23



CODE		
9040-700	30 m	± 2 mm

Dálkoměr laserový - PROFESSIONAL
Digital Laser Distance Meter 50m - NEW DESIGN
Dalmierz laserowy - PROFESSIONAL



CODE		
9040-02-050	50 m	± 2 mm
9040-02-060	60 m	± 2 mm
9040-02-070	70 m	± 2 mm
9040-02-080	80 m	± 2 mm
9040-02-100	100 m	± 2 mm



Doplňkový sortiment | Additional assortment | Dodatkowy asortyment

Samonivelační křížový laser, horizontální a vertikální paprsek
Cross Laser KINEX - Autolevel, Magnetic Holder
Samopoziomujący laser krzyżowy, promień poziomy i pionowy



CODE

9040-900

10 m

± 1 mm/1m

1x vertikální + 1 horizontální paprsek + 5x bod
1x vertical + 1x horizontal beam + 5x point
1x pionowy + 1x poziomy promień + 5x punkt

Samonivelační křížový laser LP103, horizontální a vertikální paprsek
Laser LP103 Cross Laser, horizontal and vertical beam
Samopoziomujący laser krzyżowy LP103, promień poziomy i pionowy



CODE

9040-935

15 m

± 1 mm/1m

1x vertikální + 1 horizontální paprsek
1x vertical + 1x horizontal beam
1x pionowy + 1x poziomy promień

Lasery



baublys

Made in Germany

LASER vláknový

MOŽNÉ APLIKACE POPISU MATERIÁLU

UV popis pro automatické linky
povrchová úprava
mikro popis
popis žiháním
gravírování / rytí
barevné popisy

Stolní laser **Baublys BL2000** je vybaven nejmodernějším vláknovým laserem s dlouhou životností. Je vybaven na velmi kompaktním prostoru stejnou efektivní technologií jako naše průmyslové značení a rytí.

Systémový software je snadno ovladatelný, flexibilní a nabízí optimální řešení pro kvalitní značení na různých materiálech (plasty, kompozitní materiály, keramika, kov a další). Vše v nejlepší poměru cena/výkon.

BL2000 je bezúdržbový a vyžaduje pouze obvyklou zásuvku na 230V.

HMI Interface

Kompletní nově navržený a vyvinutý operační systém HMI s dotykovou obrazovkou. Ovládací a programovací software je založen na systému Windows 7 / Windows 10. Dlouholetá zkušenost s aplikací gravírování a značení zajišťuje intuitivní a jednoduché programování.



Profesionální upínání materiálu

Pro profesionální polohování a kalibraci obrobku.



Odvod spalin

Výkonné zařízení pro odsávání kouře a prachu.

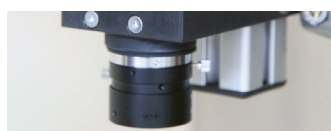

Kamerové systémy

Kamerový systém ke sledování pracovního procesu.



Optické vlastnosti

Různé verze optiky umožňují přizpůsobit oblast popisu, a kvalitu rozlišení.

SPECIFIKACE VÝROBKU

Typ laseru	Ytterbiuové vlákno	Ovládání	CNC control
Vlnová délka laseru	1064 nm	System software	Windows 7 / Windows 10
Pulsní frekvence	20 - 200 kHz	Rozměry (D x Š x V)	800 x 600 x 900 mm
Napájení	10 - 100 W	Připojení k síti	Ano
Oblast popisu	180 x 180 mm		

www.elaser.sk

+420 724 486 318
lasery@kinexmeasuring.com
<http://www.kinexmeasuring.com>



baublys

Made in Germany

LASER vláknový

MOŽNÉ APLIKACE POPISU MATERIÁLU

UV popis pro automatické linky
 povrchová úprava
 mikro popis
 popis žháním
 gravírování / rytí
 barevné popisy

Kompaktní, robustní, spolehlivý, to jsou vlastnosti řady **BL3000**. Stroj je vyroben na základě osvědčených řešení, spárovaný s nejnovějšími laserovými technologiemi. Extrémně atraktivní poměr cena / výkon. Velký prostor pro zpracování materiálu, zvyšuje flexibilitu uživatele.

Všechny technologické procesy lze provádět univerzálně a to ve všech typech materiálů. Pro tento stroj jsou k dispozici všechny typy a výkonnosti laserů.

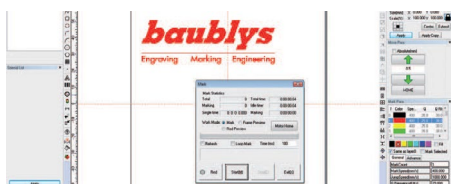

HMI Interface

Ovládací software byl zaměřen tak, aby jej zvládli běžní zaměstnanci v provozu výroby a zároveň modulárně postavený tak, aby byla možná další rozšíření aplikací pro složitější implementace - například na automatické lince.



Optika

Různé verze optiky umožňují přizpůsobit oblast popisu a kvalitu rozlišení.

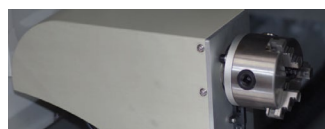

Indexování příloh

Malé a kompaktní pro standardní popisy nebo rotační aplikace asymetrických součástí.



Modul čárového kódu

Pro snadné a pohodlné vytváření kódů a následné označování obrobků.



Odvod zplodin

Výkonné zařízení pro extrakci organických a anorganických částic.

MODULÁRNÍ MOŽNOSTI LASERU BL3000

Typ laseru	UV laser	zelený laser	vláknový laser	CO2 laser
Vlnová délka laseru	355 nm	532 nm	1064 nm	10,6 μm
Pulsní frekvence	10 - 200 kHz	10 - 200 kHz	20 - 200 kHz	cw
Napájení	3 - 8 W	10 - 20 W	10 - 50 W	10 - 50 W
Oblast popisu	na vyžádání	max. 160 x 160 mm	max. 160 x 160 mm	max. 300 x 300 mm
Ovládání			NC control	
System software			Windows 7	
Rozměry (D x Š x V)			800 x 1148 x 1750 mm	
Připojení k síti			Ano	

BEZDRÁTOVÉ MĚŘENÍ



Iconic Space

DIGITALIZACE MĚŘENÍ JEDNODUŠE VE 3 KROCÍCH



**BEZDRÁTOVÁ
MĚŘIDLA**

**AUTOMATICKÝ
SBĚR DAT**

**STATISTICKÁ
REGULACE PROCESU**

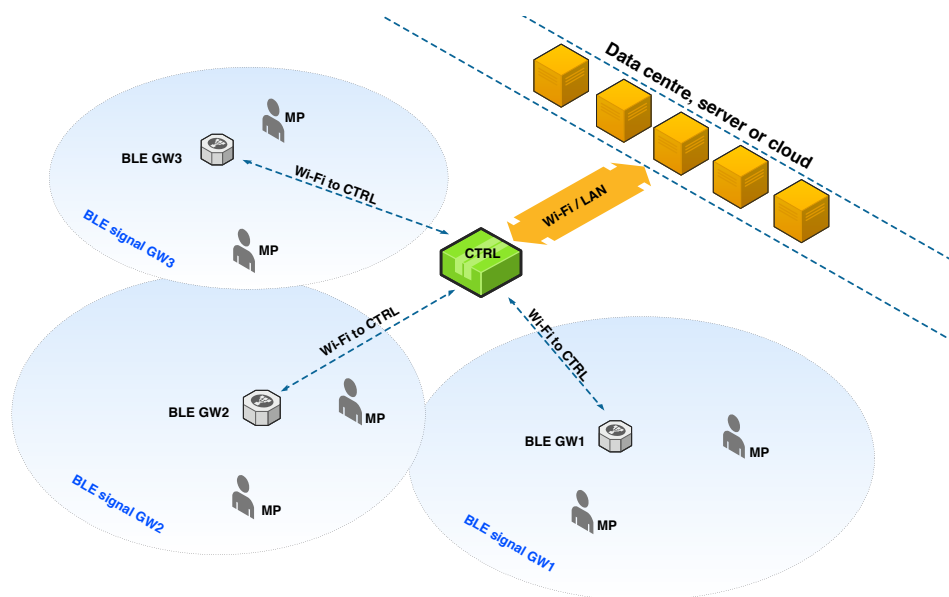

BLE signál - signál pro připojení měřidel
BLEGW (1, 2, 3) - Bluetooth Gateway
MP - měřicí pracoviště
CTRL - Kontrolér
BLEGW - Gateway přenáší data do CTRL nebo přímo do Wi-Fi sítě, zajišťuje automatické připojení měřidla, umožňuje roaming, dálková správa
CTRL - Kontrolér přenáší data z BLEGW do aplikací, řídí a konfiguruje všechny BLEGW univerzální formát dat na výstupu, hostuje aplikace jako je SPC atd., dálková správa

KINEX Measuring s.r.o.

Podnikatelská 586, 190 11 Praha 9
 +420 724 486 318
 ispace@kinexmeasuring.com

STÁVAJÍCÍ DOKUMENTACE

Použijete vaše výkresy, kontrolní plány, případně jiné podklady v papírové nebo digitální podobě.

DIGITALIZACE PRACOVIŠTĚ

Dodáme bezdrátová měřidla a digitální infrastrukturu, integrujeme do vašeho procesu.

SPC V REÁLNÉM ČASE

Naše SPC aplikace vytvoří regulační diagramy a histogramy v reálném čase nebo můžeme data integrovat přímo do vašeho existujícího systému.

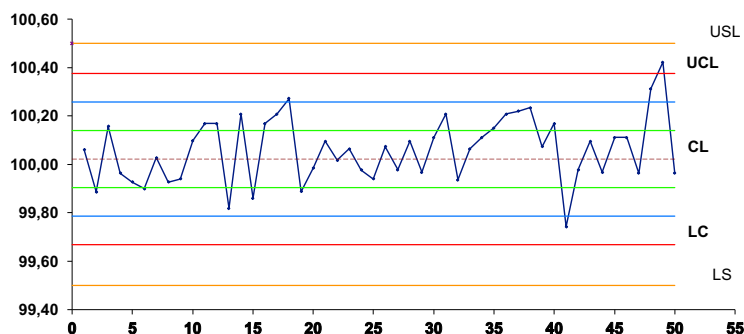

WWW.ICONIC-SPACE.COM



WIRELESS MEASUREMENT



Iconic Space

DIGITIZATION OF MEASUREMENTS SIMPLY IN 3 STEPS



**WIRELESS
GAUGES**

**AUTOMATICALLY
DATA COLLECTION**

**STATISTICAL
PROCESS REGULATION**

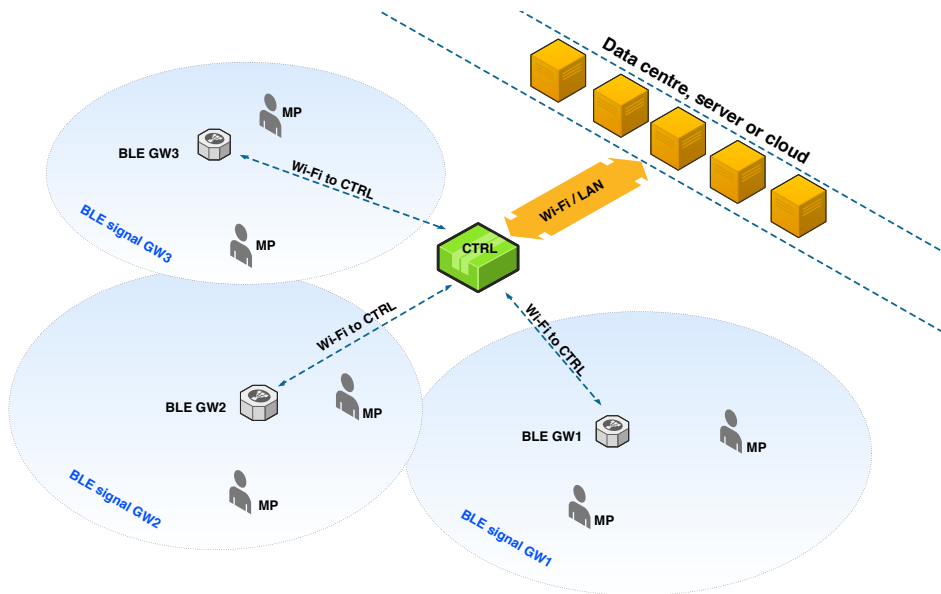

BLE signal - signal for connecting meters
BLEGW (1, 2, 3) - Bluetooth Gateway
MP - measuring workplace
CTRL - Kontrolér
BLEGW - Gateway transmits data to CTRL or directly to a Wi-Fi network ensures automatic connection of the meter; allows roaming, remote management
CTRL - Controller transfers data from BLEGW to applications, manages and configures all BLEGW universal output data formats, hosts applications such as SPC, etc., remote management

KINEX Measuring s.r.o.
 Podnikatelská 586, 190 11 Praha 9
 +420 724 486 318
 ispace@kinexmeasuring.com

EXISTING DOCUMENTATION

Use your drawings, control plans or other documents in paper or digital form.

DIGITIZATION OF WORKPLACE

We deliver wireless meters and digital infrastructure, integrate into your process.

SPC IN REAL TIME

Our SPC application creates control charts and histograms in real time or can integrate data directly into your existing system.

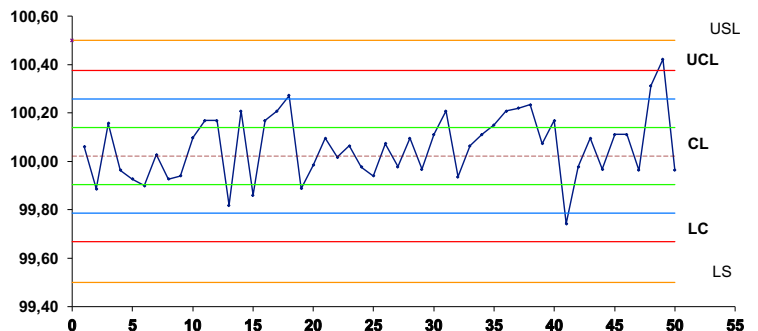

WWW.ICONIC-SPACE.COM

POMIAR BEZPRZEWODOWY



Iconic Space



PROSTA DYGTALIZACJA POMIARU W 3 KROKACH

BEZPRZEWODOWE URZĄDZENIA POMIAROWE

AUTOMATYCZNY ZBIÓR DANYCH

STATYSTYCZNA REGULACJA PROCESU

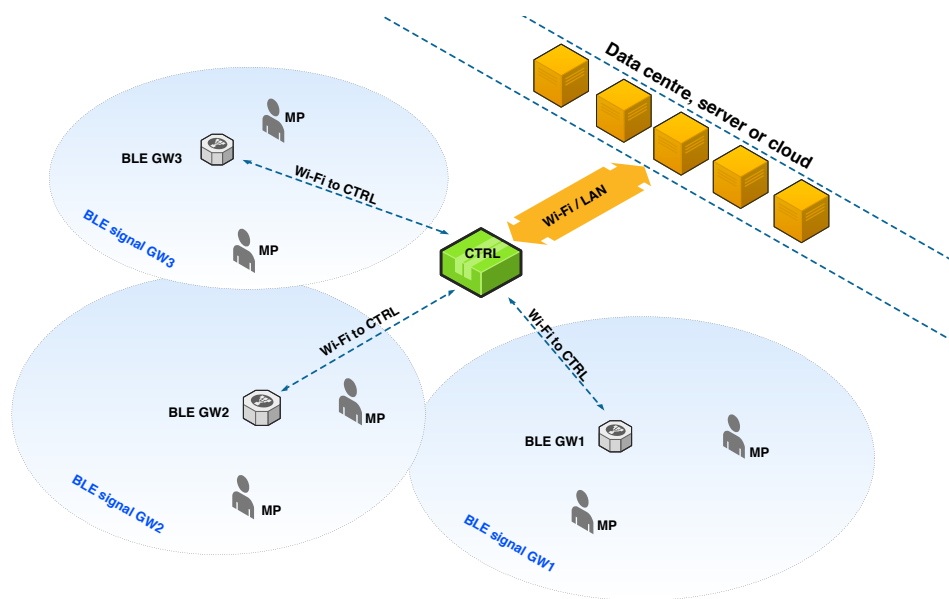

BLE sygnał - sygnał do podłączenia urządzeń
BLEGW (1, 2, 3) - Bluetooth Gateway
MP - miejsce pomiaru
CTRL - Kontroler
BLEGW - Gateway przesyła dane do CTRL lub bezpośrednio do sieci WiFi, zapewnia automatyczne połączenie urządzeń, umożliwia roaming, przesłanie danych
CTRL - Kontroler przesyła dane z BLEGW do aplikacji, kieruje i konfiguruje wszystkie BLEGW, uniwersalny format danych na wyjściu, jest hostem aplikacji jak np. SPC itd., przesyła dane

KINEX Measuring s.r.o.

Podkátelská 586, 190 11 Praha 9
 +420 724 486 318
 ispace@kinexmeasuring.com

DOTYCHCZASOWA DOKUMENTACJA

Wykorzystajcie Państwo dotychczasową dokumentację (wykres, plan kontrolny) w papierowej lub dygitalnej postaci.

DYGTALIZACJA MIEJSCA PRACY

Dostarczymy urządzenia do pomiaru bezprzewodowego oraz zainstalujemy infrastrukturę dygitalną.

SPC W CZASIE RZECZYWISTYM

Nasza aplikacja SPC wytworzy regulujące diagramy i histogramy w czasie rzeczywistym lub może integrować dane bezpośrednio do Waszego systemu

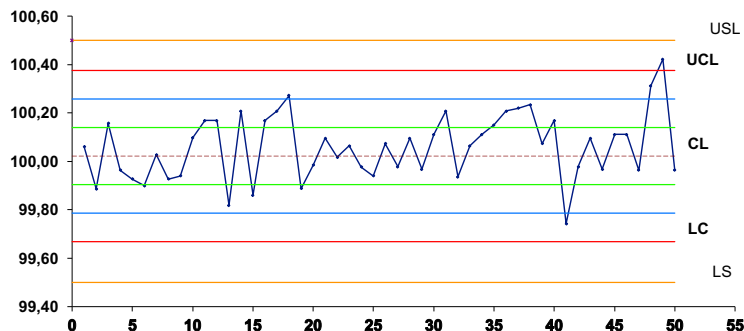



www.kinexmeasuring.com

