

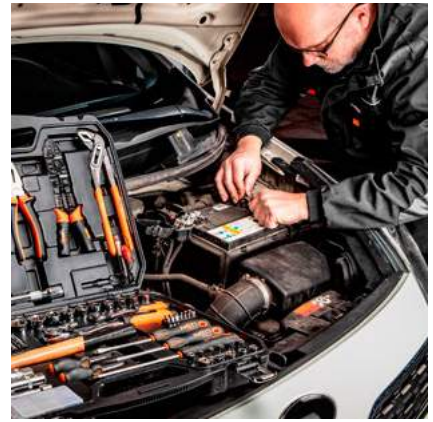

NARZĘDZIA RĘCZNE
HAND TOOLS РУЧНЫЕ ИНСТРУМЕНТЫ

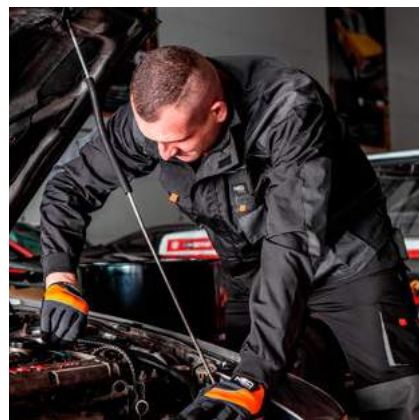

GRUPA
topex



Wielkość produktów w tym katalogu promują nasi pracownicy, bo Grupa TOPEX to przede wszystkim ludzie.

Most of the people, portrayed in the pictures in this catalogue, who are using our tools are the employees of the Grupa TOPEX, because we believe that our company is all about people.

Большинство продуктов в этом каталоге рекламируются нашими сотрудниками, потому что Grupa TOPEX – это в первую очередь люди.



Katalog narzędzi ręcznych 2021/2022 Catalogue of hand tools 2021/2022

Szanowni Państwo,

z dużą satysfakcją oddajemy w Państwa ręce nowe wydanie katalogu produktowego, zawierającego narzędzia ręczne. Głęboko wierzymy, że po raz kolejny spotka się on z Państwa uznaniem. Dołożyliśmy wszelkich starań, aby ta publikacja była przyjaznym i skutecznym narzędziem w Państwa rękach.

Z życzeniami powodzenia w biznesie,

Dear Customers,

It is with great satisfaction that we present to you the new edition of our product catalogue containing hand tools. We firmly believe that it will once again meet with your appreciation. We have done our best to make this publication a user-friendly and effective tool in your hands.

Good luck in business,

Piotr Potowski
Dyrektor Generalny
General Manager





Działamy na ponad 40 rynkach zagranicznych.

We operate on over 40 foreign markets.

Мы ведем деятельность на более чем 40 зарубежных рынках.

40

Klienci to siła napędowa naszej firmy.
Współpracujemy z 4000 partnerów handlowych na całym świecie.

Our customers drive the operations of our Company.
We cooperate with 4,000 business partners around the world.

Клиенты – это движущая сила нашей компании.
Мы сотрудничаем с 4000 коммерческими партнерами по всему миру.



4 000



7 200

Nasza oferta produktowa to ponad 7200 pozycji asortymentowych.

Our product portfolio covers over 7200 articles.

Наше предложение включает около 7200 ассортиментных позиций.

Zarządzamy portfelem 5 marek produktowych:
NEO TOOLS, GRAPHITE, VERTO, TOPEX, TOP TOOLS.

We manage a portfolio covering 5 product brands:
NEO TOOLS, GRAPHITE, VERTO, TOPEX, TOP TOOLS.

Мы управляем портфелем из 5 продуктовых брендов:
NEO TOOLS, GRAPHITE, VERTO, TOPEX, TOP TOOLS.





Nasz system zarządzania jakością w Dziale Technicznym posiada certyfikat zgodności z jedną z najważniejszych norm dotyczących kontroli jakości ISO 9001:2015.

Our Quality Management System implemented within the Technical Department has been certified as compliant with one of the most important standards pertaining to quality inspection, namely ISO 9001:2015.

Наша система менеджмента качества в Техническом отделе имеет сертификат соответствия одному из самых важных стандартов, касающихся контроля качества - ISO 9001:2015.

Wyróżnia nas jakość. Nasze laboratorium prowadzi ponad 100 różnych badań jakościowych opartych o Normy Europejskie dla około 300 grup produktowych.

Quality is what distinguishes us from others. Our laboratory carries out more than 100 different qualitative tests based on European standards, covering approximately 300 product groups.

Нас отличает качество. Наша лаборатория проводит свыше 100 различных исследований в соответствии с европейскими стандартами для ок. 300 групп продуктов.



Ponad 600 naszych pracowników dba o właściwy poziom obsługi naszych partnerów handlowych.

More than 600 of our employees care for the right level of our business partner service level.

Более 600 сотрудников заботятся о надлежащем уровне обслуживания наших коммерческих партнеров.

Biznes nie kończy się na realizacji zamówienia. Stałą dostępność części zamiennych do naszych produktów oraz profesjonalny serwis gwarancyjny i pogwarancyjny zapewnia GTX Service.

Business does not end with order fulfillment. Ongoing availability of spare parts for our products, and professional warranty and non-warranty services are provided by GTX Service.

Бизнес не заканчивается выполнением заказа. GTX Service обеспечивает постоянную доступность запасных частей к нашим продуктам а также профессиональное гарантийное и постгарантийное обслуживание GTX Service.



UŁATWIAMY ŻYCIE LUDZIOM, KTÓRZY UŻYWAJĄ NARZĘDZI.
WE MAKE LIFE EASIER FOR PEOPLE WHO USE TOOLS.
ОБЛЕГЧАЕМ ЖИЗНЬ ВСЕМ, КТО ПОЛЬЗУЕТСЯ ИНСТРУМЕНТОМ.

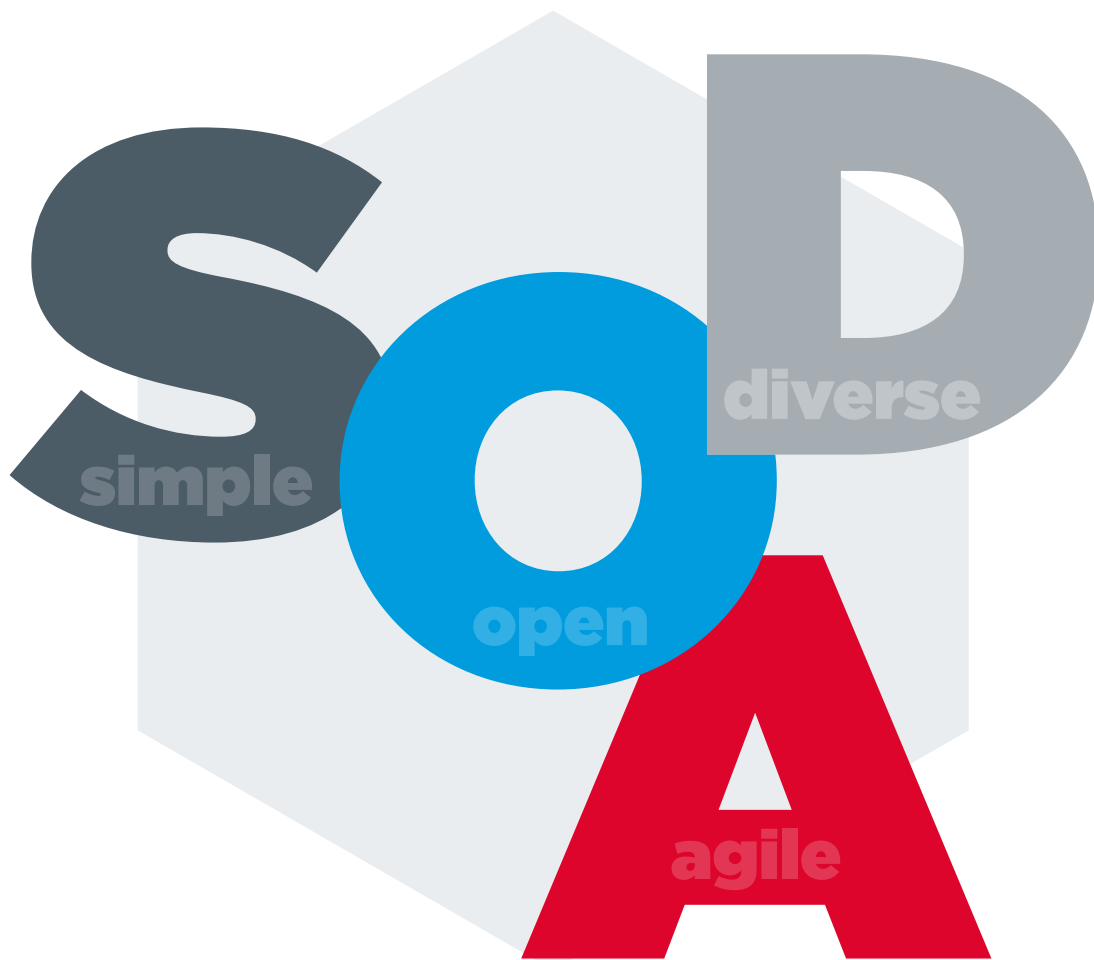

UPRASZCZANIE
SIMPLE
УПРОЩЕНИЕ

Maksymalne uproszczenie wszelkich podejmowanych działań poprzez kulturę poszukiwania prostszych rozwiązań.

Maximum simplification of any action taken through a culture of seeking simpler solutions and openness to a certain level of risk and imperfection.

Максимально упростить все предпринимаемые действия посредством культуры поиска самых простых решений.

OTWARTOŚĆ
OPEN
ОТКРЫТОСТЬ

Otwarta komunikacja budowana poprzez otwarty styl zarządzania, wspierana żywą kulturą informacji zwrotnej.

Open communication in the team built through an open management style, supported by a vibrant culture of feedback.

Открытая коммуникация, выстраиваемая благодаря открытому стилю управления и культуре качественной обратной связи.

RÓŻNORODNOŚĆ
DIVERSE
РАЗНООБРАЗИЕ

Zróżnicowanie pod każdym względem, zarówno w zakresie działań biznesowych jak i zespołu.

Diversity in every aspect, either in terms of business activities or team.

Дифференцированный подход, как в работе с бизнес-партнерами, так и внутри коллектива.

ELASTYCZNOŚĆ
AGILE
ЭЛАСТИЧНОСТЬ

Dostosowanie się do otoczenia i orientacja na faktyczne i aktualne potrzeby rynku.

Agile, adaptation to the environment and orientation to the current and actual market needs.

Подстраиваемся под окружение, ориентируемся на реальные и актуальные потребности рынка.

NOWY UKŁAD KATALOGU

Katalog główny narzędzi ręcznych 2021/2022 ułożony jest kategoriami produktowymi, pochodzącymi z naszych wszystkich marek, które obejmują narzędzia ręczne. Nowy układ stanowi odpowiedź na potrzeby Klientów. Celem takiego układu jest pokazanie przekrojowości asortymentu w ramach poszczególnych grup produktowych oraz ułatwienie nawigacji.

NEW PRODUCT ARRANGEMENT

The main catalog of hand tools 2021/2022 is arranged by product categories coming from all our brands which include hand tools. The new layout responds to the needs of customers. A purpose of such arrangements is to show the cross-sectional assortment and facilitating navigation.

НОВАЯ ВЕРСИЯ КАТАЛОГА

Основной каталог ручных инструментов на 2021/2022 гг. упорядочен по категориям продуктов всех наших марок, которые охватывают ручные инструменты. Новая версия отвечает потребностям клиентов. Цель этого каталога - показать пересечение ассортимента в рамках отдельных продуктовых групп для облегчения поиска.



NEO

TOOLS



25
years
GUARANTEE

TÜVRheinland
CERTIFIED

NEO TOOLS to...

- wysokiej klasy specjalistyczne i popularne narzędzia dla profesjonalistów, wymagających użytkowników oraz osób realizujących różne prace w domu
- w skład marki wchodzi wiele kategorii produktowych
- główne filary marki stanowi kategoria moto oraz BHP
- NEO Tools rozwija się również w zupełnie nowych obszarach, które idealnie wpisują się w męski świat
- marka pomaga realizować zarówno ciężkie zadania jak i swoje pasje
- w produkcji wykorzystane są najnowsze technologie i materiały
- 25 lat gwarancji* jakości i niezawodności

NEO TOOLS is...

- high-quality specialist and popular tools for professionals, demanding users and those who perform various works at home
- the brand includes many different product categories
- the main categories of the brand are Moto and OHS
- NEO Tools is also expanding in completely new areas that perfectly fit the male world
- the brand helps to perform both difficult tasks and fulfil one's passions
- in the production we use the latest technologies and materials
- 25 years of quality and reliability guarantee*

NEO TOOLS это...

- специализированные высококлассные и популярные инструменты для профессионалов, требовательных пользователей и мастеровых, которые выполняют домашнюю работу
- в состав марки входит множество товарных категорий
- в основе показателей марки лежат категории моторизации, безопасности и гигиены труда
- NEO Tools развивается также в совершенно новых сферах, которые идеально вписываются в мир мужчин
- марка помогает реализовывать как сложные задачи, так и свои увлечения
- в производстве используются новейшие технологии и материалы
- 25 лет гарантии* качества и надежности



neo-tools.com



@NEOTOOLS



Informacje o nowościach produktowych, wydarzeniach, konkursy, porady oraz video

Information about novelities, events, competitions, tips and videos

Информации о новых продуктах, событиях, конкурсы, советы и видео



@NEOTOOLSOFFICIAL



VIDEO produktowe, porównania i testy produktów w wielu wersjach językowych

Product related VIDEOS, product comparisons and tests in multiple language versions

ВИДЕО о продуктах, сравнение и тесты продуктов в различных языковых версиях



NEOmov





JAKOŚĆ

Najwyższa jakość materiałów i najnowocześniejsze rozwiązania technologiczne to kluczowe założenia standardów jakości NEO. Narzędzia NEO to ergonomiczne, precyzyjnie wykonane narzędzia stworzone do pracy w najcięższych warunkach. Produkty NEO testowane są zarówno w specjalistycznych laboratoriach jak i w miejscach pracy profesjonalistów.

QUALITY

High quality of materials and well proven technical solutions are the key foundations of the NEO quality standards. High quality and precision of workmanship make the NEO tools fit for use in the harshest conditions. NEO products are tested in specialised laboratories as well as in professionals' workplaces.

КАЧЕСТВО

Высокое качество материалов и проверенные технические решения являются ключевыми принципами стандартов качества NEO. Благодаря высокому качеству и точности исполнения инструменты NEO отлично проявляют себя в сложнейших рабочих условиях. Продукты NEO тестируются как в специализированных лабораториях, так и на местах работы профессионалов.

Laboratorium NEO Tools

Narzędzia NEO poddawane są specjalistycznym i rygorystycznym testom wytrzymałościowym. Badania jakościowe oparte są o normy europejskie. System zarządzania jakością w Dziale Technicznym posiada certyfikat zgodności z jedną z najważniejszych norm dotyczących kontroli jakości ISO 9001:2015.

NEO Tools laboratory

NEO tools undergo specialised and rigorous strength testing. Quality testing is based on European standards. The quality management system of the Technical Department is certified for compliance with one of the most important standards in the quality control field: ISO 9001:2015.

Лаборатория NEO Tools

Инструменты NEO подвергаются строгому специализированному тестированию на прочность. Проверка качества выполняется согласно европейским нормам. Система управления качеством в техническом отделе имеет сертификат соответствия одной из важнейших норм, касающихся контроля качества ISO 9001:2015





W procesie produkcji wykorzystywane są starannie wyselekcjonowane materiały, a jakość narzędzi jest stale weryfikowana w trakcie rygorystycznych procedur kontrolnych. Produkty NEO spełniają najwyższe kryteria jakościowe, czego znakiem jest 25-letni okres ochrony gwarancyjnej na narzędzia mechaniczne NEO.

Manufacturing process uses carefully selected materials, and the tool quality is constantly verified with rigorous control procedures. NEO products meet the highest quality criteria, which is confirmed with 25 years warranty for NEO mechanical tools.

В процессе производства используются старательно отобранные материалы, а качество инструментов постоянно верифицируется в ходе строгих контрольных процедур. Продукты NEO отвечают наивысшим критериям качества, что подтверждает 25-летняя гарантия на механические инструменты NEO.

Narzędzia NEO cieszą się zaufaniem wymagających użytkowników oraz profesjonalistów, którzy poszukują rozwiązań na najwyższym poziomie. O niezawodności i uznaniu ze strony środowiska biznesowego świadczą liczne wyróżnienia. Najważniejszym z nich jest międzynarodowy certyfikat TÜV, który jest jednym z najbardziej rozpoznawalnych znaków jakości na świecie.

NEO tools earned trust of demanding users and professionals who search for solutions of the highest standards. Reliability and recognition in the business sector are confirmed with numerous prizes and distinctions. The most important of all is the international TÜV certificate, one of the most recognised quality marks in the world.

Инструменты NEO пользуются доверием требовательных пользователей и профессионалов, ищущих решений на наивысшем уровне. О надежности и признании со стороны профессионального сообщества свидетельствуют многочисленные знаки отличия. Важнейший из них - международный сертификат TÜV, являющийся одним из наиболее узнаваемых знаков качества в мире.



TESTOWANIE NARZĘDZI

Narzędzia mechaniczne i warsztatowe marki NEO Tools są testowane nie tylko w naszych laboratoriach, ale przede wszystkim w realnych warunkach pracy. Nasze narzędzia zanim wejdą na rynek używane są w profesjonalnym warsztacie mechanicznym NEO Garage.

Mechanicy NEO Garage, wykonując codzienne prace warsztatowe takie jak:

- **przeeglądy okresowe**
- **naprawy silników, zawieszzeń, układów hamulcowych i kierowniczych, itd.**
- **renowacje samochodów zabytkowych**

dostarczają informacji zwrotnych pozwalających ulepszać nasze narzędzia.

Dzięki temu możemy zaoferować Państwu najwyższej jakości produkty przeznaczone do pracy w branży motoryzacyjnej.

Zachęcamy do dokładnej analizy katalogu i zaopatrzenia swoich firm w narzędzia mechaniczne i warsztatowe marki NEO Tools.

TOOL TESTING

Mechanical and workshop NEO Tools are tested not only in our laboratories, but above all in real working conditions. Before introduction to the market, our tools are used in professional mechanical workshop NEO Garage.

Mechanical engineers of NEO Garage perform everyday workshop tasks, such as:

- **periodic inspections**
- **repairs of engines, suspensions, braking and steering systems, etc.**
- **renovations of antique vehicles**

and they can deliver feedback so we can improve our tools.

This allows us to offer products of the highest quality designed for automotive field.

Please see our catalogue in detail and supply your company with NEO Tools for mechanical and workshop use.

ТЕСТИРОВАНИЕ ИНСТРУМЕНТА

Механические инструменты, а также инструменты для СТО марки NEO Tools проходят испытания не только в наших лабораториях, но, прежде всего, в реальных условиях работы. Наши инструменты, прежде чем выйти на рынок, используются в профессиональной механической СТО NEO Garage.

Механики NEO Garage, выполняя ежедневные работы в СТО, такие как:

- **регламентные технические осмотры**
- **ремонт двигателей, подвесок, тормозных и рулевых систем и т.д.**
- **восстановление и ремонт исторических автомобилей**

обеспечивают обратную связь, позволяющую улучшить наши инструменты.

Благодаря этому мы можем предложить вам продукцию высочайшего качества, предназначенную для работы в автомобильной промышленности.

Мы рекомендуем вам тщательно проанализировать каталог и обеспечить свои компании механическими инструментами, а также инструментами для СТО марки NEO Tools.

NEO

GARAGE



neogarage.pl

NEO

GARAGE

neogarage.pl

GARAŻ GARAGE ГАРАЖ

Pełen zakres usług naprawy pojazdów: przeglądy okresowe, wymiany eksploatacyjne, remonty jednostek napędowych i innych układów mechanicznych, projekty renowacji.

Full range of vehicle repair services: periodic inspections, replacement of consumables, overhauls of drive units and other mechanical systems, projects of renovation.

Полный объем услуг по ремонту автомобилей: периодическое тех. обслуживание, сервисное обслуживание, ремонты приводов и прочих механических систем, проекты по реновации.



WARSZTAT MECHANICZNY MECHANICAL WORKSHOP МЕХАНИЧЕСКАЯ МАСТЕРСКАЯ

Rozbudowana i dopasowana do potrzeb użytkowników oferta garażowania różnego typu pojazdów.

Offer of storage for various types of vehicles is well developed and meets the needs of users.

Широкий, учитывающий потребности потребителей ассортимент для обслуживания автомобилей разного типа.

STANOWISKA SAMOOBŚLUGOWE SELF SERVICE STATIONS СТАНЦИИ САМООБСЛУЖИВАНИЯ

Możliwość samodzielnej naprawy i konserwacji pojazdów. Udostępnione wszystkie niezbędne narzędzia oraz myjnia i stanowiska do auto-detailingu.

Users can repair and maintain their own vehicles by themselves. All necessary tools, car wash and stations for car detailing are available.

Возможность самостоятельного ремонта и технического обслуживания автомобилей. Предоставление всего необходимого инструмента, а также автомойка и центры детейлинга.



SALA KONFERENCYJNA CONFERENCE ROOM КОНФЕРЕНЦ-ЗАЛ

Możliwość organizacji spotkań biznesowych w wyjątkowym otoczeniu.

Exceptional environment for business meetings.

Возможность организации бизнес-встреч в уникальном месте.



TOPEX to:

- to jedna z najbardziej rozpoznawalnych marek narzędzi ręcznych w Polsce
- szeroki asortyment solidnie wykonanych narzędzi w atrakcyjnej cenie
- produkty ogólnie dostępne i niezbędne w każdym domu

TOPEX is:

- one of the best recognised hand tool brands in Poland
- a wide range of sturdy design tools at attractive prices
- products easily available and indispensable at every home

TOPEX это:

- одна из самых узнаваемых марок ручных инструментов в Польше
- широкое предложение надежного инструмента по привлекательной цене
- доступный инструмент, необходимый в каждом доме





Zapraszamy na kanały marki TOPEX w mediach społecznościowych

Come and browse TOPEX social media channels

Приглашаем на каналы марки TOPEX в социальных сетях



Sprytny.TOPEX



Informacje o nowościach produktowych, porady oraz VIDEO

Information on new products, advice and VIDEOS

Информация о новых продуктах, советы и ВИДЕО



TOPEXmov



VIDEO produktowe, porównania i testy produktów w wielu wersjach językowych

Product related VIDEOS, product comparisons and tests in multiple language versions

ВИДЕО о продуктах, сравнение и тесты продуктов в различных языковых версиях



TOPEX



TOP TOOLS

RAZ, DWA ... I PO SPRAWIE

TOP TOOLS to...

- gama podstawowych narzędzi ręcznych oraz klódek
- produkty w bardzo atrakcyjnych cenach do stosowania przy prostych pracach domowych

TOP TOOLS means...

- a range of basic hand tools and padlocks
- products at very attractive prices for use in simple housework

TOP TOOLS – это...

- гамма основного ручного инструмента и навесных замков
- продукты предназначенные для несложных домашних работ по очень привлекательным ценам

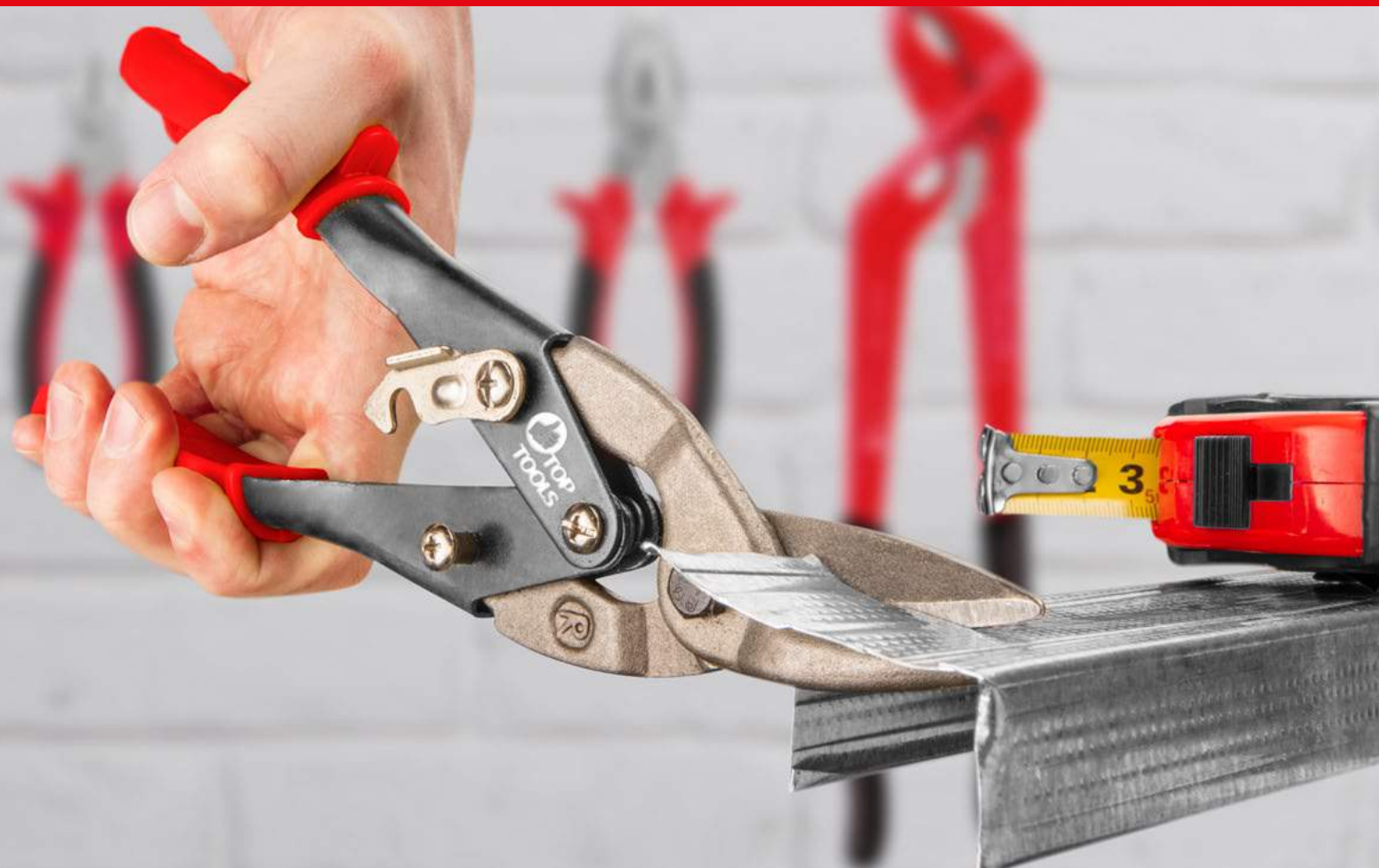



VERTO



JEST TYLE DO ZROBIENIA
THERE IS SO MUCH TO DO
ТАК МНОГО НУЖНО СДЕЛАТЬ ДЕЛ

VERTO to:

- szeroka gama **narzędzi ogrodowych**, elektronarzędzi oraz akcesoriów do elektronarzędzi
- wszechstronne, wygodne w obsłudze rozwiązania w bardzo dobrej relacji jakości do ceny
- produkty idealnie sprawdzające się przy średnich obciążeniach

VERTO is:

- a wide range of **garden** and workshop tools, power tools and accessories
- versatile, convenient solutions with very good quality to price ratio
- products perfectly fit to moderate load

VERTO – это

- широкая гамма **садового инструмента**, электроинструмента и аксессуаров
- комплексные, удобные в эксплуатации решения в хорошем соотношении цена-качество
- товары, идеально подходящие для выполнения работ средней тяжести



VERTOTOOLS



Informacje o nowościach produktowych, porady oraz VIDEO

Information on new products, advice and VIDEOS

Информация о новых продуктах, советы и ВИДЕО



VERTOTOOLS



VIDEO produktowe, porównania i testy produktów w wielu wersjach językowych

Product related VIDEOS, product comparisons and tests in multiple language versions

ВИДЕО о продуктах, сравнение и тесты продуктов в различных языковых версиях

Nasze wieloletnie doświadczenie i znajomość rynku elektronarzędzi pomogła nam w opracowaniu rozwiązań ekspozycji produktów, które wspierają naszych partnerów handlowych w codziennym biznesie.

- **unikalność** - regały dedykowane dla marki NEO Tools, Topex, Verto
- **solidność** - konstrukcje wykonane z dobrej jakości materiałów
- **nowoczesność** - ciekawe rozwiązanie na komunikację o produktach, markach, akcjach promocyjnych
- **uniwersalność** – odpowiednie dopasowanie do ilości miejsca w sklepie

Many years of experience and knowledge of tool market allowed us to develop solutions for product exposition, which create a great support in everyday business for our trade partners.

- **unique features** – cabinets dedicated for NEO Tools, Topex, Verto brands
- **reliability** – designs include good quality materials
- **modern design** – interesting solution for communication about products, brands, promotional events
- **versatility** – matching to space available in a shop

Благодаря нашему многолетнему опыту и знанию рынка инструмента, мы разработали решения по эффективной презентации товаров, которые помогают нашим коммерческим партнерам в их повседневной работе

- **уникальность** – стеллажи, предназначенные для брендов NEO Tools, Topex, Verto
- **прочность** – конструкции изготовлены из материалов хорошего качества
- **современность** – интересные решения по маркетинговой коммуникации - о товарах, брендах, промо-акциях
- **универсальность** – специальные решения с учетом площади магазина

NEO
TOOLS

TOPEX

VERTO

TOP TOOLS



OFERTA SZYTA NA MIARĘ
TAILORED-MADE OFFER
ОФЕРТА ПОД ЗАКАЗ

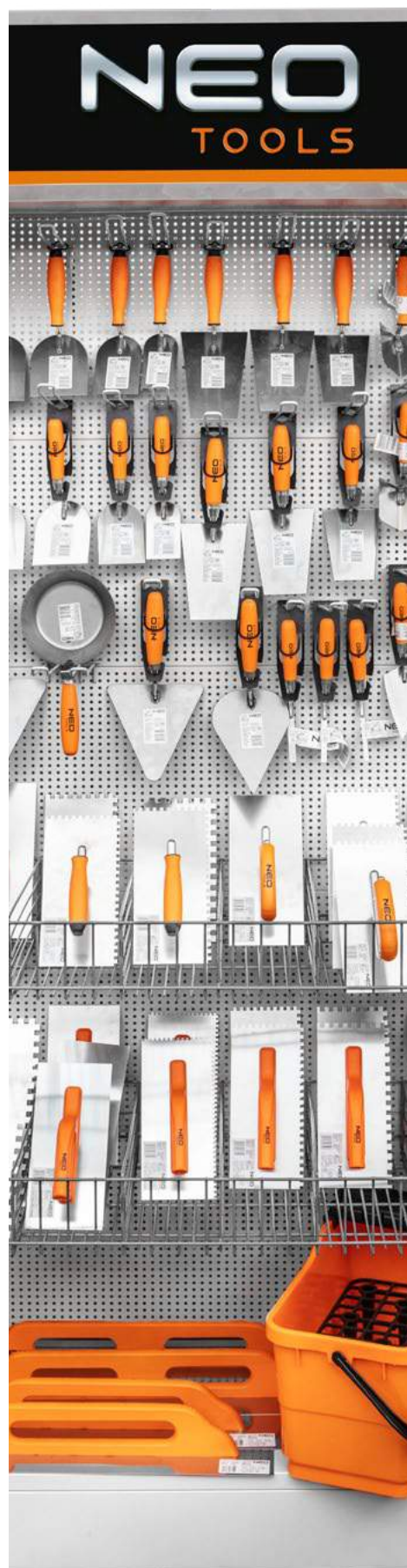



POLISH DRILLS
 **since 1908**



**Wiertła
Baidon**



Ponad wiek doświadczeń w produkcji wiertel daje gwarancję skuteczności naszego działania i zadowolenia klientów.

Over a century of experience in drills' manufacture guarantees our excellence and satisfaction of our customers.

Более века опыта в производстве сверл гарантирует эффективность нашей деятельности и удовлетворенность клиентов

- szeroki **asortyment** narzędzi specjalnych - **50 rodzajów wiertel, 16 000 typowymiarów**
- możliwość wykonania **wiertel zgodnie z dostarczoną dokumentacją techniczną** klienta
- profesjonalne doradztwo techniczne w zakresie **optymalizacji procesu obróbki skrawaniem**
- a wide **assortment** of special tools - **50 drill bit types, 16 000 type dimensions**
- customized **drill bits manufactured according to your technical documentation**
- professional technical **consultancy to streamline your machining processes**
- **широкий ассортимент** специальных инструментов - **50 видов сверл, 16 000 типоразмеров**
- возможность **изготовления сверл в соответствии с предоставленной технической документацией** клиента
- профессиональные технические консультации по **оптимизации процесса обработки резанием**



Dlaczego my? Why us? Почему мы?

- **WŁASNA PRODUKCJA**
dostosowana do oczekiwań i wymagań klienta
- **WYSOKA JAKOŚĆ**
potwierdzona certyfikatami
- **SZEROKI ASORTYMENT**
- **DOGODNE TERMINY**
realizacji zamówień
- **FACHOWE DORADZTWO**

- **IN-HOUSE PRODUCTION**
adapted to your needs and expectations
- **HIGH QUALITY**
confirmed by certificates
- **WIDE ASSORTMENT**
- **SHORT**
completion dates
- **EXPERT CONSULTANCY**

- **СОБСТВЕННОЕ ПРОИЗВОДСТВО**
адаптированное к ожиданиям и требованиям клиента
- **ВЫСОКОЕ КАЧЕСТВО**
подтвержденное сертификатами
- **ШИРОКИЙ АССОРТИМЕНТ**
- **УДОБНЫЕ СРОКИ**
выполнения заказов
- **ПРОФЕССИОНАЛЬНЫЕ КОНСУЛЬТАЦИИ**

SPIS TREŚCI OBRAZKOWY

PICTURE LIST

СОДЕРЖАНИЕ В ИЛЛЮСТРАЦИЯХ

SZCZYPCY

PLIERS

ЩИПЦЫ

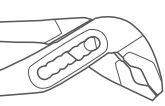

27



34



35



35



36



37



38



42



43



45

KLUCZE I WKREŃAKI

WRENCHES

AND SCREWDRIVERS

КЛЮЧИ И ОТВЕРТКИ



48



49



52



53



57



61



84



90



98



109



113

MOTORYZACYJNE

AUTOMOTIVE TOOLS

АВТОМАСТЕРСКОЕ

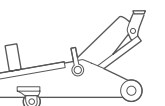

128



141



143



146



147



149



150



155



159



161



166

PNEUMATYKA

PNEUMATICS

ПРЕВМАТИЧЕСКИЙ

ИНСТРУМЕНТ

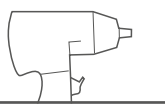

170



174



175



176



178

SPIS TREŚCI OBRAZKOWY

PICTURE LIST

СОДЕРЖАНИЕ В ИЛЛЮСТРАЦИЯХ

BHP
OHS
СИЗ



181



191



197



200



204



205



206



212



213



214



216

BUDOWLANE
BUILDING
СТРОИТЕЛЬНЫЕ

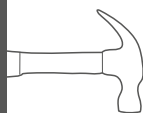

220



227



235



239



242



244



251

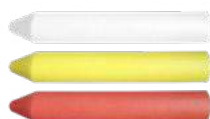

254



256



258



259

POMIAROWE
MEASURING
ИЗМЕРИТЕЛЬНЫЕ

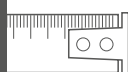

264



257



270



273



276

TRANSPORT
TRANSPORTATION
ТРАНСПОРТИРОВКА

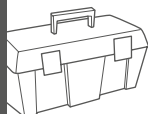

278



286



296



299



301

ŁĄCZĄCE
JOINING
СОЕДИНИТЕЛЬНЫЕ

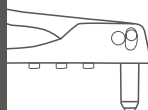

304



306



307



310



315

SPIS TREŚCI OBRAZKOWY

PICTURE LIST

СОДЕРЖАНИЕ В ИЛЛЮСТРАЦИЯХ

DEKORATORSKIE DECORATING ОТДЕЛОЧНЫЕ



318



324



325



326



331

OSWIETLENIE WORKSHOP LIGHTING ОСВЕЩЕНИЕ

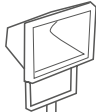

334



335



337



338



340

SURVIVAL SURVIVAL ВЫЖИВАНИЕ



342



343



344



345



347

DOM I GARAŻ HOUSE AND GARAGE ДОМ И ГАРАЖ

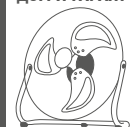

350



351



352

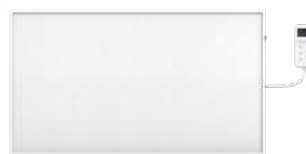

354



355

OGRÓD GARDEN САД И ОГОРОД

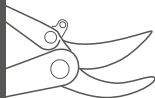

358



365



367



368



369



371



371



372



373



375



378



379



379

ZABEZPIECZENIA PROTECTION БЕЗОПАСНОСТЬ



381



382



SZCZYPCE
PLIERS ЩИПЦЫ



Szczypce uniwersalne

Combination pliers / Kombizange / Пассатижи / Пасатижи / Kombinált fogó / Clește universal / Kombinované kleště / Kliešte kombinované / Kombinirane klešče / Universalis replės / Plakanknaibles kombinētās / Universaalnāpitsad / Клещи комбинирани / Kombinirana klijesta / Kombinovana klesta / Πένσα γενικής χρήσης / Alicates universales / Pinza universale / Pinças universais / Pince universelle / Universele tang

NEO
TOOLS

25
years
GUARANTEE

TÜV Rheinland
CERTIFIED

55-60
HRC

DIN
5746

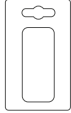

Ref.	L[mm]	☒	EAN
01-010	160	6/48	5907558401547
01-011	180	6/48	5907558401554
01-012	200	6/48	5907558401561

NEO
TOOLS



SOFT
handle

TPR
ABS

HARDENED

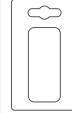

Ref.	L[mm]	☒	EAN
01-250	160	6/60	5907558443646
01-251	180	6/60	5907558443653

NEO
TOOLS

40%
FORCE
SAVE

HIGH
LEVERAGE

MORE USES

CrNi
steel

POWER
PLIERS

58-64
HRC

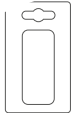

Ref.	L[mm]	☒	EAN
01-152	180	6/48	5907558448511
01-153	200	6/48	5907558448528

TOPEX



Ergo
design

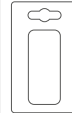

Ref.	L[mm]	☒	EAN
32D122	160	6/60	5902062011619
32D123	180	6/60	5902062011626
32D124	200	6/60	5902062011633

TOPEX

CARBON
STEEL

Ergo
design

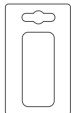

Ref.	L[mm]	☒	EAN
32D098	160	6/60	5902062320988
32D099	180	6/48	5902062320995
32D100	200	6/60	5902062321008

TOP TOOLS

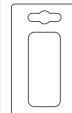

Ref.	L[mm]	☒	EAN
32D110	160	6/60	5902062010025
32D111	180	6/60	5902062010032
32D112	200	6/60	5902062010049

Szczypce wydłużone proste

Combination pliers / Kombizange / Пассатижи / Пасатижи / Hosszúcsőrű fogó / Clește universal / Kombinované kleště / Kliešte kombinované / Kombinirane klešče / Universalis replės / Plakanknaibles kombinētās / Universaalnāpitsad / Клещи комбинирани / Kombinirana klijesta / Kombinovana klesta / Πένσα γενικής χρήσης / Alicates universales / Pinza a becco lungo / Pinças retas prolongadas / Pince allongée droite / Lange rechte tang

NEO
TOOLS

25
years
GUARANTEE

TÜV Rheinland
CERTIFIED

55-60
HRC

DIN
5745

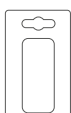

Ref.	L[mm]	☒	EAN
01-013	160	6/48	5907558401578
01-014	200	6/48	5907558401585

NEO
TOOLS

SOFT
handle

TPR
ABS

HARDENED

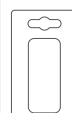

Ref.	L[mm]	☒	EAN
01-252	160	6/60	5907558443660
01-253	180	6/60	5907558443677

Szczypce wydłużone proste

Combination pliers / Kombizange / Пассажирские / Пассажирские / Hosszúcsőrű fogó / Clește universal / Kombinované kleště / Kliešte kombinované / Kombinirane klešče / Universālos replēs / Plakanknaibles kombinētās / Universālnāpītsad / Клеши комбинирани / Kombinirana klijesta / Kombinovana klesta / Πένσα γενικής χρήσης / Alicates universales / Pinza a becco lungo / Pinças retas prolongadas / Pince allongée droite / Lange rechte tang

NEO
TOOLS



Ref.	L[mm]	⊠	EAN
01-154	160	6/48	5907558448535
01-155	200	6/48	5907558448542

TOPEX

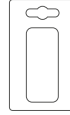

Ref.	L[mm]	⊠	EAN
32D101	160	6/60	5902062321015

TOPEX



Ref.	L[mm]	⊠	EAN
32D125	160	6/60	5902062011664

TOP TOOLS

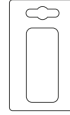

Ref.	L[mm]	⊠	EAN
32D113	160	12/120	5902062010056
32D115	200	6/60	5902062010063

Szczypce wydłużone wygięte

Long nose bent pliers / Zange lang, gebogen / Плоскогубцы удлиненные изогнутые / Щипцы видовожени, вигнуты / Rövidcsőrű fogó / Clește varf ascuțit indoit / Kleště prodloužené vyhnuté / Kliešte predĺžené vyhnuté / Koničaste klešče - upognjene / Prailgintos replēs, lenktos / Izliektas pagarinātas knaibles / Pikkade kõverate otslega näpitsad / Клеши удължени огънати / Izdužena savinuta klijesta / Izdužena uvijena klešta / Μυτοτσάμπιδο κυρτό / Alicate Teléfono curvo / Pinza a becco curvo / Pinças curvadas prolongadas / Pince allongée coudées / Lange gebogen tang

NEO
TOOLS

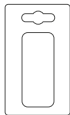
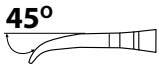

Ref.	L[mm]	⊠	EAN
01-015	160	6/48	5907558401592
01-016	200	6/48	5907558401608

NEO
TOOLS

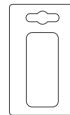
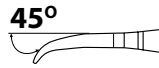

Ref.	L[mm]	⊠	EAN
01-254	160	6/60	5907558443684
01-255	180	6/60	5907558443691

TOPEX

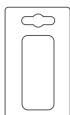

Ref.	L[mm]	⊠	EAN
32D103	160	6/60	5902062321039

TOP TOOLS

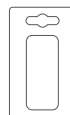
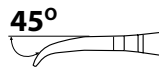

Ref.	L[mm]	⊠	EAN
32D114	160	12/120	5902062010070
32D116	200	6/60	5902062010087

Szczypce boczne

Diagonal cutting pliers / Seitenzange / Бокорезы / Бокорізи / Oldalcsípő fogó / Clește ascuțit diagonal de tăiat sîrmă / Bočni kleště / Cvikačky bočné / Stranske klešče / Šoninés replés / Sänknaibles / Diagonaal-löiketangid / Клеци Резачки / Klijesta cvikerice / Klesta poluokrugla / Πλαγιόκοφτες / Alicates diagonales / Tronchese laterale / Pinças laterais / Pince latérale / Zijtang

NEO
TOOLS



NEO
TOOLS



Ref.	L[mm]	⊠	EAN
01-017	160	6/48	5907558401615
01-018	180	6/48	5907558401622



Ref.	L[mm]	⊠	EAN
01-256	160	6/60	5907558443707
01-257	180	6/60	5907558443714

NEO
TOOLS



NEO
TOOLS



Ref.	L[mm]	⊠	EAN
01-156	160	6/48	5907558448559
01-157	180	6/48	5907558448566



Ref.	L[mm]	⊠	EAN
01-158	180	6/48	5907558448573

TOPEX



Ref.	L[mm]	⊠	EAN
32D106	160	6/60	5902062321060
32D107	180	6/60	5902062321077

TOPEX



Ref.	L[mm]	⊠	EAN
32D126	160	6/60	5902062011640
32D127	180	6/60	5902062011657

TOPEX



Ref.	L[mm]	⊠	EAN
32D138	180	6/48	5902062011701

TOP TOOLS



Ref.	L[mm]	⊠	EAN
32D118	160	6/60	5902062010100
32D119	180	6/60	5902062010650

Szczypce do izolacji

Wire stripper / Isolierungszange / Бокорезы для зачистки / Бокорізи для зачищування / Kábelcsúszoló / Clește p/înlăturarea izolatorului / Kleště na izolaci / Klijeste odizolovacie / Klešče za snemanje izolacije / Replés izolációjai / Knaibles izolácijs / Kaablitangid / Клеци Загопвачки за монтаж / Klesta za izolaciju / Απογυμνωτές καλωδίων / Alicates pelacables / Pinza spela fili regolabile 1000V / Pinças p. Isolação / Pince à dénuder / Isolatielang

TOPEX

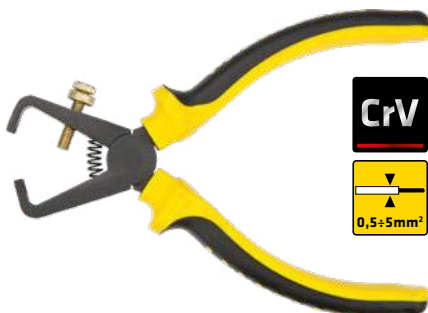

Ref.	L[mm]	⊠	EAN
32D407	160	6/96	5902062011718

TOP TOOLS



Ref.	L[mm]	⊠	EAN
32D401	160	6/96	5902062010018

Szczypce okrągłe

Round nose pliers / Rundzange / Κρηλοζυβίς / Κρηλοζυβίς / Kerekcsőrű fogó / Clește rotund / Kulaté kleště / Kliešte s okrúhlou čelustou / Okrągłe kleście / Αρναίος replēs / Αρναίκαίβλες / Útarmokk-nápisad / Клеици Чоуки / Klijesta okrugla / Klesta okrugla / Μυτοστάμιοδο με στρογγυλά ράμφη / Alicates redondos / Pinza a becco tondo / Pinças redondas / Pince ronde / Ronde tang

NEO
TOOLS

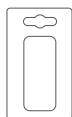

Ref.	L[mm]	⊠	EAN
01-020	160	6/48	5907558401646

Szczypce płaskie

Flat nose pliers / Zange flach / Плоскозубицы / Щипцы з плоскими зубками / Laposcsőrű fogó / Clește varf plat / Kleště ploché / Kliešte ploché / Ploščate kleście / Plošččios replēs / Plakanas knaibles / Lamenápisad / Плоски клеици / Plosnata klijesta / Ravna klešta / Πέννα / Alicate Boca plana / Pinza a becco piatto / Pinças planas / Pince à fourches / Vlakke tang

NEO
TOOLS

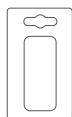

Ref.	L[mm]	⊠	EAN
01-019	160	6/48	5907558401639

TOPEX

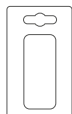

Ref.	L[mm]	⊠	EAN
32D109	160	6/60	5902062321091

TOPEX

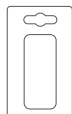
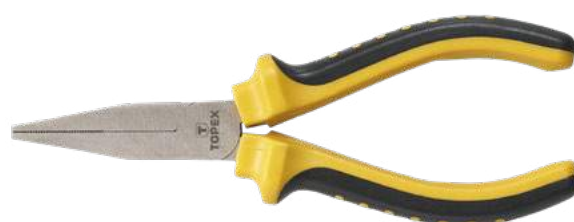

Ref.	L[mm]	⊠	EAN
32D108	160	6/60	5902062321084

TOP TOOLS

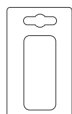

Ref.	L[mm]	⊠	EAN
32D121	160	6/60	5902062010124

TOP TOOLS

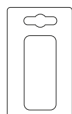

Ref.	L[mm]	⊠	EAN
32D120	160	12/120	5902062010117

Szczypce precyzyjne uniwersalne

Precision combination pliers / Allzweck-Feinzange / Плоскозубицы прецизионные комбинированные / Кусачки прецизійні універсальні / Preciós kombinált fogó / Clește combinat, precizie / Kleště precizní univerzální / Kliešte precízne univerzálne / Univerzalne precízne kleście / Replēs precizinēs, universalios / Universálas precizējošas knaibles / Universaalsed peennápisad / Универсални прецизни клеици / Univerzalna precizna klijesta / Univerzalna precizna klešta / Πέννα ακριβείας γενικής χρήσης / Alicates universales de precisión / Pinza universale di precisione / Pinças precisas universais / Pince de précision universelle / Precisie universele tang

TOPEX



TOPEX

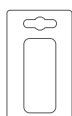

Ref.	L[mm]	⊠	EAN
32D030	120	10/100	5902062009708

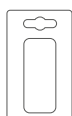

Ref.	L[mm]	⊠	EAN
32D721	115	10/100	5902062132017

TOP TOOLS

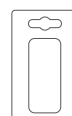

Ref.	L[mm]	⊠	EAN
32D164	120	10/100	5902062035684

Szczypce precyzyjne wydłużone proste

Precise long nose straight pliers / Feinzange, lang, gerade / Плоскогубцы прецизионные удлиненные / Щипці прецизійні, з видовженими, прямими губками / Hosszúcsőrű fogó / Cleste precizie-varf lung / Kleště precizní prodloužené rovné / Kliešte precízne predĺžené rovné / Precizne ravne podaljšane klešče / Prailgintos precizinės replės, tiesios / Pagarinātas precizējošas plakanknaibles / Pikkade otstega peennäpitsad / Прецизни удължени клещи / Precizna izdužena jednostavna klijesta / Precizna ravna izdužena klešta / Μυτσογιάνιο ακριβείας / Alicates puntas redondas larga / Pinza di precisione a becco lungo / Pinças precisas prolongadas retas / Pince de précision allongée droite / Lange rechte precisie tang

NEO
TOOLS



Ref.	L[mm]	⊠	EAN
01-102	130	6/96	5907558401684

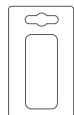

TOPEX



Ref.	L[mm]	⊠	EAN
32D726	130	10/100	5902062132062

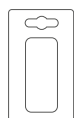

TOPEX



Ref.	L[mm]	⊠	EAN
32D032	125	10/100	5902062009722

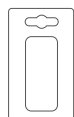

TOPEX



Ref.	L[mm]	⊠	EAN
32D036	150	10/100	5902062009760

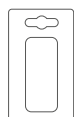

TOP TOOLS



Ref.	L[mm]	⊠	EAN
32D163	125	10/100	5902062035677
32D161	150	10/100	5902062035653

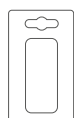

Szczypce precyzyjne wydłużone wygięte

Precise long nose bent pliers / Feinzange, lang, gebogen / Плоскогубцы прецизионные удлиненные изогнутые / Щипці прецизійні, з видовженими, вигнутими губками / Rövidcsőrű fogó / Cleste precizie-varf indoit / Kleště precizní prodloužení vyhnuté / Kliešte precízne predĺžené vyhnuté / Precizne podaljšane upognjene klešče / Prailgintos precizinės replės, tiesios / Izliektas pagarinātas precizējošas plakanknaibles / Pikkade kõverate otstega peennäpitsad / Прецизни удължени огънати клещи / Precizna izvijena izdužena klešta / Μυτσογιάνιο ακριβείας κούρτό / Alicates puntas curvas larga / Pinza di precisione a becco curvo / Pinças precisas prolongadas curvadas / Pince de précision allongée coudées / Lange gebogen precisie tang

NEO
TOOLS



Ref.	L[mm]	⊠	EAN
01-103	140	6/96	5907558401691

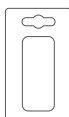

TOPEX



Ref.	L[mm]	⊠	EAN
32D033	125	10/100	5902062009739

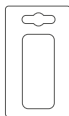

TOPEX



Ref.	L[mm]	⊠	EAN
32D723	130	10/100	5902062132031

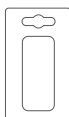

TOP TOOLS

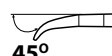

Ref.	L[mm]	⊠	EAN
32D166	125	10/100	5902062035707

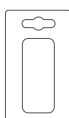

Szczypce precyzyjne boczne

Precision diagonal pliers / Seitenpräzisionszange / Бокорезы прецизионные / Плоскозубці прецизійні діагональні / Oldalcsipő fogó / Clește diagonal / Kleště boční jemná mechanika / Cvikáčky bočné mikro / Čelne kleště, precizne / Šoninēs replēs tikslīems darbams / Sānknaibles / Diagonaal-tāppisnāpitsad / Клеци резачки / Klijēšta cvikerice / Klesta secice / Πλαγιοκόφτης ακριβείας / Alicates diagonales de precisión / Tranchese laterale di precisione / Pinças precisas laterais / Pince de précision latérale / Precisie zijtang

NEO
TOOLS



Ref.	L[mm]	⊠	EAN
01-106	110	6/96	5907558401721

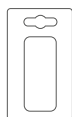

T TOPEX



Ref.	L[mm]	⊠	EAN
32D031	113	10/100	5902062009715

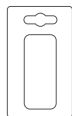

T TOPEX

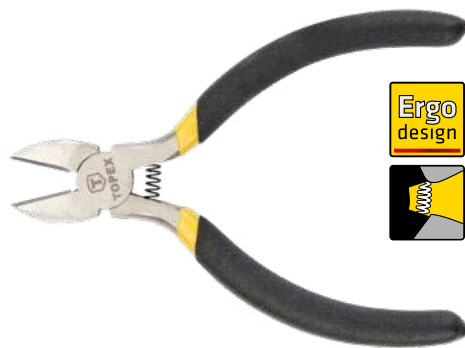

Ref.	L[mm]	⊠	EAN
32D724	115	10/100	5902062132048

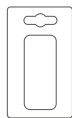

TOP TOOLS



Ref.	L[mm]	⊠	EAN
32D160	113	10/100	5902062035646

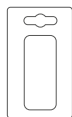

NEO
TOOLS



Ref.	L[mm]	⊠	EAN
01-509	140	10/50	5907558439281

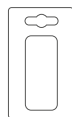

Szczypce precyzyjne czółowe

Precision end cutter pliers / Stirpräzisionszange / Кусачки торцевые прецизионные / Бокорезы прецизійні / Homlokcsipő fogó / Clește frontal / Kleště čelní jemná mechanika / Cvikáčky čelné mikro / Stranske kleště, precizne / Zņuplēs tikslīems darbams / Knaibles / Tāppisnāpitsad otste lōikamīseks / Клеци резачки / Klijēšta cvikerice / Klesta secice / Εμπροσθοκόφτης ακριβείας / Alicates frontales de precisión / Tenaglia di precisione / Pinças precisas frontais / Pince de précision frontale / Precisie hoofdtang

NEO
TOOLS



Ref.	L[mm]	⊠	EAN
01-101	115	6/96	5907558401677

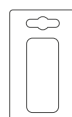

T TOPEX



Ref.	L[mm]	⊠	EAN
32D725	115	10/100	5902062132055

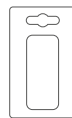

TOP TOOLS

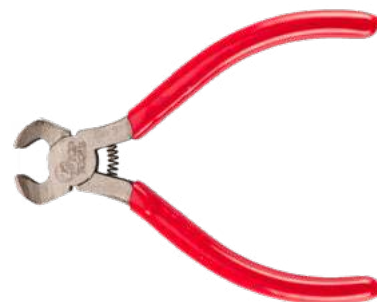

Ref.	L[mm]	⊠	EAN
32D165	105	10/100	5902062035691

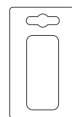

Szczypce precyzyjne okrągłe

Precision round nose pliers / Präzisions-Zangen rund / Круглозубцы прецизионные / Круглозубці прецизійні / Precíziós kerekcsőrű fogó / Clește de precizie rotund / Kleště precizní kulaté / Kliešte precízne okrúhle / Precízne klešče, okrúhle / Αρναλίοσ τίκλιος replēs / Αρναλίοσ precízας knaibles / Útarad társisnápítsad / Крылы прецизни щипцы / Precízna kliešta / Okrugla precízna klešta / Στρογγυλεμένα μυτοαίμιδια ακριβείας / Pinzas de precisión con puntas redondas / Pinza a becco tondo di precisione / Precisie ronde tangen / Alicates precisos com pontas redondas

TOPEX



Ref.	L[mm]	⊠	EAN
32D034	125	10/100	5902062009746

TOP TOOLS



Ref.	L[mm]	⊠	EAN
32D162	125	10/100	5902062035660

Szczypce precyzyjne płaskie

Precision flat pliers / Präzisionszange flach / Плоскозубцы прецизионные / Плоскозубці прецизійні / Laposcsőrű fogó / Clește plat / Kleště jemná mechanika / Kliešte ploché mikro / Ploske klešče, precízne / Plakščios replēs tikšliems darbams / Plakanknaibles / Täppislametokk-nápítsad / Клеуци човки / Kliešta plosnata / Klesta pljosnata / Πλατωαίμιδια ακριβείας γενικής χρήσης / Pinza di precisione a becco piatto / Pinças precisas planas / Pince de précision à fourches / Precisie vlakke tang

NEO TOOLS



Ref.	L[mm]	⊠	EAN
01-105	130	6/96	5907558401714

Szczypce precyzyjne

Precise pliers / Feinzange / Набор прецизионного шарнирно-зубцевого инструмента / Кусачки прецизійні / Műszerész fogókészlet / Set clești de precizie / Kleště precizní / Kliešte precízne / Precízne klešče / Replēs, precízinēs / Precízjošās knaibles / Peennápítsad / Клеуци прецизни / Precízna kliešta / Precízna klešta / Σετ πενοσειδών ακριβείας / Alicates de precisión / Set pinze di precisione / Pinças precisas / Pince de précision / Precisie tang

TOPEX



Ref.	⊠	EAN
32D755	10/40	5902062011641

Szczypce czołowe

End cutting pliers / Frontzange / Кусачки торцовые / Щипци торцеві / Homlokcsőrű fogó / Clește taiere frontala / Kleště čelní / Kliešte čelné / Čelne klešče / Kandiklēs / Kniebjamās knaibles / Otsnápítsad / Клеуци челни / Čeona kliešta / Čeona klešta / Τανάλια / Alicate de corte frontal / Tenaglia / Pinças frontais / Pince frontale / Hoofdang

NEO TOOLS



Ref.	L[mm]	⊠	EAN
01-021	160	6/48	5907558401653
01-022	200	6/48	5907558401660

TOPEX



Ref.	L[mm]	⊠	EAN
32D137	170	6/48	5902062011695

TOPEX



Ref.	L[mm]	⊠	EAN
32D543	160	6/60	5902062011404

TOP TOOLS



Ref.	L[mm]	⊠	EAN
32D143	160	12/120	5902062010223

Szczypce do pierścieni osadczych

Circlip pliers / Zange für Stellringe / Щипцы для стопорных колец / Щипцы для стопорных колец / Zégergyűrű fogó / set clește cu spirală / Kleště pro stavěcí kroužky / Segerky vonkajšie rovné / Klešče seger / Replés žiedams / Sprostgredzenu stangas / Vedrunāpīstas / Клепцы Зезер / Kružna Klješta / Kružna klešta / Ασφαλισοταιμιόδες / Alicates para anillos de asiento / Pinza per anelli elastici / Pinças p. Anéis / Pince pour bagues de retenue / Tang voor dopringen

NEO
TOOLS



- zewnętrzne proste
- external, straight tip
- щипцы для внешних/прямые

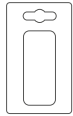

Ref.	L[mm]	Ra[mm]	☒	EAN
01-085	150	10-25	6/48	5907558440584
01-087	180	19-60	6/48	5907558440607
01-089	230	40-100	6/36	5907558440621

NEO
TOOLS



- zewnętrzne wygięte
- external, bent tip
- щипцы для внешних/загнутые

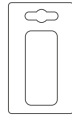

Ref.	L[mm]	Ra[mm]	☒	EAN
01-091	145	10-25	6/48	5907558440645
01-093	170	19-60	6/48	5907558440669
01-095	220	40-100	6/36	5907558440683

NEO
TOOLS



- wewnętrzne proste
- internal, straight tip
- щипцы для внутренних/прямые

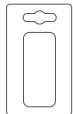

Ref.	L[mm]	Ra[mm]	☒	EAN
01-086	150	10-25	6/48	5907558440591
01-088	180	19-60	6/48	5907558440614
01-090	230	40-100	6/36	5907558440638

NEO
TOOLS



- wewnętrzne wygięte
- internal, bent tip
- щипцы для внутренних/загнутые

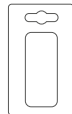

Ref.	L[mm]	Ra[mm]	☒	EAN
01-092	145	10-25	6/48	5907558440652
01-094	170	19-60	6/48	5907558440676
01-096	220	40-100	6/36	5907558440690

T TOPEX

- zewnętrzne proste
- external, straight tip
- щипцы для внешних/прямые



32D306



Ra[mm]
19-60

Ø1,8mm

- zewnętrzne wygięte
- external, bent tip
- щипцы для внешних/загнутые

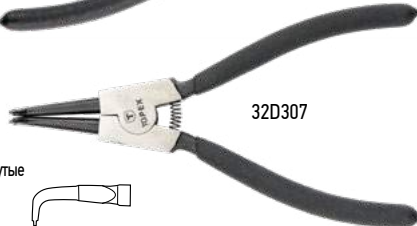

32D307

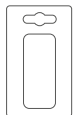

Ref.	L[mm]	☒	EAN
32D306	180	6/60	5902062323064
32D307	175	6/60	5902062323071

T TOPEX

- wewnętrzne proste
- internal, straight tip
- щипцы для внутренних/прямые



32D308



Ra[mm]
19-60

Ø1,8mm

- wewnętrzne wygięte
- internal, bent tip
- щипцы для внутренних/загнутые

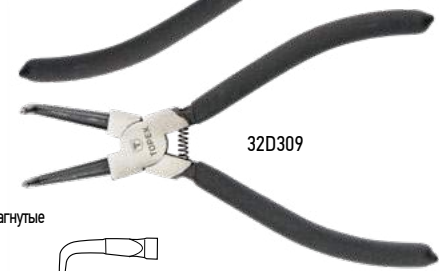

32D309

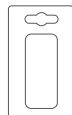

Ref.	L[mm]	☒	EAN
32D308	180	6/60	5902062323088
32D309	175	6/60	5902062323095

TOP TOOLS

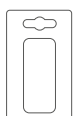

Ref.	L[mm]	☒	info	☒	EAN
32D301	150	12-25	internal, straight tip	12/120	5902062010162
32D302	150	12-25	external, bent tip	12/120	5902062010179
32D304	150	12-25	internal, bent tip	12/120	5902062010193

TOP TOOLS



x4

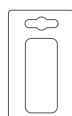

Ref.	L[mm]	☒	EAN
32D320	150	10/60	5902062010643

Obcęgi do gwoździ

Carpenters pincers / Beißzange / Клепци для гвоздей / Нараѓо фоѓо / Clește dulgher / Štirpaci klešče / Cvikavky čelné / Mizarske klešče / Žnyplės vinims / Naglu stangas / Puusepa näpitstangid / Клепци керпеден / Stolarska Klijesta / Stolarska klesta / Τανάλια Μαραγκού / Tenazas para clavos / Tenaglia da carpentiere / Turqueses p. Pregos / Tenailles à clous / Spijkertang

NEO
TOOLS

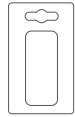

Ref.	L[mm]	⊠	EAN
01-151	180	6/48	5907558411720
01-150	200	6/48	5907558406054

TOPEX

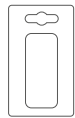

Ref.	L[mm]	⊠	EAN
32D530	180	6/60	5902062325303
32D531	200	6/60	5902062011411

TOP TOOLS



Ref.	L[mm]	⊠	EAN
32D130	180	6/60	5902062010919
32D131	200	10/60	5902062010216

Szczypce tynkarskie

Rabbit pincers / Putzange / Клепци для штукатурных работ / Щипци тинкарські / Răbitz fogó / Clește tencuială / Klešče omikárské / Klešče armovacie / Klešče za betonske armature / Replės tinkuotoji / Knipstangas / Harilikud tangid / Клепци керпеден / Armiračka Klijesta / Armiračka klesta / Πένσες οικοδομών / Tenaza rusa / Tenaglia a torre / Pinças para estuque / Pince de plâtrage / Stukadoorstang

NEO
TOOLS

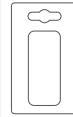

Ref.	L[mm]	⊠	EAN
01-160	250	6/48	5907558406047
01-162	300	6/36	5907558411744

TOPEX

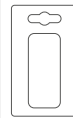

Ref.	L[mm]	⊠	EAN
32D541	250	6/60	5902062011534

TOP TOOLS



Ref.	L[mm]	⊠	EAN
32D141	250	6/60	5902062010674

Szczypce do rur

Water pump pliers / Rohrzange / Клепци трубные / Кліпци трубні / Vízpumpa fogó / clește p/u pompa de apă / Klešče na trubky / Hasák / Cevne klešče / Replės vamzdažiams / Rorstangas / Veerpumba tangid / Клепци Гапза / Klijesta rarige / Klesta paraga / Γκαζοανάλια / Tenazas para tubos / Pinza regolabile da idraulico / Pinças p. Tubos / Pince pour tubes / Buistang

NEO
TOOLS

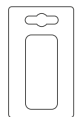
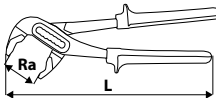

Ref.	L[mm]	Ra[mm]	⊠	EAN
01-202	250	0-36	6/48	5907558434613

NEO
TOOLS

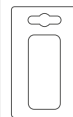

Ref.	L[mm]	Ra[mm]	⊠	EAN
01-204	250	0-42	6/48	5907558412994

NEO
TOOLS

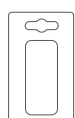

Ref.	L[mm]	Ra[mm]	⊠	EAN
01-200	240	0-31	6/48	5907558434606
01-203	300	0-46	6-24	5907558434620

TOPEX

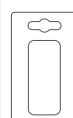

Ref.	L[mm]	Ra[mm]	⊠	EAN
32D139	250	10-45	6/48	5902062321398

Szczypce do rur

Water pump pliers / Rohrzange / Клепци трубные / Клепци трубні / Vízpumpa fogó / clește p/u pompa de apă / Kleště na trubky / Hasák / Cevne klešče / Replės vamzdžiams / Rorstangas / Veepumba tangid / Клепци Гапза / Klijesta papige / Klesta paragaļ / Γκαζοστάλια / Tenazas para tubos / Pinza regulabile da idraulico / Pinças p. Tubos / Pince pour tubes / Buistang

TOPEX

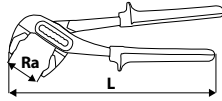

CrV



Ref.	L [mm]	Ra [mm]	☒	EAN
34D512	250	0-35	10/60	5902062345127
34D513	300	0-40	5/40	5902062345134

TOP TOOLS

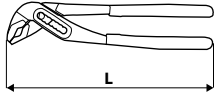

Ref.	L [mm]	☒	EAN
34D010	250	6/60	5902062010667

TOP TOOLS



Ref.	L [mm]	☒	EAN
34D020	250	6/48	5902062010131

Szczypce zaciskowe

Locking pliers / Klemmzange / Клепци зажимные / Пласкозубці обтискні / Patentfogó / Clește fixator / Upinaci kleště / Kliešte fixačné univerzálne / Prijemne klešče / Užspaudimo replės / Fiksatorstangas / Lukustustangid / Клепци Чупак / Stop klijesta / Smrt klesta / Πένσες - Γκρίν / Tenazas grip / Pinza a scatto dritta / Pinças para grampear / Pince de serrage / Krimptang

NEO TOOLS



Ref.	L [mm]	Ra [mm]	☒	EAN
01-216	250	0-47	6/36	5907558409185

NEO TOOLS



Ref.	L [mm]	Ra [mm]	☒	EAN
01-217	250	0-45	6/36	5907558409192

Szczypce zaciskowe

Locking pliers / Klemmzange / Клепци зажимные / Пласкозубці обтискні / Patentfogó / Clește fixator / Upinaci kleště / Kliešte fixačné univerzálne / Prijemne klešče / Užspaudimo replės / Fiksatorstangas / Lukustustangid / Клепци Чупак / Stop klijesta / Smrt klesta / Πένσες - Γκρίν / Tenazas grip / Pinza a scatto dritta / Pinças para grampear / Pince de serrage / Krimptang

TOPEX

CrV



Ref.	L [mm]	Ra [mm]	☒	EAN
32D856	225	0-40	6/48	5902062011671

TOPEX

CrV



Ref.	L [mm]	Ra [mm]	☒	EAN
32D857	225	0-55	6/48	5902062011688

TOPEX

CrV



Ref.	L [mm]	Ra [mm]	☒	EAN
32D855	225	0-40	6/36	5902062011442

TOPEX

CrV



Ref.	L [mm]	Ra [mm]	☒	EAN
32D456	225	0-50	6/36	5902062010278

TOP TOOLS



Ref.	L [mm]	☒	EAN
32D450	180	6/60	5902062010254
32D455	250	6/36	5902062010261

Szczypce spawalnicze

Locking wrench / Schweißzange / Клещи сварочные / Щипци обтискни / Patentfogó / Clește de blocat / Svářečské kleště / Kliešte fixačné zváračské typ W / Prijemne klešče / Replés su fiksatoriumi / Fiksátorstangas / Lukustusvõti / Клещи Чурак "W" / Stop klijesta / Smrt klesta / Πένσα συγκολλητού / Pinzas de presión para soldadura, tipo "W" / Morsetto per saldatura / Pinças p. soldagem / Pince de soudure / Lastang

T TOPEX



Ref.	L [mm]	Ra [mm]	☒	EAN
32D458	225	0-60	5/25	5902062324580

T TOPEX



Ref.	L [mm]	Ra [mm]	☒	EAN
32D459	280	0-40	5/20	5902062324597

Szczypce blacharskie

Axial grip locking pliers / Klemmzange / Клещи зажимные / Пласкозуби обтискни / Patentfogó / Clește fixator / Uprinaci klešče / Kliešte fixačné univerzálne / Prijemne klešče / Užspaidimo replés / Fiksátorstangas / Lukustusangid / Клещи чурак / Stop klijesta / Smrt klesta / Πένσαε - γκρίν / Tenazas grip / Pinza griffante / Pinças para grampear / Pince de serrage / Krimptang

NEO TOOLS

TYPE W
195 mm



Ref.	info	☒	EAN
11-020	W, max. 25 mm	1/20	5907558445473

NEO TOOLS

TYPE L
195 mm



Ref.	info	☒	EAN
11-021	L, max. 57 mm	1/20	5907558445480

NEO TOOLS

TYPE LL
205 mm



Ref.	info	☒	EAN
11-022	LL, max. 18 mm	1/20	5907558445497

NEO TOOLS

TYPE J
210 mm



Ref.	info	☒	EAN
11-023	J, max. 25 mm	1/20	5907558445503

NEO TOOLS

TYPE JJ
230 mm



Ref.	info	☒	EAN
11-024	JJ, max. 40 mm	1/20	5907558445510

Dziurkacz rewolwerowy

Revolving leather punch / Revolverlochmaschine / Дырокол револьверный / Дирокол револьверный / Bőrlukasztó fogó / Cutit de piele rotativ / Svářečské kleště / Kliešte dierkovacie / Klešče za luknjanje / Sukamasis skylamušis / Саурумситис пистольеда / Pöörlev auguraud naha jaoks / Клещи Замби / Klijesta za bušenje rupa / Klesta za busenje rupa / Περιτροφικός ζουμινός / Alicates sacabocados de revólver / Pinza a fustella per pelle / Perforador / Poinçonneuse à revolver / Ponsrevolver

T TOPEX

Ra [mm]
2,0-4,5



Ref.	L [mm]	☒	EAN
32D424	240	12/48	5902062324245

TOP TOOLS



Ref.	L [mm]	Ra [mm]	☒	EAN
32D421	225	2-5	10/60	5902062010704

Szczypce uniwersalne 1000V

Combination pliers / Kombizange / Пассатижи / Пасатижи / Kombinált fogó / Clește universal / Kombinované kleště / Klešte kombinované / Kombinirane klešče / Universalos replės / Plakanknaibles kombinētās / Universaalnähpsad / Клещи комбинирани / Kombinirana ključeta / Kombinovana klesta / Πένσα γενικής χρήσης / Alicates universales / Pinza universale 1000V / Pinças universais / Pince universelle / Universele tang

NEO
TOOLS

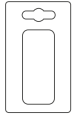

Ref.	L[mm]	⊠	EAN
01-220	160	6/60	5907558433043
01-221	180	6/60	5907558433050

NEO
TOOLS

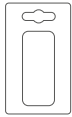

Ref.	L[mm]	⊠	EAN
01-240	160	6/48	5907558433364
01-241	180	6/48	5907558433371

T TOPEX

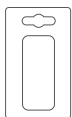

Ref.	L[mm]	⊠	EAN
32D510	160	0/10	5902062010797
32D511	180	0/10	5902062010803
32D512	200	0/10	5902062010810

Szczypce wydłużone wygięte 1000V

Long nose bent pliers / Zange lang, gebogen / Плоскозубцы удлиненные изогнутые / Щипци видовжени, вигнути / Hajlított csőrű fogó / Clește varf ascuțit indoit / Kleště prodloužené vyhnuté / Klešte predĺžené vyhnuté / Koničaste klešče - upognjene / Prailgintos replės, lenktos / Izliektas pagarinātas knaibles / Pikkade kõverate otstega nähpsad / Клещи удължени огънати / Izdužena savinuta ključeta / Izdužena uvijena klešta / Μυτοσάιμτιβο κυρτό / Alicate Telefano curvo / Pinza universale 1000V / Pinças curvadas prolongadas / Pince allongée coudées / Lange gebogen tang

NEO
TOOLS

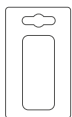

Ref.	L[mm]	⊠	EAN
01-227	160	6/60	5907558433111
01-228	180	6/60	5907558433128

Szczypce wydłużone proste 1000V

Long nose pliers / Gerade Zange, verlängert / Плоскозубцы удлиненные прямые / Πλασσοzubci z vidovazjenimi zubijami / Hosszúcsőrű fogó / Clește ascuțit bine / Kleště prodloužené rovné / Klešte špicaté rovné / Koničaste klešče / Replės pailgintos, tiesios / Plakanknaibles pagarinātās taisnās / Pikkmokk-nähpsad / Клещи Чооку / Flah Ključeta / Flah klesta / Μυτοσάιμτιβο μα μακρά ράμμινη / Alicates largos rectos / Pinza a becco lungo 1000V / Pinças retas prolongadas / Pince allongée droite / Lange rechte tang

NEO
TOOLS

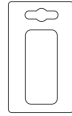

Ref.	L[mm]	⊠	EAN
01-223	160	6/60	5907558433074
01-224	180	6/60	5907558433081
01-225	200	6/60	5907558433098

NEO
TOOLS

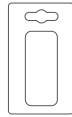

Ref.	L[mm]	⊠	EAN
01-242	160	6/48	5907558433388

T TOPEX

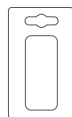

Ref.	L[mm]	⊠	EAN
32D513	160	0/10	5902062010827

Szczypce do rur 1000V

Water pump pliers / Rohrzange / Клещи трубные / Ключи трубні / Vizpumpa fogó / Clește p/u pompa de apă / Kleště na trubky / Hasák / Cevne klešče / Replės vamzdziams / Rorstangas / Veepumba tangid / Клещи Гагза / Ključeta papige / Klesta papagaj / Γκαζοσάβλια / Tenazas para tubos / Pinza giratubi 1000V / Pinças p. Tubos / Pince pour tubes / Buistang

NEO
TOOLS

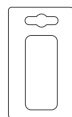

Ref.	L[mm]	⊠	EAN
01-232	250	6/36	5907558433166

Szczypce boczne 1000V

Diagonal cutting pliers / Seitenzange / Бокорезы / Бокорізи / Oldalcsípő fogó / Clește ascuțit diagonal de tăiat sîrmă / Bočni kleště / Cvikačky bočné / Stranske klešče / Šoninés replés / Sänknaibles / Diagonaal-löiketangid / Клеци Резачки / Kiješta svikerice / Klesta poluokruga / Πλαγιοκόπτες / Alicates diagonales / Tronchese laterale 1000V / Pinças laterais / Pince latérale / Zijtang

NEO
TOOLS

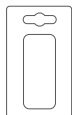

Ref.	L[mm]	⊠	EAN
01-525	160	0/36	5907558404340

NEO
TOOLS

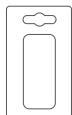

Ref.	L[mm]	⊠	EAN
01-226	160	6/60	5907558433104

NEO
TOOLS

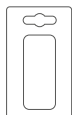

Ref.	L[mm]	⊠	EAN
01-243	160	6/48	5907558433395

NEO
TOOLS

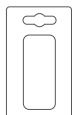

Ref.	L[mm]	⊠	EAN
01-231	180	6/60	5907558433159

NEO
TOOLS

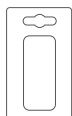

Ref.	L[mm]	⊠	EAN
01-244	180	6/48	5907558433401

TOPEX

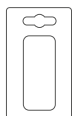

Ref.	L[mm]	⊠	EAN
32D517	160	0/10	5902062010896
32D518	180	0/10	5902062010889

Szczypce do izolacji 1000V

Wire stripper / Isolierungszange / Бокорезы для зачистки / Бокорізи для зачищування / Kábelcsupaszoló / Clește p/înlăturarea izolatoarelor / Kleště na izolaci / Kliešte odizolovacie / Klešče za snemanje izolacije / Replés izolacijai nuimti / Knaibles izolacijai / Kaablitangid / Клеци Загольвачки за монтаж / Klesta za izolaciju / Απογυμνωτές καλωδίων / Alicates pelacables / Pinza spela fili regolabile 1000V / Pinças p. Isolação / Pince à dénuder / Isolietang

NEO
TOOLS

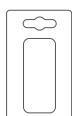

Ref.	L[mm]	⊠	EAN
01-245	160	6/48	5907558433418

NEO
TOOLS

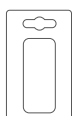

Ref.	L[mm]	⊠	EAN
01-229	160	6/60	5907558433135

Szczypce do cięcia kabli 1000V

Cable cutter / Kabelabschneider / Кабелперез / Обрізувач для кабелю / Kábelvágó fogó / Cleste pentru taiat cabluri / Kleště na kabely / Klešte na káble / Nož za rezanje kablov / Kandiklės kabeliui / Kabelu griežejis / Kaablilõikur / Резачна за кабелу / Rezač kablova / Nož za rezanje kablova / Κόφτης καλωδίων / Alicata cortacables / Taglia cavo 1000V / Cortador p. Cabos / Coupe-câbles / Knipper voor kabels

NEO
TOOLS

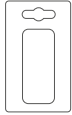

Ref.	L[mm]	⊠	EAN
01-233	160	6/60	5907558433173



Nóż monterski 1000V

Fitter's knife / Monteurmesser / Нож монтерский / Ніж монтерський / Kábelvágó kés / Cutit pentru cabluri / Nůž montérský / Montérsky nôž / Montažni nož / Montuotojo peilis / Montiera nazis / Elektrikunuga / Монтьорски нож / Monterski nož / Monterski nož / Μαχαίρι ηλεκτρολόγου / Cuchillo recto para cables / Coltello per elettricisti / Faca p. montagem / Couteau de monteur / Montagernes

NEO
TOOLS

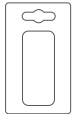
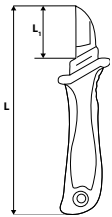

Ref.	L[mm]	L ₁ [mm]	⊠	EAN
01-550	195	50	12/72	5907558409239

NEO
TOOLS

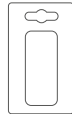

Ref.	L[mm]	L ₁ [mm]	⊠	EAN
01-551	190	50	12/72	5907558409246

Zestaw narzędzi 1000V

Tools set / Werkzeugsatz / Набор инструментов / Набор інструментів / Szerszámkészlet / Set scule de grădini / Sada nářadí / Súprava náradia / Garnitura orodja / Įrankių komplektas / Instrumentu komplekts / Τööriistakomplekt / Гедоре комплект / Set uređaja / Set alata / Συλλογή εργαλείων / Juego de herramientas / Set attrezzi 1000V / Kit de ferramentas / Jeu d'outils / Gereedschapsset

NEO
TOOLS

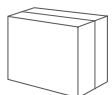

Ref.	⊠	EAN
01-236	0/8	5907558433203

NEO
TOOLS

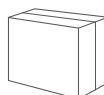

Ref.	⊠	EAN
01-235	0/6	5907558433197

Zestaw narzędzi 1000V

Tools set / Werkzeugsatz / Набор инструментов / Набор інструментів / Szerszámkészlet / Set scule de grădini / Sada nářadí / Súprava nářadí / Garnitura orodja / Įrankių kompleksas / Instrumentu komplekts / Тööriistakomplekt / Тестере комплект / Set uređaja / Set alata / Συλλογή εργαλείων / Juego de herramientas / Set attrezzi 1000V / Kit de ferramentas / Jeu d'outils / Gereedschapsset

NEO
TOOLS

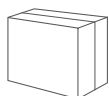

Ref. 01-237 0/8 EAN 5907558433210

NEO
TOOLS

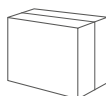

Ref. 01-234 0/6 EAN 5907558433180

Ściągacz izolacji

Wire stripper / Abziehvorrichtung für Isolierung / Съемник изоляции / Знімач ізоляції / Kábelcsupaszoló / Dispozitiv de scos izolatie / Stahovač izolace / Kliešte na stahovanie izolácie / Snemalnik izolacije / Izolācijas nuemimo replės / Izolācijas porņēms / Isolatsioonitõmmits / Изолирующая снуба / Skidač izolacije / Skidač izolacije / Εργαλείο για αφαίρεση μόνωσης / Alicates pelacables / Spelafli universale / Ponta de aperto de izolação / Dénudeur d'isolation / Trekker voor isolatie

NEO
TOOLS

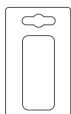

Ref. 01-524 L[mm] 125 15/90 EAN 5907558415643

NEO
TOOLS

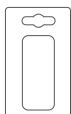

Ref. 01-400 L[mm] 170 0/40 EAN 5907558449617

TOPEX

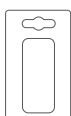

Ref. 32D405 L[mm] 165 12/72 EAN 5902062324054

TOPEX

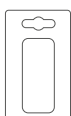

Ref. 32D810 L[mm] 130 6/96 EAN 5902062328106

Automatyczny ściągacz izolacji

Automatic wire stripper / Automat. Abziehzange / Съемник изоляции автоматический / Автоматичний стягувач ізоляції / Kábelcsupaszoló automata / Clește automatic p/u extragerea izolației / Automatické stahovadlo izolace / Kliešte odizolovacie automatické / Klešče za snemanje izolacije / Automatinis izoliacijos nuimtuvas / Stangas izolācijas noņemšanai automātiskās / Automaatsed kaablitangid / Клеци заголавачки / Kliešta za izolaciju / Αυτόματος απογυμνωτής καλωδίων / Alicates pelacables automáticos / Spelafli automatico / Aparelho automático de remover isolação / Dénudeuse d'isolation automatique / Automatisch draadstriptang

NEO
TOOLS



SK5
steel

0.34-6.0
mm²

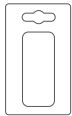

Ref.	L[mm]	⊠	EAN
01-519	195	10/60	5907558415599

NEO
TOOLS

25
years
GUARANTEE

0.5-6.0
mm

22-10 AWG

52-57 HRC

55-60 HRC

CUTTER

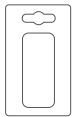

Ref.	L[mm]	⊠	EAN
01-500	205	10/60	5907558403190

T TOPEX

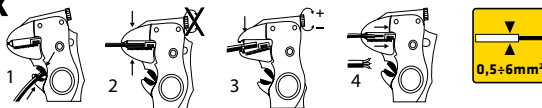

0,5÷6mm²

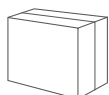

Ref.	L[mm]	⊠	EAN
32D406	175	10/50	5902062324061

NEO
TOOLS



SK5
steel

TPR

ABS

1.0, 1.6,
2.0, 2.6,
3.2 mm²

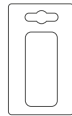

Ref.	L[mm]	⊠	EAN
01-520	170	8/48	5907558415605

NEO
TOOLS



TPR
ABS

0.5-6.0
mm

CUTTER

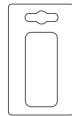

Ref.	L[mm]	⊠	EAN
01-534	180	10/40	590755843935

NEO
TOOLS

0.5-6.0
mm

22-10 AWG

CUTTER

STRIPPER

CRIMPER

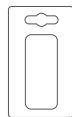

Ref.	L[mm]	⊠	EAN
01-540	200	10/40	5907558454994

T TOPEX



0,5÷6mm²

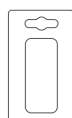

Ref.	L[mm]	⊠	EAN
32D806	210	6/60	5902062011374

Szczypce do zaciskania końcówek

Crimping pliers / Feinzunge, zur Verklemmung der Endungen / Клещи для обжима кабельных наконечников / Щипці кабельні, затискичі / Kábelsaru fogó / Cleste pentru sertizat/conectori / Kleště na svírání koncovek / Kliešte na koncovky / Kliešče za stiskanje konic / Reples, antgaliu užspaudimui / Knaibles kabelu užgaļu saspiēšanai / Otsakinnitusnäpitsad / Клеци за прутискане на краища на кабелу / Klješta za pritiskanje nastavaka / Klešta za pričvršćivanje krajeva / Πένσα ακροδεκτών / Pinzas de presión para puntas / Pinza per terminali / Pinças p. Grampear pontas / Pince universelle de serrage d'embouts / Tang voor eindstukken

NEO
TOOLS

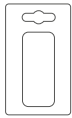

Ref.	L[mm]	⊠	EAN
01-506	220	12/24	5907558409994

NEO
TOOLS

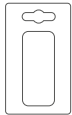

Ref.	L[mm]	⊠	EAN
01-507	170	5/20	5907558414394

NEO
TOOLS

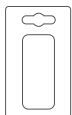

Ref.	L[mm]	⊠	EAN
01-501	195	8/48	5907558403206

NEO
TOOLS

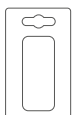

Ref.	L[mm]	⊠	EAN
01-532	140	20/80	5907558432367
01-533	140	20/80	5907558432374

NEO
TOOLS

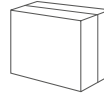

Ref.	L[mm]	⊠	EAN
01-505	210	25/50	5907558405354

NEO
TOOLS

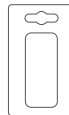

Ref.	L[mm]	⊠	EAN
01-536	210	0/20	5907558439298

NEO
TOOLS

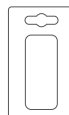

Ref.	L[mm]	⊠	EAN
01-502	250	6/36	5907558408454

NEO
TOOLS



25
years
GUARANTEE

RG
6

RG
58

RG
59

RG
62



Ref.	L[mm]	⊠	EAN
01-537	220	0/5	5907558439304

Szczypce do zaciskania końcówek

Crimping pliers / Feinzunge, zur Verklebung der Endungen / Клещи для обжима кабельных наконечников / Щипці кабельні, затиснічі / Kábelsaru fogó / Cleste pentru sertizat/conectori / Kleště na svírání koncovek / Kliešte na koncovky / Kliešče za stiskanje konic / Replés, antgalių užspaudimui / Knaibles kabelų uzgāju saspiešanai / Otsakinnitusnõpitsad / Клещи за прутискане на краища на кабелу / Klješta za pritiskanje nastavaka / Klešta za pričvršćivanje krajeva / Πένσα ακροδεκτών / Pinzas de presión para puntas / Pinza per terminali / Pinças p. Grampear pontas / Pince universelle de serrage d'embouts / Tang voor eindstukken

NEO
TOOLS

25
years
GUARANTEE

TÜV Rheinland
CERTIFIED



52-57
HRC

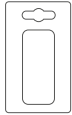

Ref.	L[mm]	⊠	EAN
01-503	250	6/36	5907558403213

NEO
TOOLS

25
years
GUARANTEE

PV
PHOTO
VOLTAIC

MC4
connector

2.5 / 4 / 6
mm²

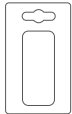

Pozycjoner w zestawie
Positioner included
Позиционер в комплекте

Ref.	L[mm]	⊠	EAN
01-555	270	10/20	5902062063427

NEO
TOOLS

25
years
GUARANTEE

EASY
SIZE
CHANGING

SOFT
HANDLE

6-50
mm²

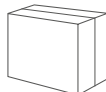
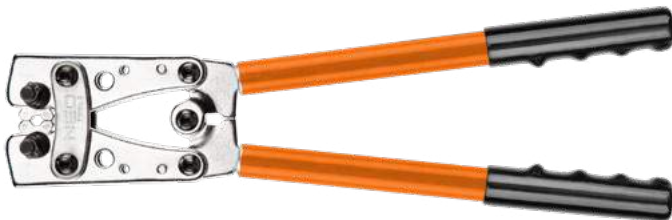

Ref.	L[mm]	⊠	EAN
01-530	390	0/10	5907558432343

NEO
TOOLS

25
years
GUARANTEE

EASY
SIZE
CHANGING

SOFT
HANDLE

10-120
mm²

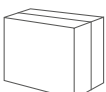

Ref.	L[mm]	⊠	EAN
01-531	610	0/5	5907558432350

TOPEX



12x
6P

12x
8P

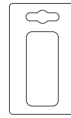

Ref.	L[mm]	⊠	EAN
32D408	185	10/30	5902062324085

TOPEX



4P
6P
8P

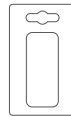

Ref.	L[mm]	⊠	EAN
32D409	195	0/50	5902062324092

TOPEX



1,0÷7mm²

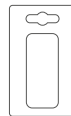

Ref.	L[mm]	⊠	EAN
32D404	210	12/72	5902062324047

TOPEX



1,5÷6mm²

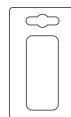

Ref.	L[mm]	⊠	EAN
32D410	230	0/60	5902062324108

TOP TOOLS

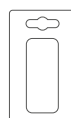

Ref.	L[mm]	⊠	EAN
32D402	200	0/100	5902062010308

Obcinak do kabli

Cable cutter / Kabelabschneider / Кабелерез / Обрѣзвач для кабелю / Kábelvágó / Cleste pentru taiat cabluri / Kliešče na kabely / Kliešte na káble / Nož za rezanje kablov / Kandiklės kabeliui / Kabeļu griezējs / Kaablilõikur / Резачка за кабелу / Rezač za kablove / Nož za rezanje kablova / Κόφτης καλωδίων / Alicate cortacables / Cesoie per cavi / Cortador p. Cabos / Coupe-câbles / Knipper voor kabels

NEO
TOOLS

25
years
GUARANTEE

TÜVRheinland
CERTIFIED

MAX
13 mm

420J2

52-54
HRC

Cu

AL

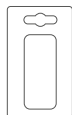

Ref.	L[mm]	⊠	EAN
01-510	185	12/72	5907558405361

NEO
TOOLS

25
years
GUARANTEE

TÜVRheinland
CERTIFIED

CrV
steel

Cu

AL

Ø MAX
30 mm

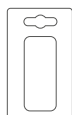

Ref.	L[mm]	max ø [mm ²]	⊠	EAN
01-516	250	325	10/30	5907558408522

NEO
TOOLS

25
years
GUARANTEE

TÜVRheinland
CERTIFIED

CrV
steel

AL

Cu

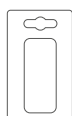

Ref.	L[mm]	max ø [mm ²]	⊠	EAN
01-517	440	20	0/12	5907558408515

NEO
TOOLS

25
years
GUARANTEE

TÜVRheinland
CERTIFIED

CrV
steel

DIN
5749

AL

Cu



Ref.	L[mm]	max ø [mm ²]	⊠	EAN
01-513	160	10	6/48	5907558408485
01-514	200	13	6/48	5907558408492
01-515	235	25	6/36	5907558408508

NEO
TOOLS

TPE

steel
60Si2Mn

400
mm²

Cu

AL

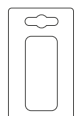

Ref.	L[mm]	⊠	EAN
01-401	400	5/10	5907558449624

Nožyce do kabli i izolacji

Cable and insulation cutter / Schere für Kabel und Isolierung / Ножницы для кабеля и изолирующей оболочки / Ножницы по кабелю и изоляции / Kábelvágóolló / Foarfeca taiat/dezizolat cabluri / Nůžky na kabely a na izolaci / Nožnice na káble a izolácie / Škarje za kable in izolaciji / Žirkles kabeliui ir izolacijai / Šķēres kabeļiem un izolācijai / Kaabli- ja izolatsioonikäärid / Ножницы за кабелю и изоляция / Škare za kablove i izolaciju / Makaze za kablove i izolaciju / Ψαλίδι καλωδίων και μόνωσης / Tijeras de electricista / Forbice da elettricista / Tesoura para cabos e isolação / Cisaille à câbles et isolation / Schaar voor kabels en isolatie

NEO
TOOLS

25
years
GUARANTEE

TÜVRheinland
CERTIFIED

57-60
HRC

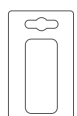
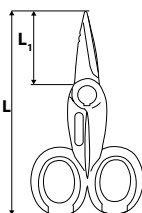

Ref.	L[mm]	L ₁ [mm]	⊠	EAN
01-511	140	45	12/72	5907558405378

Obcinak do drutów

Cable wire cutter / Abschneider für Draht / Кабелерез / Обрѣзвач до тросца / Drótvágó fogó / Cleste taiat cabluri / Kliešče na drát / Kliešte cvikacie na káble a ocelové laná / Nož za žice in jeklenice / Kandiklės vielai ir plieniniam lynui / Stieplu vai tērauda auklu griezējs / Traadi- ja terasjuhtmelõikur / Резачка за мен истоманени въжета / Rezač za žice i čelične sajle / Nož za žicu i čeličnu užad / Κόφτης καλωδίων / Alicate para cortar cable trenzado / Troncatrice per filo / Cortador de arames / Coupe-fils / Knipper voor draad

NEO
TOOLS

25
years
GUARANTEE

TÜVRheinland
CERTIFIED

CrMo
steel

ømax
6mm
• steel

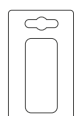

Ref.	L[mm]	⊠	EAN
01-518	210	6/48	5907558413007

Obcinak do drutów i linek stalowych

Cable and steel wire cutter / Abschneider für Draht und Stahlseilen / Кабелорез / Обрізувач до дроту і проціє / Drótvágó fogó / Cleste taiat cabluri / Kleště na drát a na ocelovú lanku / Kliešte cvikacie na káble a ocelové laná / Nož za žice in jeklenice / Kandiklės vielai ir plieniniai lynai / Stieplu vai tērauda auktu griezējs / Traadija terasjuhtmelõikur / Резачка за тел и стоманени въжета / Rezač za žice i čelične sajle / Nož za žicu i čeličnu užad / Κόφτης καλωδίων / Alicata para cortar cable trenzado / Troncatrice per cavi e fili in acciaio / Cortador p. Arames e cabos de aço / Cisaille à fils et câbles d'acier / Knipper voor draad en staalkabels

NEO
TOOLS

25
years
GUARANTEE

TÜV
CERTIFIED

SK5
steel

Ømax
1,5mm
● steel

Ømax
4mm
● steel

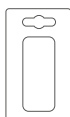

Ref.	L[mm]	⊠	EAN
01-512	190	10/60	5907558410891

Pinceta prosta

Tweezer fine tip straight / Gerade Pinzette / Пинцет прямой / Пинцет прями́й / Műszerészcsipesz / Pensetű subțire dreaptă / Pinzeta rovná / Pinzeta špicatá / Pinzeta / Tiesus pincetas / Pincete taisyne / Harilikud pintsetid / Пинцему / Pinceta / Pinceta / Ιαία τσιμίδα / Pinza recta / Pinzetta / Pinças retas / Pincette droite / Strakke pinct

T TOPEX

Hardened

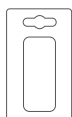

Ref.	L[mm]	⊠	EAN
32D425	135	12/288	5902062324252

Pincety

Tweezer set / Pinzetten / Пинцеты / Пинцеты, набір / Műszerészcsipesz készlet / set pensete / Pinzety / Pinzety, súprava / Garnitura pinct / Pincetas / Pincešu komplekts / Pintsettide komplekt / Pinceta set / Συλλογή λαβίδων / Pinzas / Set pinzette / Pinças / Pincettes / Pincetten

TOP TOOLS

x4

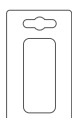

Ref.	L[mm]	⊠	EAN
32D423	120	12/240	5902062140371





KLUCZE I WKREŃTAKI
WRENCHES AND SCREWDRIVERS
КЛЮЧИ И ОТВЕРТКИ

Klucz do rur stillson

Stillson pipe wrench / Rohrschlüssel stillson / Ключ трубный stillson / Ключ трубный «Stillson» / Csőfogó „Stillson” / Cheie reglabila pentru tevi / Kleště trubkové Stillson / Ključ na rúry stillson / Ključ za cevi stillson / Raktas vamzdžiams „Stillson” / Саурулу атслэга / Stillson-torunvöti / Тръбен ключ stillson / Ključ za cijevi stillson / Ključ za cevi stillson / Σαληνοκάβουρας τύπου Stillson / Llave stillson / Giratubi Stillson / Chave p. Tubos stillson / Clef pour tubes stillson / Sleutel voor stillsonbuizen

NEO TOOLS



25 years GUARANTEE TÜV Rheinland CERTIFIED

Ref.	L[mm]	Ra [°]	☒	EAN
02-106	300/12"	1 3/4"	0/24	5907558434583
02-107	350/14"	2"	0/24	5907558434590

NEO TOOLS



25 years GUARANTEE TÜV Rheinland CERTIFIED

Ref.	L[mm]	Ra [°]	☒	EAN
02-108	240	0-31	6/48	5907558434606

NEO TOOLS



25 years GUARANTEE AL

Ref.	L[mm]	Ra [°]	☒	EAN
02-111	450	1 3/4"	0/24	5907558435856
02-112	600	2"	0/24	5907558435863

T TOPEX



Ref.	L [mm]	Ra [mm/°]	☒ [kg]	☒	EAN
34D612	250	50/1.5	0.62	6/36	5902062080950
34D613	300	70/2.0	0.94	6/24	5902062080967
34D614	350	80/2.0	1.25	6/24	5902062080974
34D615	400	90/2.5	1.79	4/12	5902062080981
34D616	600	100/3.0	2.73	2/8	5902062080998

T TOPEX



Ref.	L [mm]	Ra [mm/°]	☒ [kg]	☒	EAN
34D654	350	80/2.0	1.39	6/12	5902062081025

TOP TOOLS



Ref.	L [mm]	Ra [mm/°]	☒	EAN
34D204	350	80/2.0	6/24	5902062080127

Klucz do rur typ „S”

S-type pipe wrench / Rohrschlüssel Typ „S” / Ключ трубный S-образный / Ключ трубный, тип «S» / Svédfogó / Cheie reglabila pentru tevi, tip „S” / Kleště trubkové „S” / Ključ na rúry typ „S” / Ključ za cevi tipa „S” / Raktas „S” tipo vamzdžiams / S-tipa саурулу атслэга / S-tíipi torunvöti / Тръбен ключ тип „S” / Ključ za cijevi tip „S” / Ključ za cevi tipa „S” / Σαληνοκάβουρας τύπου S / Llave para tubos modelo sueco / Giratubi tipo „S” / Chave p. tubos tipo „S” / Clef pour tubes type „S” / Sleutel voor buizen type „S”

NEO TOOLS



25 years GUARANTEE TÜV Rheinland CERTIFIED CrV steel DIN 5234

Ref.	L[mm]	Ra [mm/°]	m[kg]	☒	EAN
02-120	235	30/0.5	0,4	0/48	5907558408645
02-121	330	40/1	0,9	0/24	5907558404067
02-122	425	55/1.5	1,5	0/12	5907558404074
02-123	535	67/2	2,4	2/8	5907558404081
02-124	650	103/3	4,2	0/4	5907558405996

Klucz do rur typ 45

Pipe wrench type 45 / Rohrschlüssel Typ „45” / Ключ трубный тип „45” / Ключ трубный, тип «45» / Svédfogó / Cheie reglabila pentru tevi, tip „45” / Kleště trubkové 45 st. / Ključ na rúry typ „45” / Ključ za cevi tipa „45” / Raktas „45” tipo vamzdžiams / 45-tipa саурулу атслэга / 45-tíipi torunvöti / Тръбен ключ тип „45” / Ključ za cijevi tipa „45” / Ključ za cevi tipa „45” / Σαληνοκάβουρας τύπου 45 / Llave para tubos modelo sueco „45” forma de S / Giratubi / Chave p. tubos tipo „45” / Clef pour tubes type „45” / Sleutel voor buizen type „45”

NEO TOOLS



25 years GUARANTEE TÜV Rheinland CERTIFIED CrV steel DIN 5234

Ref.	L[mm]	Ra [mm/°]	m[kg]	☒	EAN
02-126	330	40/1	0,8	6/24	5907558406016
02-127	415	55/1.5	1,4	4/16	5907558406023
02-128	535	67/2	2,3	0/12	5907558406030

T TOPEX



CrV S TYPE

Ref.	L [mm]	Ra [mm/°]	☒ [kg]	☒	EAN
34D701	330	40/1.0	0.78	0/30	5902062080851
34D702	420	55/1.5	1.24	1/16	5902062080868
34D703	530	67/2.0	2.33	0/10	5902062080875

T TOPEX



CrV 45°

Ref.	L [mm]	Ra [mm/°]	☒ [kg]	☒	EAN
34D761	330	40/1.0	0.66	0/30	5902062347619
34D762	420	55/1.5	1.05	1/16	5902062347626
34D763	530	67/2.0	1.78	0/10	5902062347633

TOP TOOLS



Type S

Ref.	Ra [mm/°]	☒	EAN
34D130	35/1.0	10/36	5902062081094
34D131	46/1.5	0/18	5902062081100
34D132	65/2.0	6/12	5902062081117

TOP TOOLS



45°

Ref.	Ra [mm/°]	☒	EAN
34D110	35/1.0	0/30	5902062080042
34D111	46/1.5	10/20	5902062080059
34D112	65/2.0	6/12	5902062080066

Klucz do rur typ „90”

Pipe wrench type 90 / Rohrschlüssel Typ "90" / Ключ трубный тип "90" / Ключ трубный, тип «90» / Svédfogó 90° / Cheie reglabila pentru țevi, tip "90" / Kleště trubkové 90 st. / Klíč na rúry typ „90” / Ključ za cevi tipa „90” / Raktas „90” tipo vamzdžiams / 90 tipa cauruļu atslēga / 90-tüüpi toruvõti / Тръбен ключ тип "90" / Кljuč za cijevi tip "90" / Кljuč za cevi tipa "90" / Σκληνοκάβουρας τύπου 90 / Llave para tubos modelo sueco "90" / Giratubi / Chave p. tubos tipo "90" / Clef pour tubes type "90" / Sleutel voor buizen type "90"

NEO TOOLS

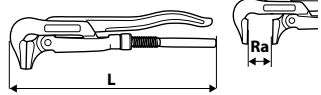

25 years GUARANTEE

TÜV Rheinland CERTIFIED

CrV steel

DIN 5234

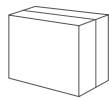

Ref.	L[mm]	Ra [mm/"]	m[kg]	☒	EAN
02-130	320	40/1	0,8	6/24	5907558411478
02-131	425	55/1.5	1,3	4/16	5907558411485
02-132	560	67/2	2,2	2/8	5907558411492

TOPEX

90°

CrV



Ref.	L [mm]	Ra [mm/"]	☐ [kg]	☒	EAN
34D751	330	40/1.0	0.65	0/30	5902062080912
34D752	420	55/1.5	1.00	1/16	5902062080929
34D753	530	67/2.0	1.70	/10	5902062080936

TOP TOOLS

90°



Ref.	Ra [mm/"]	☒	EAN
34D120	35/1.0	12/36	5902062081063
34D121	46/1.5	9/18	5902062081070
34D122	65/2.0	6/12	5902062081087

Obcinak do rur

Tube cutter / Rohrabschneider / Труборез / Τρυβορισ / Csővágó / Dispositiv tăiere țevi / Trubkořez / Rezač rúrok / Rezalec cevi / Žirkles vamzdžiams / Caurul griežējs / Torulöikur / Тръборез / Rezač cijevi / Sekacz za cevi / Κόπτης σωλήνων / Cortador de tubos / Taglia tubi / Cortador p. tubos / Coupe-tube / Buisknipper

NEO TOOLS



02-010

TÜV Rheinland CERTIFIED

25 years GUARANTEE

35 mm

56-58 HRC

AL

CU

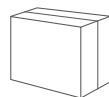

02-005

Ref.	info	☒	EAN
02-010	35 max ø [mm]	6/36	5907558408461
02-005	3 x	40/200	5907558408973

NEO TOOLS

STEEL



02-042

02-044

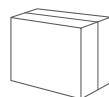

Ref.	info	Ra [mm]	Ra["]	☒	EAN
02-042	-	3-50	1/8-2.0	0/8	5907558414332
02-044	2 x	-	-	24/288	5907558415735

Klucz do śrubek z grzechotką

Pipe union ratchet wrench / Stufenschlüssel mit Ratsche / Ключ для разъемных соединений с трещоткой / Ключ до рознімних з'єднань з трісноткою / Racsnikulcs radiátorszelephéz / Cheie pentru imbinari de tevi cu clichiet / Klíč na šroubení s ráčnou / Klíč na nákrutky s račňou / Večstopenski ključ z ragljo / Raktas sujungimams su terkšle / Savienotājuztavas tarkšatslēga / Kõristiga toruliitmikuvõti / Ключ за съединителни муфи със зъбче / Imbus ključ sa čegrtaljkom / Ključ za aramturu sa čegrtaljkom / Κλειδί για λιόμενες συνδέσεις με κασάνα / Chiave a cricchetto / Chiave a cricchetto per raccordi / Chave para junção com catraca / Clé pour garniture de raccord à cliquet / Sleutel voor koppelstukken met ratel

NEO TOOLS

25 years GUARANTEE

CrV steel

1/2"

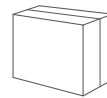

Ref.	info	☒	EAN
02-060	3/8" - 9,5 mm; 15/32" - 12 mm; 1/2" - 12,7 mm; 21/32" - 16,8 mm; 7/8" - 22 mm	0/20	5907558418804

Końcówka klucza do śrubek

Step wrench bit / Rohrverschraubung / Разъемное соединение / Проставка / Racsnis kulcs / Connector Filetat / Šroubení / Nákrutka / Fiting / Varžtas / Savienotājuztavas / Mutter / Съединителна муфа / Cijevna spojnica / Zavrtnaj / Λιομενη συνδεση / Tuercas / Raccordo / Junção / Raccord-union

NEO TOOLS

CrV steel

1/2"

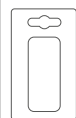

Ref.	info	☒	EAN
02-069	3/8" - 9,5 mm; 15/32" - 12 mm; 1/2" - 12,7 mm; 21/32" - 16,8 mm; 7/8" - 22 mm	0/50	5907558415742

NEO TOOLS



02-010

TÜV Rheinland CERTIFIED

25 years GUARANTEE

35 mm

56-58 HRC

AL

CU

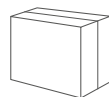

02-005

Ref.	info	☒	EAN
02-010	35 max ø [mm]	6/36	5907558408461
02-005	3 x	40/200	5907558408973

NEO TOOLS

STEEL



02-042

02-044

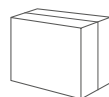

Ref.	info	Ra [mm]	Ra["]	☒	EAN
02-042	-	3-50	1/8-2.0	0/8	5907558414332
02-044	2 x	-	-	24/288	5907558415735

NEO TOOLS



02-055

AL

CU

Ref.	ø [mm]	☒	EAN
02-051	15	10/60	5907558442793
02-052	18	10/60	5907558442809
02-053	22	10/60	5907558442816
02-054	28	10/60	5907558442823
02-055	-	20/120	5907558442830

NEO TOOLS



02-040

02-041

25 years GUARANTEE

TÜV Rheinland CERTIFIED

max 2.5mm

STEEL

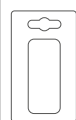

Ref.	Ra [mm]	Ra["]	☒	EAN
02-040	19-83	3/4-3.1/4	10/30	5907558410006
02-041	-	-	20/80	5907558410013

Obcinak do rur

Tube cutter / Rohrabschneider / Τρυβορέας / Τρυβοπίσ / Csővágó / Dispositiv tăiere țevi / Trubkořez / Rezač rúrok / Rezalec cevi / Žirkles vamzdiams / Caurulgriezējs / Torulõikur / Τρυβορέας / Rezač cijevi / Sekac za cevi / Κόπτης σωλήνων / Cortador de tubos / Taglia tubi / Cortador p. tubos / Coupe-tube / Buisknipper

NEO
TOOLS



45 mm

PCV

PP

56-58 HRC

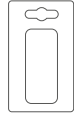

Ref.	max ø [mm]	⊠	EAN
02-020	45	6/24	5907558408478

TOPEX



34D031

Cu

AL

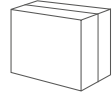

Ref.	Ra [°]	Ra [mm]	⊠	EAN
34D031	1/8-7/8	3-22	50/200	5902062340313
34D052			40/400	5902062340528

TOPEX



Cu

AL

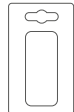

Ref.	Ra [°]	Ra [mm]	⊠	EAN
34D033	1/8-1.1/4	3-32	12/48	5902062340337
34D052			40/400	5902062340528

TOPEX



STEEL

34D056

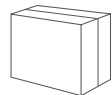

Ref.	Ra [°]	Ra [mm]	⊠	EAN
34D038	1/2 - 2	12-50	0/10	5902062340382
34D056			20/100	5902062081056

TOPEX



PCV

PE

PP

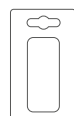

Ref.	Ra [°]	Ra [mm]	⊠	EAN
34D036	1/4-2.3/8	6-63	6/24	5902062340368
34D053			60/240	5902062340535

NEO
TOOLS



02-073
02-074
02-075

RUBBER HANDLE

Replaceable BLADE

PCV

PP

02-076, 02-077, 02-078

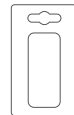

Ref.	max ø [mm]	⊠	EAN
02-073	42	10/40	5907558442847
02-074	50	10/40	5907558442854
02-075	63	10/40	5907558442861
02-076	-	12/72	5907558442885
02-077	-	12/72	5907558442892
02-078	-	12/72	5907558442878

TOPEX



Cu

AL

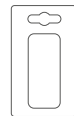

Ref.	Ra [°]	Ra [mm]	⊠	EAN
34D032	1/8-1.1/4	3-32	12/72	5902062340320
34D052			40/400	5902062340528

TOPEX



Cu

AL

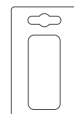

Ref.	Ra [°]	Ra [mm]	⊠	EAN
34D037	1/4-1.3/4	6-45	8/32	5902062340375
34D053			60/240	5902062340535

TOPEX



PCV

PE

PP

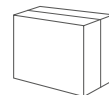

Ref.	Ra [°]	Ra [mm]	⊠	EAN
34D034	0-1.5/8	0-42	6/36	5902062340344

TOP TOOLS



Cu
AL

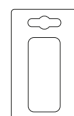

Ref.	L [mm]	Ra [mm]	⊠	EAN
34D055	165	3-28	10/80	5902062080561

Obcinak do rur

Tubing cutter / Rohrabscneider / Τρυβορέζ / Τρυβορία / Csővágó / Dispozitiv tăiere țevi / Trubkořez / Rezač rúrok / Rezalec cevi / Žirkles vamzdžiams / Caurulgriezējs / Torulõikur / Τρυβορέζ / Rezač cijevi / Sekac za cevi / Κόπτης σωλήνων / Cortador de tubos / Taglia tubi / Cortador p. tubos / Coupe-tube / Buisknipper

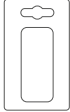

Ref.	L [mm]	Ra [mm]	☒	EAN
34D065	200	3-42	0/48	5902062080554

Przyrząd do modelowania końcówek rur

Tubbing cutter and flaring tool set / Gerät zum Modellieren von Rohrenden / Τρυβορέζ u rozvalyčovaci, набор / Комплект инструмента до порізки та розвальцовки труб / Csővágókészlet / Dispozitiv pentru modelarea pieselor de îmbinare a țevilor / Zařízení na tvarování nástavců trubek / Sada nástrojov na modelovanie nástavcov rúr / Orodje za rezanje in robljenje cevi / Vamzdžių atgalių užspaudimo ir praplėtimo įrankių rinkinys / Caurulgriežu un cauruļu izvelmētāju komplekts / Komplekt torude lōikamiseks ja valtsimiseks / Комплект инструменти за рязане u моделуране краищата на тръби / Alat za narezivanje i modeliranje cijevi / Pribor za modelovanje krajeva cevi / Κόπτης σωλήνων και εργαλείο για διεύρυνση σωλήνων, σετ / Herramienta para amoldar las puntas de tubos / Utensile per modellare il fine tubo / Aparelho p. formar ponteiros de tubos / Outil de modelage d'embouts de tubes / Knijgereedschap voor eindstukken



Ref.	Ra[mm/"]	☒	EAN
02-050	4, 4.75, 6, 8, 10, 12, 14 mm	0/12	5907558410020

Imadło do rur

Pipe Vice / Rohrschraubstock / Тиски трубные / Леуцата для труб / Csősatu / Menghina de tevi / Trubkový svěrák / Zverák na rúrky / Primež za cevi / Vamzdžių spaustuvas / Cauruļu spīles / Torukruustangid / Менгеме за тръби / Stega za cijevi / Stege za cev / Μέγενη σωλήνων / Mordaza de tuberías / Morsa per tubi / Torno para tubos / Etou pour tubes / Bankschroef voor buizen

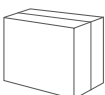

Ref.	Ra [mm]	☒	EAN
34D082	10 - 60	0/6	5902062340825

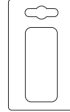

Ref.	Ra [mm]	☒	EAN
34D067	3-42	0/48	5902062049896

Gratownik

Trimmer / Entgrater / Зенковка для труб / Гратознімач / Sorjázó / Debavurator / Odhrotovač / Skracovačka / Sveder za cev / Kīrstukas vamzdžiams / Cauruļu gredmurbis / Kraatide emaldi / Τρυμερ / Strugač za cijevi / Alat za uklanjanie orijaka / Αλεξούαρ για σωλήνες / Desbarbador de tubo / Sbatovatore per tubi / Rebarbador de tubos / Ebavureur / Ruimer



02-066



02-072

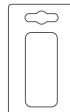

Ref.	Info	☒	EAN
02-066		0/150	5907558418866
02-072	3 x	10/300	5907558415759

TOPEX

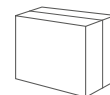

Ref.	Ra ["]	Ra [mm]	☒	EAN
34D070	1/4-1.5/8	6-40	24/72	5902062340702

Spirala kanalizacyjna

Plumber snake / Rohrspirale / канализационная спираль / Спираль канализаційна / Csőtisztító spirál / Spirala canalizare / kanalizační spirála / kanalizačná špirála / Kanalizacijska spirala / Kanalizacijos valymo spiralė / Kanalizācijas spirāle / Kanalisatsioonitross / канализационна спирала / Kanalizacijska spirala / Kanalizaciona spirala / Αποφρακτικός άξονας σπирάλ / Pulitore per tubi di scarico / Espiral de esgotos / Furet de plombier / Rioolspiraal

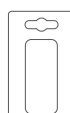

Ref.	Ø [mm]	L [m]	☒	EAN
34D301	5	1.5	20/80	5902062343017
34D305	8	5	10/20	5902062343055
34D308	10	8	0/8	5902062343086

KLUCZ NASTAWNY

Adjustable wrench / Schraubenschlüssel / Ключ разводной / Ключ розвідний гайковий / Csavarkulcs állítható / Cheie reglabilă / Ključ přestavitelný / Nastavitel'nyj ključ / Francoski ključ / Reguliuojamas raktas / Bidatslēga / Tellitan vōti / Раздвижен гаечен ключ / Podesivi ključ / Francuski ključ / Γαλλικό κλειδί / Llave inglesa / Chiave a rullino / Chave regulável / Clef à ouverture réglable / Verstelbare moersleutel

NEO
TOOLS

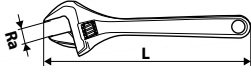

25
years
GUARANTEE

CrV
steel

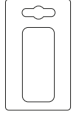

Ref.	Ra [mm]	L [mm]	☒	EAN
03-017	0-30,5	200	0/36	5907558404326

NEO
TOOLS

25
years
GUARANTEE

TUV
Rheinland
CERTIFIED

CrV
steel

DIN
3117

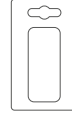

Ref.	L [mm]	Ra [mm]	☒	EAN
03-010	150	0-24	6/120	5907558404111
03-011	200	0-28.6	6/60	5907558404128
03-012	250	0-32.8	6/48	5907558404135
03-013	300	0-38	6/24	5907558404142

NEO
TOOLS

25
years
GUARANTEE

TUV
Rheinland
CERTIFIED

CrV
steel

DIN
3117

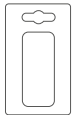

Ref.	L [mm]	Ra [mm]	☒	EAN
03-015	150	0-34	6/96	5907558412208
03-014	200	0-38	6/72	5907558404159
03-016	250	0-50	5/30	5907558412215

NEO
TOOLS

25
years
GUARANTEE

CrV
steel

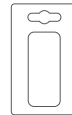

Ref.	L [mm]	Ra [mm]	☒	EAN
03-027	150	0-23	6/120	5907558426090
03-028	200	0-28	6/60	5907558426106
03-029	250	0-32	6/48	5907558426113

NEO
TOOLS

25
years
GUARANTEE

CrV
steel

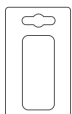

Ref.	L [mm]	Ra [mm]	☒	EAN
03-023	155	0-28	6/72	5907558426052
03-024	205	0-32	6/72	5907558426069
03-025	256	0-43	6/36	5907558426076
03-026	306	0-53	6/36	5907558426083

NEO
TOOLS

25
years
GUARANTEE

CrV
steel

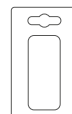

Ref.	L [mm]	Ra [mm]	☒	EAN
03-019	118	0-28	6/72	5907558426014
03-020	139	0-32	6/72	5907558426021
03-021	156	0-43	6/36	5907558426038
03-022	185	0-53	6/36	5907558426045

TOPEX

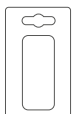

Ref.	L [mm]	Ra [mm]	☒	EAN
35D555	150	0-24	6/60	5902062355553
35D556	200	0-31	6/60	5902062355560
35D557	250	0-35	6/36	5902062355577
35D558	300	0-41	6/24	5902062355584

TOPEX

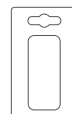

Ref.	L [mm]	Ra [mm]	☒	EAN
35D121	150	0-20	6/60	5902062042484
35D122	200	0-24	6/60	5902062042439
35D123	250	0-29	6/36	5902062042132
35D124	300	0-35	6/24	5902062042149

TOPEX

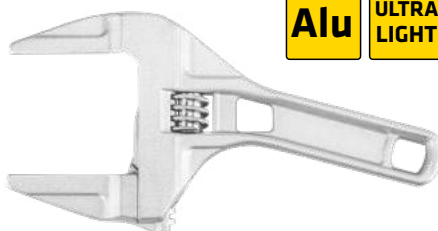

Alu
ULTRA
LIGHT
200
[mm]

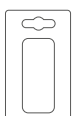

Ref.	L [mm]	Ra [mm]	☒	EAN
35D700	200	0-70	6/60	5902062030856

TOPEX

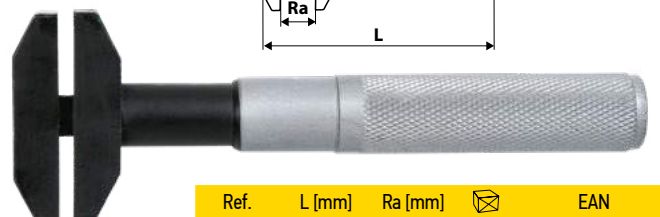
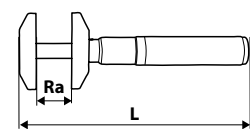

Ref.	L [mm]	Ra [mm]	☒	EAN
35D154	260	0-55	0/5	5902062042590
35D156	260	0-65	0/5	5902062040220

Klucz nastawny

Adjustable wrench / Schraubenschlüssel / Ключ разводной / Ключ розвідний гайковий / Csavarkulcs állítható / Cheie reglabilă / Klíč přestavitelný / Nastavitelný klíč / Francoski ključ / Reguluojamas raktas / Bidatslēga / Tellitan vōti / Раздвижен гаечен ключ / Podesivi ključ / Francuski ključ / Γαλλικό κλειδί / Llave inglesa / Chiave a rullino / Chave regulável / Clef à ouverture réglable / Verstelbare moersleutel

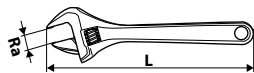

Ref.	L [mm]	Ra [mm]	☒	EAN
35D112	200	0-24	6/60	5902062040176
35D113	250	0-29	6/36	5902062040183
35D114	300	0-35	6/24	5902062040190
35D115	375	0-47	2/12	5902062040206

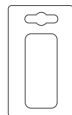

Ref.	L [mm]	Ra [mm]	☒	EAN
35D117	150	0-17	6/72	5902062031020
35D118	200	0-22	6/60	5902062031051
35D119	250	0-27	6/36	5902062031143
35D120	300	0-32	6/24	5902062031150

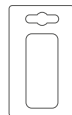

TECNOLOGIA SUPERLOCK

SUPERLOCK TECHNOLOGY / ТЕХНОЛОГИЯ SUPER LOCK

- Nasadki NEO wykonane w technologii SUPERLOCK:
- większy moment obrotowy
- optymalny rozkład sił
- ochrona kształtu główki śruby przed zniszczeniem
- możliwość użycia nasadki do śrub już zniszczonych
- użycie nasadek zwiększa trwałość elementów mocujących

- NEO sockets are manufactured in SUPERLOCK technology:
- greater torque
- optimal force distribution
- protection of bolt head against damage
- socket can be used on damaged bolts
- use of sockets improves durability of joining elements

- Сменные головки NEO изготовлены по технологии SUPERLOCK:
- больше крутящий момент
- оптимальное распределение нагрузки
- защита головки болта от повреждения
- возможность использования сменной головки при работе с поврежденными болтами
- использование сменных головок повышает прочность крепежа

Główny nacisk na ściankę – optymalny rozkład sił
Main pressure on a side wall – optimum force distribution
Основной нажим на стенку – оптимальное распределение нагрузки

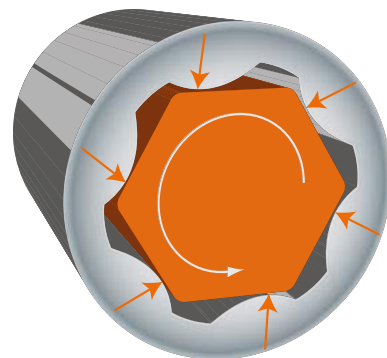

Nasadka sześciokątna

Hexagonal socket / Sechskanteinsatz / Головка сменная шестигранная / Насадка шестигранная / Dugókulcs / Cheie tubulara hexagonală / Šestihranný nástavec / Šesthranný nástavec / Šestkotni natični nastavek / Šešiakampis antgalis / Sešstūra nomaināmā galva / Kuuskantpradrun / Шестогъелна наставка / Šesterokutna kapica / Šestougaona nasadka / Καρυδάκι εξαγώνο / Vaso para destornillador hexagonal / Bussola esagonale / Bocal hexagonal / Douille à 6 pans / Zeskant dop

NEO TOOLS



NEO TOOLS

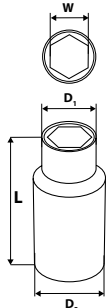
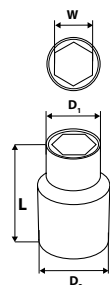

Ref.	w[mm]	L[mm]	D ₁ [mm]	D ₂ [mm]	☒	EAN
08-220	4	25	7	12	100/500	5907558403787
08-221	4,5	25	7,5	12	100/500	5907558403794
08-222	5	25	8	12	25/200	5907558403800
08-223	5,5	25	8,5	12	25/200	5907558403817
08-224	6	25	9	12	100/200	5907558403824
08-225	7	25	10,5	12	25/200	5907558403831
08-226	8	25	12	12	25/200	5907558403848
08-227	9	25	13	13	50/500	5907558403855
08-228	10	25	14	14	25/200	5907558403862
08-229	11	25	16	16	50/500	5907558403879
08-230	12	25	17	17	15/150	5907558403886
08-231	13	25	18	18	15/150	5907558403893
08-232	14	25	20	20	50/500	5907558403909

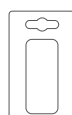
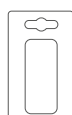

Ref.	w[mm]	L[mm]	D ₁ [mm]	D ₂ [mm]	☒	EAN
08-235	4	50	7	12	50/500	5907558412055
08-236	4,5	50	7,5	12	50/500	5907558412062
08-237	5	50	8	12	50/500	5907558412079
08-238	5,5	50	8,5	12	50/500	5907558412086
08-239	6	50	9	12	50/500	5907558412093
08-240	7	50	10,5	12	25/200	5907558412109
08-241	8	50	12	12	50/200	5907558412116
08-242	9	50	13	13	50/200	5907558412123
08-243	10	50	14	14	25/200	5907558412130
08-244	11	50	16	16	50/150	5907558412147
08-245	12	50	17	17	50/300	5907558412154
08-246	13	50	18	18	50/150	5907558412161
08-247	14	50	20	20	50/150	5907558412178

Nasadka sześciokątna

Hexagonal socket / Sechskanteinsatz / Головка сменная шестигранная / Nasadka szesciokątna / Dugókulcs / Cheie tubulara hexagonală / Šestihranný nástavec / Šestihranný nástavec / Šestkotni natični nastavek / Šešiakampis antgalis / Sešštūra pomaināmā galva / Kuuskantpadrun / Шестоугольная наставка / Šesterokutna kopica / Šestougaona nasadka / Καρυδάκι εξήγωνο / Vaso para destornillador hexagonal / Bussola esagonale / Bocal hexagonal / Douille à 6 pans / Zeskant dop

NEO
TOOLS

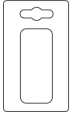
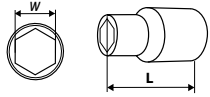

Ref.	W [mm]	L [mm]	☒	EAN
08-442	4	25	25/200	5907558423280
08-443	4.5	25	25/200	5907558423297
08-444	5	25	25/200	5907558423303
08-445	5.5	25	25/200	5907558423310
08-446	6	25	25/200	5907558423327
08-447	7	25	25/200	5907558423334
08-448	8	25	25/200	5907558423341
08-449	9	25	25/200	5907558423358
08-450	10	25	25/200	5907558423365
08-451	11	25	15/150	5907558423372
08-452	12	25	15/150	5907558423389
08-453	13	25	15/150	5907558423396
08-454	14	25	15/150	5907558423402

NEO
TOOLS

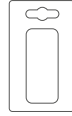
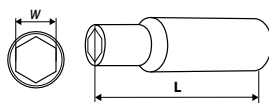

Ref.	W [mm]	L [mm]	☒	EAN
08-487	4	50	25/200	5907558423679
08-488	4.5	50	25/200	5907558423686
08-489	5	50	25/200	5907558423693
08-490	5.5	50	25/200	5907558423709
08-491	6	50	25/200	5907558423716
08-492	7	50	25/200	5907558423723
08-493	8	50	25/200	5907558423730
08-494	9	50	25/200	5907558423747
08-495	10	50	25/200	5907558423754
08-496	11	50	15/150	5907558423761
08-497	12	50	15/150	5907558423778
08-498	13	50	15/150	5907558423785
08-499	14	50	15/150	5907558423792

NEO
TOOLS

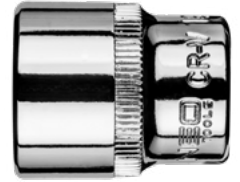
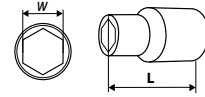

Ref.	W [mm]	L [mm]	☒	EAN
08-168	8	30	20/200	5907558422757
08-170	10	30	20/200	5907558422764
08-171	11	30	20/200	5907558422771
08-172	12	30	20/200	5907558422788
08-173	13	30	20/200	5907558422795
08-174	14	30	20/200	5907558422801
08-175	15	30	20/200	5907558422818
08-176	16	30	20/200	5907558422825
08-177	17	30	20/200	5907558422832
08-178	18	30	20/200	5907558422849
08-179	19	30	20/200	5907558422856
08-180	20	30	20/200	5907558422863
08-181	21	30	20/200	5907558422870
08-182	22	30	20/200	5907558422887

NEO
TOOLS

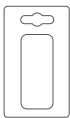
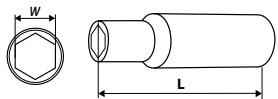

Ref.	W [mm]	L [mm]	☒	EAN
08-184	8	63	20/200	5907558422894
08-185	10	63	20/200	5907558422900
08-186	11	63	20/200	5907558422917
08-187	12	63	20/200	5907558422924
08-188	13	63	20/200	5907558422931
08-189	14	63	20/200	5907558422948
08-190	15	63	20/200	5907558422955
08-191	16	63	20/200	5907558422962
08-192	17	63	20/200	5907558422979
08-193	18	63	20/200	5907558422986
08-194	19	63	20/200	5907558422993
08-195	20	63	20/100	5907558423000
08-196	21	63	20/100	5907558423013
08-197	22	63	20/100	5907558423020

NEO
TOOLS

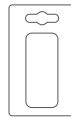
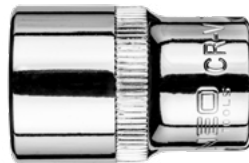
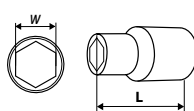

Ref.	W [mm]	L [mm]	☒	EAN
08-408	8	38	20/200	5907558423037
08-409	9	38	20/200	5907558423044
08-410	10	38	20/200	5907558423051
08-411	11	38	20/200	5907558423068
08-412	12	38	20/200	5907558423075
08-413	13	38	20/200	5907558423082
08-414	14	38	20/200	5907558423099
08-415	15	38	20/200	5907558423106
08-416	16	38	20/200	5907558423112
08-417	17	38	20/200	5907558423129
08-418	18	38	20/200	5907558423136
08-419	19	38	20/200	5907558423143
08-420	20	38	20/200	5907558423150
08-421	21	38	20/200	5907558423167
08-422	22	38	20/200	5907558423174
08-423	23	38	20/200	5907558423181
08-424	24	38	20/200	5907558423198
08-425	25	38	10/100	5907558423204
08-426	26	42	10/100	5907558423211
08-427	27	42	10/100	5907558423228
08-428	28	42	10/100	5907558423235
08-429	29	44	10/100	5907558423242
08-430	30	44	10/100	5907558423259
08-431	31	44	10/100	5907558423266
08-432	32	44	10/100	5907558423273

NEO
TOOLS

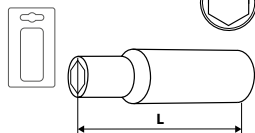

Ref.	W [mm]	L [mm]	☒	EAN
08-458	8	77	20/200	5907558423419
08-459	9	77	20/200	5907558423426
08-460	10	77	20/200	5907558423433
08-461	11	77	20/200	5907558423440
08-462	12	77	20/200	5907558423457
08-463	13	77	20/200	5907558423464
08-464	14	77	20/200	5907558423471
08-465	15	77	20/200	5907558423488
08-466	16	77	20/200	5907558423495
08-467	17	77	20/200	5907558423501
08-468	18	77	20/200	5907558423518
08-469	19	77	20/200	5907558423525
08-470	20	77	20/100	5907558423532
08-471	21	77	20/100	5907558423549
08-472	22	77	20/100	5907558423556
08-473	23	77	20/100	5907558423563
08-474	24	77	20/100	5907558423570
08-475	25	77	10/50	5907558423587
08-476	26	77	10/50	5907558423594
08-477	27	77	10/50	5907558423600
08-478	28	77	10/50	5907558423617
08-479	29	77	10/50	5907558423624
08-480	30	77	10/50	5907558423631
08-481	31	77	10/50	5907558423648
08-482	32	77	10/50	5907558423655
08-486	36	77	4/40	5907558423662

Nasadka sześciokątna

Hexagonal socket / Sechskanteinsatz / Головка сменная шестигранная / Nasadka sześciokątna / Dugókulcs / Cheie tubulara hexagonală / Šestihranný nástavec / Šesthranný nástavec / Šestkotni natični nastavek / Šešiakampis antgalis / Sešštura potaināmā galva / Kiuskapradrun / Шестоъгълна наставка / Sesterokutna kapica / Šestougaona nasadka / Карбука ежъгълно / Vaso para destornillador hexagonal / Bussola esagonale / Boca hexagonal / Douille à 6 pans / Zeskant dop

NEO
TOOLS

25
years
GUARANTEE

TUV
Rheinland
CERTIFIED

CrV
steel

1/2"

SUPERLOCK

DIN
3124

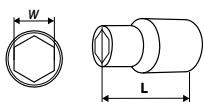

Ref.	W [mm]	L [mm]	⊠	EAN
08-008	8	38	20/200	5907558403503
08-009	9	38	20/200	5907558403510
08-010	10	38	20/100	5907558402353
08-011	11	38	20/100	5907558403527
08-012	12	38	20/100	5907558402360
08-013	13	38	20/200	5907558402377
08-014	14	38	20/100	5907558408232
08-015	15	38	20/200	5907558402384
08-016	16	38	20/200	5907558403534
08-017	17	38	20/200	5907558402391
08-018	18	38	20/200	5907558403541
08-019	19	38	20/200	5907558402407
08-020	20	38	10/100	5907558412451
08-021	21	38	20/200	5907558403558
08-022	22	38	20/200	5907558402414
08-023	23	38	10/100	5907558412468
08-024	24	38	20/100	5907558402421
08-025	25	38	10/100	5907558412475
08-026	26	42	10/100	5907558403565
08-027	27	42	10/100	5907558402438
08-028	28	42	10/100	5907558403572
08-029	29	44	10/100	5907558403589
08-030	30	44	10/100	5907558402445
08-032	32	44	10/100	5907558402452
08-036	36	44	10/0	5907558403602

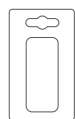

NEO
TOOLS

25
years
GUARANTEE

TUV
Rheinland
CERTIFIED

CrV
steel

1/2"

SUPERLOCK

DIN
3124

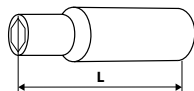

Ref.	W [mm]	L [mm]	⊠	EAN
08-039	8	77	12/144	5907558410501
08-040	9	77	20/200	5907558410518
08-041	10	77	20/200	5907558402469
08-052	11	77	20/176	5907558410525
08-042	12	77	20/200	5907558402476
08-043	13	77	20/200	5907558402483
08-053	14	77	20/176	5907558410532
08-044	15	77	20/200	5907558402490
08-054	16	77	12/144	5907558410549
08-045	17	77	20/200	5907558402506
08-055	18	77	20/96	5907558410556
08-046	19	77	20/200	5907558402513
08-056	21	77	6/96	5907558410563
08-047	22	77	6/96	5907558402520
08-058	23	77	6/72	5907558412499
08-048	24	77	6/72	5907558402537
08-049	27	77	10/100	5907558402544
08-050	30	77	10/50	5907558402551
08-051	32	77	6/48	5907558402568

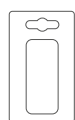

NEO
TOOLS

25
years
GUARANTEE

TUV
Rheinland
CERTIFIED

CrV
steel

3/4"

SUPERLOCK

DIN
3124

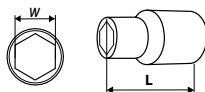
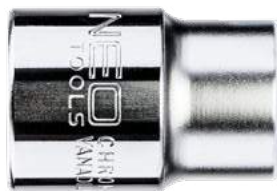

Ref.	W [mm]	L [mm]	⊠	EAN
08-300	19	51	10/80	5907558404180
08-301	21	51	10/100	5907558410600
08-302	22	51	10/80	5907558404197
08-303	23	51	10/100	5907558412512
08-304	24	51	10/100	5907558404203
08-305	25	51	10/80	5907558412529
08-317	26	52	10/80	5907558412536
08-306	27	52	10/80	5907558404210
08-307	28	52	10/60	5907558412543
08-318	29	53	10/60	5907558412550
08-308	30	54	10/60	5907558404227
08-309	32	56	10/60	5907558404234
08-316	34	56	10/60	5907558410624
08-319	35	57	10/60	5907558412567
08-311	36	59	10/40	5907558404241
08-312	38	60	10/40	5907558404258
08-313	41	64	10/40	5907558404265
08-314	46	68	10/20	5907558404272
08-315	50	72	10/20	5907558404289
08-340	55	76	10/20	5907558412574
08-341	60	78	10/20	5907558412581

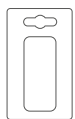

TOPEX

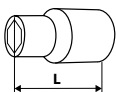

1/2"

CrV

SUPERLOCK

Ref.	W [mm]	L [mm]	⊠	EAN
38D710	10	38	20/200	5902062043511
38D712	12	38	20/240	5902062043528
38D713	13	38	20/160	5902062043535
38D714	14	38	20/160	5902062043542
38D715	15	38	20/160	5902062043559
38D716	16	38	20/240	5902062043566
38D717	17	38	20/200	5902062043573
38D718	18	38	20/240	5902062043580
38D719	19	38	20/200	5902062043597
38D721	21	38	20/200	5902062043603
38D722	22	38	20/200	5902062043610
38D724	24	38	20/200	5902062043627
38D727	27	42	10/100	5902062043634
38D730	30	44	10/100	5902062043641
38D732	32	45	10/100	5902062043658

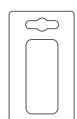

TOPEX

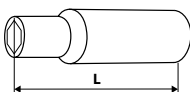

1/2"

CrV

SUPERLOCK

Ref.	W [mm]	L [mm]	⊠	EAN
38D751	10	76	20/200	5902062387516
38D753	13	76	20/200	5902062387530
38D755	16	76	20/200	5902062387554
38D756	17	76	20/200	5902062387561
38D757	19	76	20/200	5902062387578
38D760	24	76	12/60	5902062357601
38D761	27	76	10/50	5902062387615
38D762	30	76	10/50	5902062387622
38D763	32	76	12/48	5902062387639

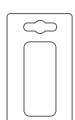

Jedna nasadka – wiele zastosowań!

One socket – many applications! / Одна головка – много вариантов применения!

SPLINE = UNIWERSALNE

Wszechstronność dzięki sferycznemu, 12-kątnemu kształtowi. Umożliwia pracę z większością śrub (Torx, SPLINE, 12-kątne, 6-kątne, metryczne, calowe, o kształcie kwadratu).

SPLINE = MULTIPURPOSE

Versatile use thanks to spherical, 12 point shape. Allows to work with most bolt heads (Torx, SPLINE, 12-point, hexagonal, metric, imperial, square).

SPLINE = УНИВЕРСАЛЬНЫЕ

Универсальность благодаря сферической, 12-гранной форме. Дает возможность работать с большинством винтов (Torx, SPLINE, 12-гранными, 6-гранными, метрическими, дюймовыми, квадратной формы).

ROZMIAR SIZE РАЗМЕР (mm)	INCH		STAR	SPLINE	KWADRAT	
	6-kątna	12-kątna			MM	INCH
4	5/32"	5/32"	E5	M10		
4.5			E6	M12	4	
5	3/16"	3/16"			4.5	
5.5	7/32"	7/32"		M14	5	
6	1/4"	1/4"	E8	M16	6	
7	9/32"	9/32"			7	9/32"
8	5/16"	5/16"	E10	M18	8	5/16"
9	11/32"	11/32"			9	11/32"
10	3/8"	3/8"	E12	M20	10	3/8"
11	7/16"	7/16"	E14		11	7/16"
12	15/32"	15/32"	E16		12	15/32"
13	1/2"	1/2"			13	1/2"
14	9/16"	9/16"	E18		14	9/16"
15	19/32"	19/32"			15	19/32"
16	5/8"	5/8"	E20		16	5/8"
17	11/16"	11/16"			17	11/16"
18	23/32"	23/32"	E22		18	23/32"
19	3/4"	3/4"	E24		19	3/4"
20	25/32"	25/32"			20	25/32"
21	13/16"	13/16"	E26		21	13/16"
22	7/8"	7/8"	E28		22	7/8"
23					23	
24	15/16"	15/16"	E30		24	15/16"
25					25	
26					26	
27	1.1/16"	1.1/16"	E34		27	1.1/16"
28					28	
29	1.1/8"	1.1/8"			29	1.1/8"
30	1.3/16"	1.3/16"	E38		30	1.3/16"
32	1.1/4"	1.1/4"	E42		32	1.1/4"

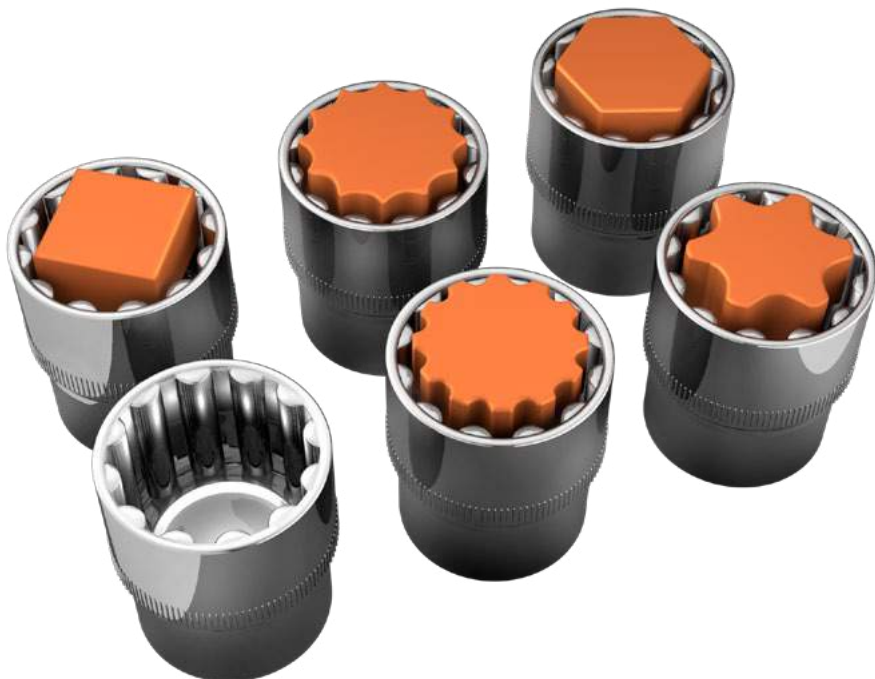

Nasadka dwunastokątna

Bi-hexagonal socket / Zwölfkanteinsatz / Головка сменная двенадцатигранная / Насадка двенадцатигранная / Dugókulcs 12 pontos / Cheie tubulara, priză în 12 pute / Dvanáctihránný nástavec / Dvanášttrhanný nástavec / Dvanajstkotni nasadni ključ / Dvylíkakampis antgális / Divradmístičra pomainātmā galva / Kaksteiskantpradrin / Дванадцетогрълна наставка / Dvanaesterokutna kapica / Dvanaestougona nasadka / Καρυβάκι δωδεκάγωνο / Vaso destornillador de encaje dodecagonal / Bussola Spline / Bocal de doze ângulos / Douille à 12 pans / Twaalfkant dop

NEO
TOOLS

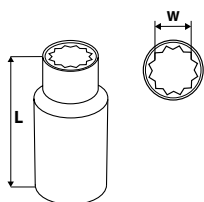

NEO
TOOLS

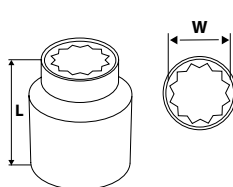

Ref.	W[mm]	L[mm]	☒	EAN
08-070	10	77	8/200	5907558405613
08-086	11	77	12/144	5907558410594
08-071	12	77	20/200	5907558405620
08-072	13	77	12/200	5907558405637
08-073	14	77	20/200	5907558408249
08-074	15	77	12/144	5907558405644
08-075	16	77	20/200	5907558406078
08-076	17	77	20/200	5907558405651
08-077	18	77	6/96	5907558406085
08-078	19	77	6/96	5907558405668
08-080	21	77	6/96	5907558408256
08-081	22	77	6/120	5907558405675
08-082	24	77	6/72	5907558405682
08-083	27	77	6/72	5907558405699
08-084	30	77	10/50	5907558405705
08-085	32	77	6/948	5907558405712

Ref.	W[mm]	L[mm]	☒	EAN
08-320	19	50	10/80	5907558406108
08-333	21	52	10/80	5907558410631
08-321	22	50	10/80	5907558406115
08-322	24	51	10/80	5907558406122
08-323	27	52	10/80	5907558406139
08-324	30	54	10/60	5907558406146
08-325	32	56	10/60	5907558406153
08-335	34	56	10/60	5907558410655
08-326	36	58	10/60	5907558406160
08-327	38	60	10/40	5907558406177
08-328	41	64	10/40	5907558406184
08-329	46	68	10/20	5907558406191
08-331	55	76	10/20	5907558406214
08-332	60	79	10/20	5907558406221

Nasadka dwunastokątna

Bi-hexagonal socket / Zwölfkanteinsatz / Головка сменная двенадцатигранная / Nasadka dwanaścigranna / Dugókulcs 12 pontos / Cheie tubulara, priza in 12 pute / Dvanáctihranný nástavec / Dvanásthřanný nástavec / Dvanajstkotni nasadni ključ / Dvylīkākampis antgalis / Divpadmīstūra nomaīnāimā galva / Kaksteistkānpadrin / Дванадесетъгълна наставка / Dvanaesterokutna kapica / Dvanaestougaona nasadka / Καριδάκι δωδεκάγωνο / Vaso destornillador de encaje dodecagonal / Bussola Spline / Bocal de doze ângulos / Douille à 12 pans / Twaalfkant dop

NEO TOOLS

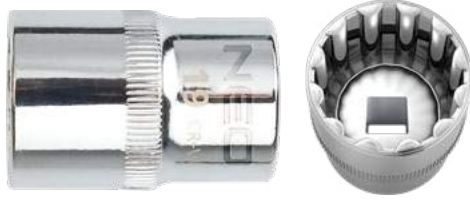
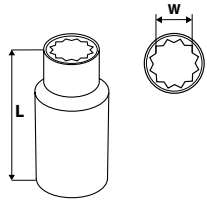

Ref.	W[mm]	L[mm]	☒	EAN
08-580	8	38	10/200	5907558408263
08-581	9	38	10/100	5907558408270
08-582	10	38	20/100	5907558408287
08-583	11	38	10/100	5907558408294
08-584	12	38	10/100	5907558408300
08-585	13	38	10/200	5907558408317
08-586	14	38	10/200	5907558408324
08-587	15	38	10/100	5907558408331
08-588	16	38	10/200	5907558408348
08-589	17	38	10/200	5907558408355
08-590	18	38	10/200	5907558408362
08-591	19	38	10/100	5907558408379
08-592	20	38	10/100	5907558408386
08-593	21	38	10/100	5907558408393
08-594	22	38	10/100	5907558408409
08-595	23	38	10/100	5907558412505
08-596	24	38	10/200	5907558408416
08-597	27	42	10/100	5907558408423
08-598	30	44	10/100	5907558408430
08-599	32	44	10/100	5907558408447

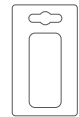

NEO TOOLS

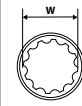

MM	10	12	13	15	17	19	22	24
INCH	3/8	15/32	1/2	19/32		3/4	7/8	15/16
STAR	E12	E16					E24	

Ref.	W[mm]	☒	EAN
08-651	10,12,13,15,17,19,22,24	0/30	5907558406290

NEO TOOLS

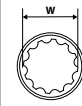

MM	10	12	13	15	17	19	22	24
INCH	3/8	15/32	1/2	19/32		3/4	7/8	15/16
STAR	E12	E16					E24	

Ref.	W[mm]	m[kg]	☒	EAN
08-650	10,12,13,15,17,19,22,24	1,1	0/20	5907558406293

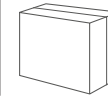

Grzechotka

Ratchet handle / Ratsche / Трещотка / Держак з тріскоткою / Racsnikulus / Mīner de hurluitoare / Řehtačka / Račňa prepínacia / Raglja / Terkšlë / Reversa atslëga / Pörkratta pide / Трещотка / Račva za nasadni ključ / Račva za gedoru / Κασιπάκι / Llave de carraca / Cricchetto / Catraca de furar / Clé à cliquet / Rate!

NEO TOOLS

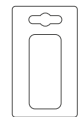
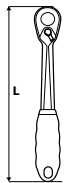

Ref.	Info	L[mm]	☒	EAN
08-530	1/4"	155	10/50	5907558435689
08-533	3/8"	200	5/25	5907558435696
08-536	1/2"	250	5/20	5907558435702

NEO TOOLS

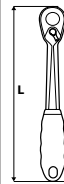

Ref.	Info	L[mm]	☒	EAN
08-503	1/4"	145	10/50	5907558412819
08-507	3/8"	195	5/60	5907558412833
08-520	1/2"	255	5/25	5907558412840

NEO TOOLS

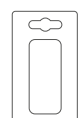
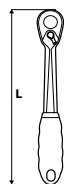

Ref.	Info	L[mm]	☒	EAN
08-540	1/4"	155	5/50	5907558435719
08-543	3/8"	200	5/25	5907558435726
08-546	1/2"	250	5/20	5907558435733

NEO TOOLS



Ref.	Info	L[mm]	☒	EAN
08-504	1/4"	150	10/50	5907558420708
08-508	3/8"	210	6/48	5907558420715
08-521	1/2"	265	5/25	5907558420722

Grzechotka

Ratchet handle / Ratsche / Трещотка / Держак з тріснотною / Racsnikulcs / Miner de hurluitoare / Řehtačka / Račňa prepínacia / Raglja / Terkšlè / Reversa atslèga / Pörkratta pide / Трещотка / Račva za nasadni ključ / Račva za gedoru / Καρτανά / Llave de carraca / Cricchetto / Catraca de furar / Clé à cliquet / Ratel

NEO
TOOLS



Ref.	Info	L[mm]	☒	EAN
08-523	1/4"	155	6/72	5907558432190
08-524	3/8"	200	6/48	5907558432206
08-525	1/2"	250	6/36	5907558432213

NEO
TOOLS



Ref.	Info	L[mm]	☒	EAN
08-514	1/4"	150	12/72	5907558406276
08-513	3/8"	200	12/48	5907558406269
08-511	1/2"	250	0/24	5907558402605

NEO
TOOLS



Ref.	Info	Lmin[mm]	Lmax[mm]	☒	EAN
08-502	1/4"	150	200	10/50	5907558412802
08-506	3/8"	215	315	12/48	5907558412826
08-515	1/2"	305	445	0/25	5907558408546

NEO
TOOLS

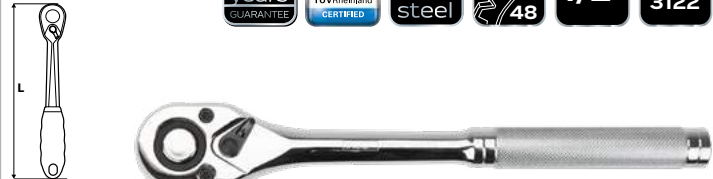

Ref.	Info	L[mm]	☒	EAN
08-516	1/2"	255	6/24	5907558409291

NEO
TOOLS



Ref.	Info	L[mm]	☒	EAN
08-519	1/2"	285	0/24	5907558410167

NEO
TOOLS

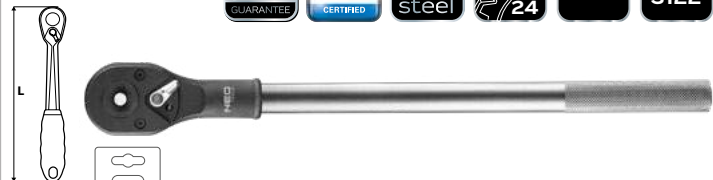

Ref.	Info	L[mm]	☒	EAN
08-355	3/4"	500	0/16	5907558404449

NEO
TOOLS



Ref.	Info	L[mm]	☒	EAN
08-501	1/4"	105	10/100	5907558412185

NEO
TOOLS



Ref.	Info	L[mm]	☒	EAN
08-512	1/4"	105	10/60	5907558403305

T TOPEX



Ref.	W	L[mm]	☒	EAN
38D501	1/4"	150	10/60	5902062043139
38D521	3/8"	200	10/60	5902062043146
38D541	1/2"	250	10/40	5902062041876

T TOPEX



Ref.	W	L[mm]	☒	EAN
38D502	1/4"	150	10/60	5902062385024
38D522	3/8"	210	10/60	5902062385222
38D540	1/2"	250	10/40	5902062385406

Grzechotka

Ratchet handle / Ratsche / Трещотка / Держак з трісцючкою / Racsnikulcs / Míner de hurluitoare / Řehtačka / Račna prepričina / Raglja / Terkšle / Reversa atslēga / Pörkratta pide / Трещотка / Račna za nasadni ključ / Racva za gedoru / Καστανιά / Llave de carraca / Cricchetto / Catraca de furar / Clé à cliquet / Rate!

TOPEX

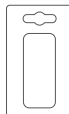
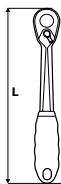

Ref.	L [mm]	⊠	EAN
38D542	255	10/40	5902062385420

TOPEX

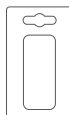
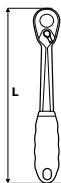

Ref.	L [mm]	⊠	EAN
38D543	135	12/48	5902062385437

TOP TOOLS

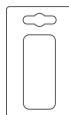
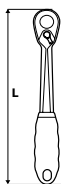

Ref.	Info	L [mm]	⊠	EAN
38D101	1/4"	150	25/100	5902062041227
38D121	3/8"	200	25/50	5902062041234
38D141	1/2"	250	12/48	5902062041241

Pokrętko

Wheel / Drehknopf / Вороток / Маховик / Hajtókár / Clupă / Otočný knoflík / Ovládacie koliesko / Raglja / Rankena / Grietzuvite / Nurr / Върток / Kотаці / Ručica / Пáмoлo / Mango / Impugnatura a L / Botão / Tourne-à-gauche / Draaiknop

NEO TOOLS

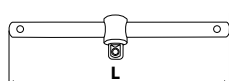

Ref.	Info	L [mm]	⊠	EAN
08-256	1/4"	110	20/200	5907558403961
08-155	3/8"	165	20/100	5907558403770
08-555	1/2"	250	5/25	5907558402650
08-353	3/4"	460	10/10	5907558404425

Rękojeść z przegubem

Flex handle / Handgriff mit Gelenk / Вороток / Руків'я з шарніром / Hajtókár flexibilis / Maner cu articulație / Kloubové vratidlo / Klbová rukovät' / Ročaj z zglobom / Rankena su lankstu / Pagarinātājs mucipatslēgai / Liigendiga käepide / Ръкохватка с шарнир / Drška sa zglobom / Drška sa zglobom / Μανέλα ολιβαίνουσα / Mango con articulación / Impugnatura telescopica / Cabo com Articulação / Poignée articulée / Handvat met spilverbinding

NEO TOOLS

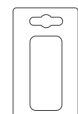
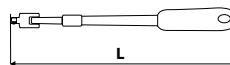

Ref.	Lmin [mm]	Lmax [mm]	⊠	EAN
08-553	470	620	5/20	5907558409598

NEO TOOLS

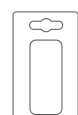
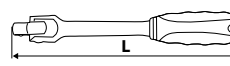

Ref.	L [mm]	⊠	EAN
08-559	250	10/40	5907558403367
08-560	450	10/20	5907558403374

NEO TOOLS

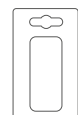
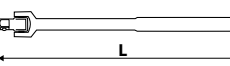

Ref.	L [mm]	⊠	EAN
08-356	510	0/10	5907558404456

TOPEX

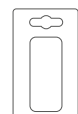
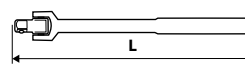

Ref.	L [mm]	⊠	EAN
38D557	250	20/40	5902062385574
38D558	450	10/20	5902062385581

NEO TOOLS

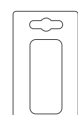
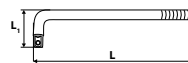

Ref.	Info	L [mm]	L ₁ [mm]	⊠	EAN
08-556	1/2"	250	75	0/40	5907558408607
08-357	3/4"	450	110	0/10	5907558405873

Pokrętło

Wheel / Drehknopf / Вороток / Маховик / Hajtókár / Clupă / Otočný knoflík / Ovládacie koliesko / Raglja / Rankena / Grietzvite / Nupp / Върток / Kolačići / Ručica / Пóмолo / Mango / Impugnatura a L / Botão / Tourne-à-gauche / Draaiknop

TOPEX

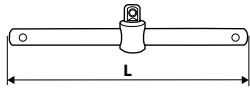

1/2" CrV

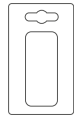

Ref.	L [mm]	⊠	EAN
38D552	250	10/50	5902062044198

TOPEX

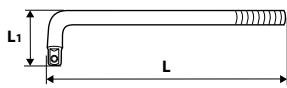

1/2" CrV

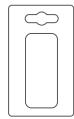

Ref.	L [mm]	L1 [mm]	⊠	EAN
38D556	250	75	20/40	5902062385567

TOP TOOLS

1/2"

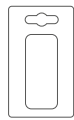

Ref.	L [mm]	⊠	EAN
38D152	250	0/50	5902062041760

Przegub

Articulated joint / Gelenk / Шарнир / Сусмае / Kardáncsukló / Articulatie / Kloub / Čap / Zglob / Lanktas / Šarniřs / Klamber / Шарнир / Zglob / Zglob / Μετρεός / Articulación / Giunto articolato / Articulação / Articulation / Spilverbinding

NEO TOOLS

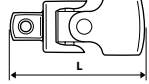

25 years GUARANTEE
TÜV Rheinland CERTIFIED
CrV steel
DIN 3123

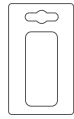

Ref.	Info	L [mm]	⊠	EAN
08-255	1/4"	35	50/400	5907558403954
08-154	3/8"	50	50/400	5907558403763
08-551	1/2"	65	10/80	5907558402629

TOPEX

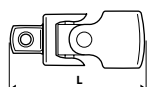

1/2" CrV

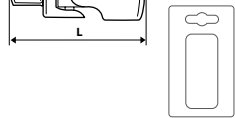

Ref.	L [mm]	⊠	EAN
38D555	75	20/120	5902062044167

Redukcja

Adaptor / Reduzierstück / Переходник / Перехідник / Adapter / Adaptor / Redukce / Redukcia / Adapter / Adapteris / Päreja / Адаптор / Adapter / Προσαρμογέας / Adaptador / Adattatore / Redução / Réduction / Reductiestuk

NEO TOOLS



25 years GUARANTEE
TÜV Rheinland CERTIFIED
CrV steel
DIN 3123

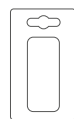

Ref.	Info	L [mm]	⊠	EAN
08-562	1/4" M x 3/8" F	26	10/100	5907558403329
08-563	3/8" M x 1/2" F	37	10/100	5907558403336
08-565	1/2" M x 3/4" F	50	40/40	5907558403350
08-564	3/4" M x 1/2" F	46	10/100	5907558403343
08-550	1/2" M x 3/8" F	27	25/200	5907558402612

Przedłużka

Extension bar / Verlängerung / Удлинитель / Подовжувач / Toldósár / Prolungitor / Prodłużovák / Predĺženie / Podaljšek / Ilgiklis / Pagarinātājs / Píkendusvarras / Удължител / Produziena poluga / Προέκταση / Alargadera / Prolunga / Extensão / Prolongation / Verlengstuk

NEO TOOLS

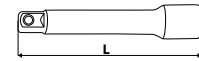

25 years GUARANTEE
TÜV Rheinland CERTIFIED
CrV steel
1/4"
DIN 3123

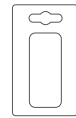

Ref.	L [mm]	⊠	EAN
08-251	50	20/200	5907558403916
08-252	75	20/200	5907558403923
08-253	100	25/50	5907558403930
08-254	150	25/50	5907558403947

NEO TOOLS

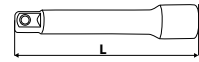

25 years GUARANTEE
TÜV Rheinland CERTIFIED
CrV steel
3/8"
DIN 3123

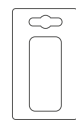

Ref.	L [mm]	⊠	EAN
08-151	75	20/200	5907558403732
08-152	125	20/200	5907558403749
08-153	150	20/100	5907558403756

NEO TOOLS

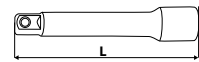

25 years GUARANTEE
TÜV Rheinland CERTIFIED
CrV steel
1/2"
DIN 3123

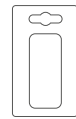

Ref.	L [mm]	⊠	EAN
08-552	125	10/50	5907558402636
08-554	250	10/50	5907558402643

NEO TOOLS

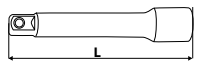

25 years GUARANTEE
TÜV Rheinland CERTIFIED
CrV steel
3/4"
DIN 3123

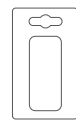

Ref.	L [mm]	⊠	EAN
08-350	100	10/40	5907558404296
08-351	200	10/20	5907558404302
08-352	400	0/10	5907558404418

NEO TOOLS

Przedłużka elastyczna
Flexible extension
Удлинитель гибкий

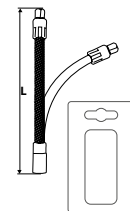

TÜV Rheinland CERTIFIED
CrV steel
1/4"



Ref.	L [mm]	M _{max} [Nm]	⊠	EAN
08-557	140	5	25/100	5907558402667

NEO TOOLS

Przedłużka elastyczna
Flexible extension
Удлинитель гибкий

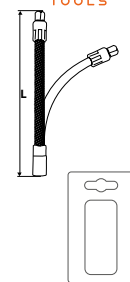

TÜV Rheinland CERTIFIED
CrV steel
1/2"



Ref.	L [mm]	M _{max} [Nm]	⊠	EAN
08-558	190	40	10/80	5907558402674

Przedłużka

Extension bar / Verlängerung / Удлинитель / Подовжувач / Toldósár / Prelungitor / Prodlužovák / Predĺženie / Podaljšek / Ilgiklis / Pagarinātājs / Pikendusvarras / Удължувач / Produziena poluga / Προέκταση / Alargadera / Prolunga / Extensão / Prolongation / Verlengstuk

TOPEX

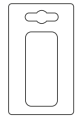
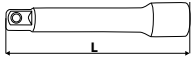

1/2" CrV

Ref.	L [mm]	⊠	EAN
38D553	125	20/120	5902062044174
38D554	250	20/60	5902062044181

TOP TOOLS

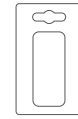

1/2"

Ref.	L [mm]	⊠	EAN
38D159	125, 250	0/25	5902062041296

Klucze nasadowe

Socket wrenches / Steckschlüssel / Набор сменных головок / Ключи торцови / Dugkulcskészlet / Trusa tubulare / Nástrčné kľuče / Nástrčné klúče / Nasadni ključji / Verzlérakció antgai / Nomaināmo galvu komplekts / Padrunvõtmed / Сменными наконечниками за ключове / Nasadni ključevi / Ključevi natičaji / Σετ με καρυδάκια / Laves de vaso / Set di bussole SuperLock / Chaves tubulares / Clefs à douilles / Dopsleutels

NEO TOOLS

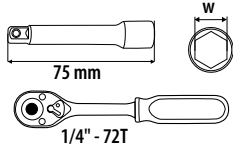

Ref.	W[mm]	⊠	EAN
08-652	4, 4.5, 5, 5.5, 6, 7, 8, 9, 10, 11, 12, 13	5/20	5907558412963

NEO TOOLS

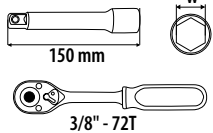

Ref.	W[mm]	⊠	EAN
08-653	8, 10, 12, 13, 14, 16, 17, 19, 21, 22	6/24	5907558412970

NEO TOOLS

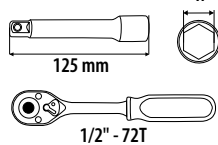

Ref.	W[mm]	⊠	EAN
08-654	8, 10, 12, 13, 14, 16, 17, 19, 21, 22	6/12	5907558412987

NEO TOOLS

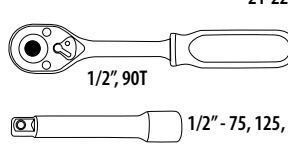

1/2" SUPERLOCK - 8-10-11-12-13-14-15-16-17-18-19-21-22-24-27-30-32 mm

25 years GUARANTEE



CrV steel

1/2"



x23



Ref.	⊠	EAN
08-694	1/5	5907558440034

NEO TOOLS

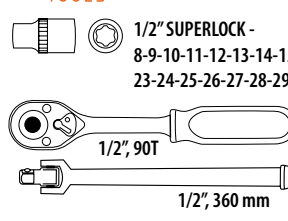

1/2" SUPERLOCK - 8-9-10-11-12-13-14-15-16-17-18-19-20-21-22-23-24-25-26-27-28-29-30-32-34-35-36 mm

25 years GUARANTEE



CrV steel

1/2"



x33



Ref.	⊠	EAN
08-692	1/4	5907558440034

Klucze nasadowe

Socket wrenches / Steckschlüssel / Набор сменных головок / Ключи торцевые / Dugókulcskészlet / Trusa tubulară / Nástrčné klíče / Nástrčné klúče / Nasadni ključji / Veržlerakció antgajai / Nomināmo galvu komplekts / Padrunvõtmed / Сменными наконечниками за ключовые / Nasadni ključevji / Ključevji natičaki / Σετ με καρβύδια / Llaves de vaso / Set di bussole SuperLock / Chaves tubulares / Clefs à douilles / Dopsleutels

NEO
TOOLS



1/2" SPLINE - 10-11-12-13-14-15-16-17-18-19-20-21-22-23
-24-27-30-32 mm

1/4" SPLINE - 4-4.5-5-5.5-6-7-8-9-10-11-12-13 mm

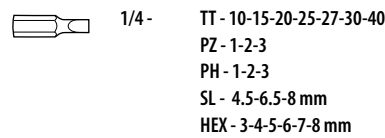
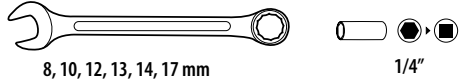
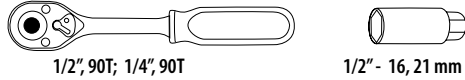
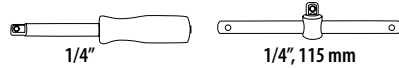

Ref. 08-690 EAN 0/10 5907558440010

NEO
TOOLS



1/4" - 4-4.5-5-5.5-6-7-8-9-10-11-12-13-14 mm

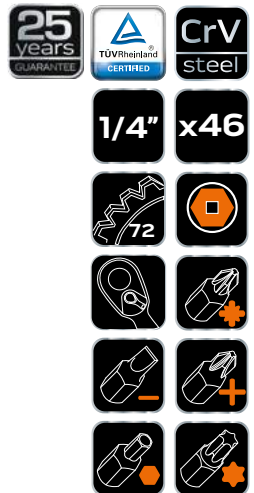
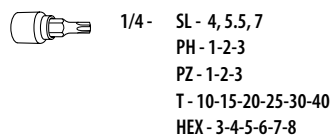
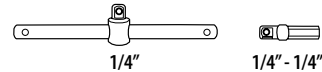
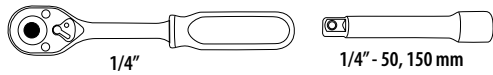

Ref. 08-660 EAN 0/10 5907558417319

NEO
TOOLS



1/2" - 10-11-12-13-14-15-16-17-18-19-20-
21-22-23-24-27-30-32 mm

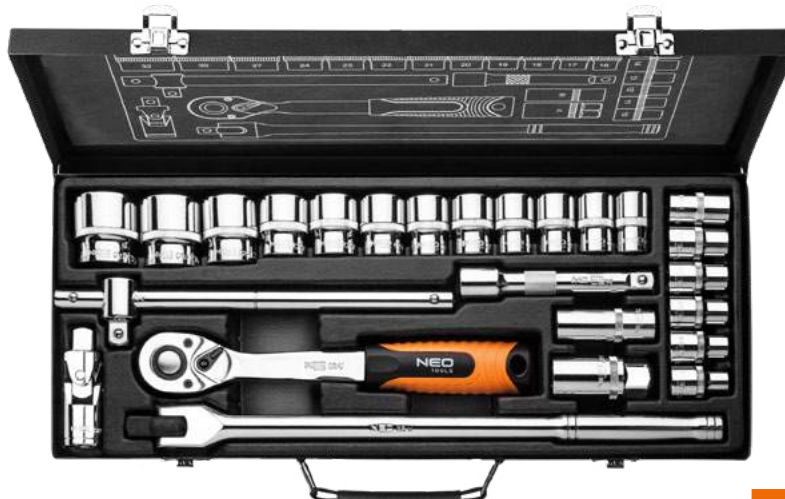
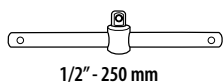
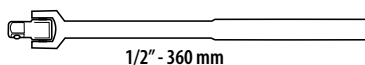
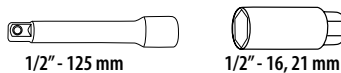
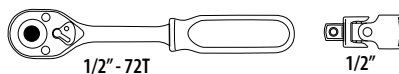

Ref. 08-674 EAN 0/4 5907558421606

Klucze nasadowe

Socket wrenches / Steckschlüssel / Набор сменных головок / Ключи торцевые / Dugókulcskészlet / Trusa tubulare / Nástrčné kľúče / Nástrčné kľúče / Nasadni ključiči / Verzlérakció antgaliak / Nomināmo galvu komplekts / Padrūnviņtmed / Сменная накруйница за ключове / Nasadni ključeviči / Ključeviči natičakči / Σετ με καρδιάκια / Llaves de vaso / Set di bussolle SuperLock / Chaves tubulares / Clefs à douilles / Dopsleutels

NEO
TOOLS

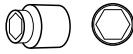
 3/4" - 19-21-22-23-24-26-27-29-30-32-35-36-38-41-46-50 mm

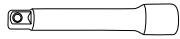
 3/4" - 100, 200, 400 mm

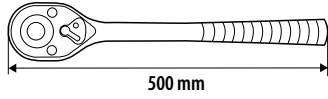
 500 mm

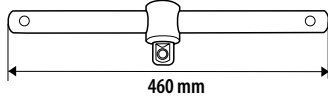
 460 mm



25
years
GUARANTEE

TÜVRheinland
CERTIFIED

CrV
steel

x21

3/4"

24



Ref.  EAN
08-061 0/1 5907558404173

NEO
TOOLS

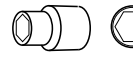
 1/4" - 4-4.5-5-5.5-6-7-8-9-10-11-12-13-14 mm

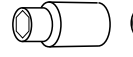
 1/4" - 4-4.5-5-5.5-6-7-8-9-10-11-12-13-14 mm

 1/4" - E4-E5-E6-E7-E8-E10

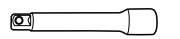

 1/4" - 72T

 1/4" - 50, 100, 150 mm

 1/4" - 110 mm

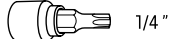
 1/4"

 1/4" - SL4-SL5-SL7
PH1-PH2-PH3
PZ1-PZ2-PZ3
T8-T10-T15-T20-T25-T30-T40
H3-H4-H5-H6-H7-H8

 1/4"  30 mm

 1/4" - 140 mm



25
years
GUARANTEE

TÜVRheinland
CERTIFIED

CrV
steel

x63

1/4"

72





Ref.  EAN
08-679 5/10 5907558422139

NEO
TOOLS

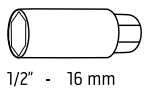
 1/2" - 10-11-12-13-14-15-16-17-18-19-22-24 mm

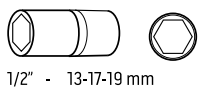
 1/2" - 16 mm

 1/2" - 13-17-19 mm

 1/2"

 1/2" - 250 mm

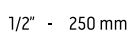
 1/2"

 1/2"

 1/2"

 1/2"



25
years
GUARANTEE

TÜVRheinland
CERTIFIED

CrV
steel

x20

1/2"

72





Ref.  EAN
08-661 0/5 5907558417357

Klucze nasadowe

Socket wrenches / Steckschlüssel / Набор сменных головок / Ключи торцевые / Dugókulcskészlet / Trusa tubulare / Nástrčné kľuče / Nástrčné kľuče / Nasadni ključiči / Veržlerakció antgataliai / Nomaināmo galvu komplekts / Padrunvõtmed / Сменная накруйница за ключове / Nasadni ključeviči / Ključeviči natičkači / Σετ με καρδιάκια / Llaves de vaso / Set di bussole SuperLock / Chaves tubulares / Clefs à douilles / Dopsleutels

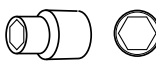
NEO
TOOLS

 1/2" - 8 - 9 - 10 - 11 - 12 - 13 - 14 - 15 - 16 - 17 - 18 - 19 - 20 - 21 - 22 - 24 - 27 - 30 - 32 mm

 1/2" - 10-12-14-15-17-19 mm

 1/2" - 16, 21 mm

 1/2"

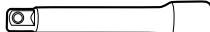
 1/2" - 125, 250 mm

 1/2"

 1/2"



25
years
GUARANTEE

TÜV Rheinland
CERTIFIED

CrV
steel

x32

1/2"

72





Ref.  EAN
08-662 1/3 5907558417364

NEO
TOOLS

 1/2" - 10-11-12-13-14-15-16-17-18 -19-20-21-22-24-27-30-32 mm

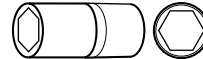
 1/2" - 10-11-12-13-14-15-17-19 mm

 1/2" - 16, 21 mm

 1/2"

 1/2" - 125, 250 mm

 1/2"  1/2"

 1/2" - 5/16"

5/16" - FD8-FD10-FD12
PH1-PH2-PH3-PH4
PZ1-PZ2-PZ3-PZ4
T20-T25-T30-T40-T45-T50-T55
H4-H5-H6-H8-H10-H12-H14



25
years
GUARANTEE

TÜV Rheinland
CERTIFIED

CrV
steel

x58

1/2"

72



















Ref.  EAN
08-663 0/4 5907558417296

Klucze nasadowe

Socket wrenches / Steckschlüssel / Набор сменных головок / Ключи торцевые / Dugókulcskészlet / Trusa tubulare / Nástrčné kľúče / Nástrčné ključice / Nasadni ključiči / Verzlérakció antgaliak / Nomaināmo galvu komplekts / Padrīnīvotmed / Сменная накруйница для ключеве / Nasadni ključeviči / Ključeviči natičakči / Σετ με καρδιάκια / Llaves de vaso / Set di bussolle SuperLock / Chaves tubulares / Clefs à douilles / Dopsleutels

NEO
TOOLS



1/2" - 10-11-12-13-14-15-16-17-18-19
20-21-22-23-24-27 mm

1/4" - 4-5-5.5-6-7-8-10-11-12-13 mm

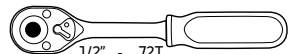

1/2" - 72T
1/4" - 72T

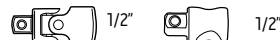

1/2" - 16, 21 mm



1/2" - 125, 250 mm
1/4" - 100 mm



1/4" - 150 mm



1/4"



1,5-2-2,5 mm

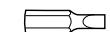

1/4" - TX8, TX10, TX15, TX20, TX25, TX27,
TX30, TX40, PH0, PH1, PH2, PH3,
PZ1, PZ2, PZ3, SL4, SL5.5, SL7, HEX 3,
4, 5, 6, 8, 10, 1/8", 9/64", 5/32",
3/16", 7/32", 1/4", 5/16", SPLINE 6, 8



Ref. 08-673 EAN 5907558421613

NEO
TOOLS



1/2" - 14-15-16-17-18-19-20-22-24-27-30-32 mm

1/4" - 4-4.5-5-5.5-6-7-8-9-10-11-12-13-14 mm

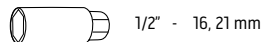

1/2" - 16, 21 mm



1/2" - 72T
1/4" - 72T



1/4" - 150 mm



1/4" - 150 mm



1/2" - 125, 250 mm
1/4" - 50, 100 mm

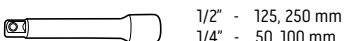

1/4" - 115 mm



8-10-11-12-13-14-17-19-22 mm

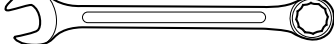

1/2" - 5/16"



1/4" - SL4-SL5.5-SL7
PH1-PH2
PZ1-PZ2
T8-T10-T15-T20-T25-T30
H3-H4-H5-H6

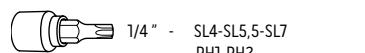

5/16" - SL8-SL10-SL12
PH3-PH4
PZ3-PZ4
T40-T45-T50-T55
H8-H10-H12-H14

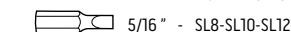

5/16" - SL8-SL10-SL12
PH3-PH4
PZ3-PZ4
T40-T45-T50-T55
H8-H10-H12-H14

5/16" - SL8-SL10-SL12
PH3-PH4
PZ3-PZ4
T40-T45-T50-T55
H8-H10-H12-H14



Ref. 08-672 EAN 5907558421620

Klucze nasadowe

Socket wrenches / Steckschlüssel / Набор сменных головок / Ключи торцевые / Dugókulcskészlet / Trusa tubulara / Nástrčné kľúče / Nástrčné kľúče / Nasadni ključiči / Veržlerakció antgátiai / Nomaināmo galvu komplekts / Padrinvõtmed / Сменная накрайница за ключове / Nasadni ključevci / Ključevci natičaki / Σετ με καρυδάκια / Llaves de vaso / Set di bussole SuperLock / Chaves tubulares / Clefs à douilles / Dopsleutels

NEO
TOOLS

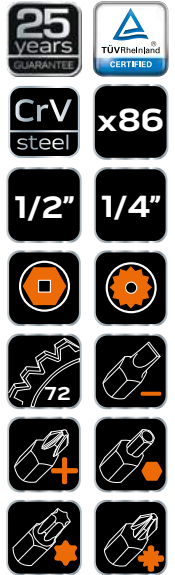
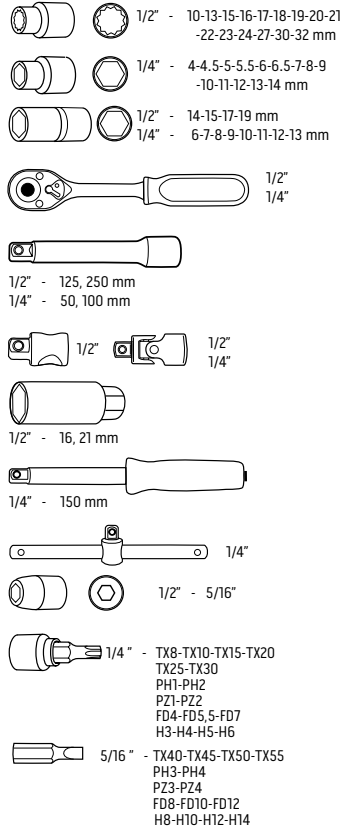

Ref. 08-664 EAN 5907558417302

NEO
TOOLS

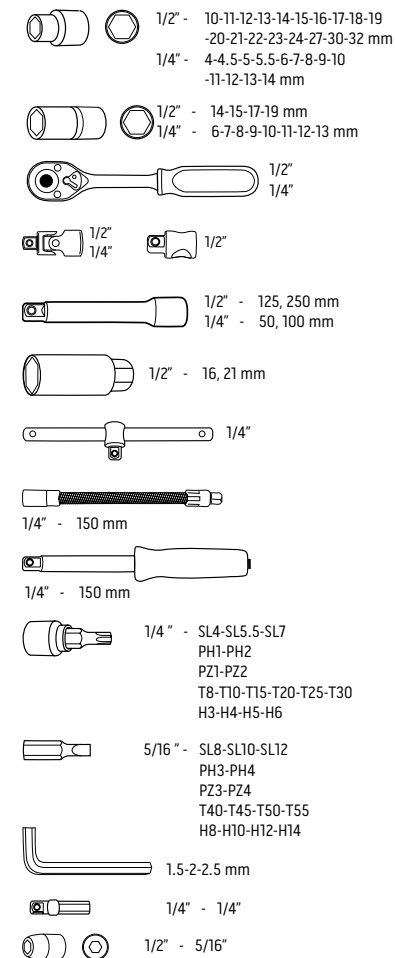

Ref. 08-665 EAN 5907558417371

Klucze nasadowe

Socket wrenches / Steckschlüssel / Набор сменных головок / Ключи торцевые / Dugókulcskészlet / Trusa tubulare / Nástrčné kľúče / Nástrčné kľúče / Nasadni ključji / Verzlérakció antgaliak / Nomināmo galvu komplekts / Padrīnāvētmed / Сменная накруйница за ключове / Nasadni ključevci / Ključevci natikači / Σετ με καρδιάκια / Llaves de vaso / Set di bussole SuperLock / Chaves tubulares / Clefs à douilles / Dopsleutels

NEO
TOOLS

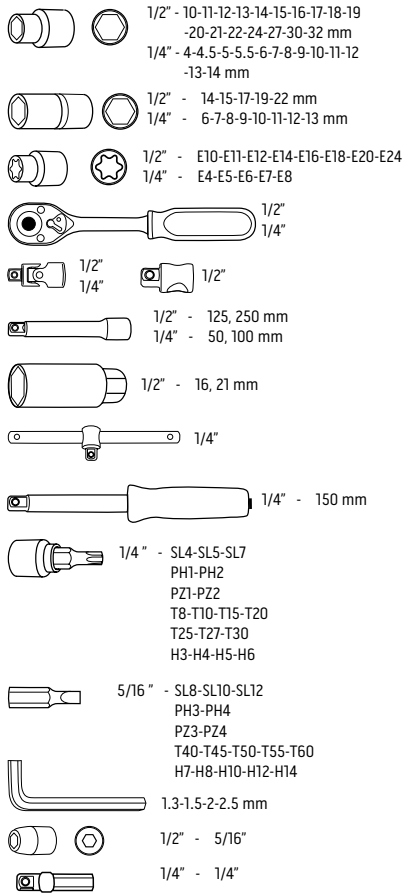

Ref. EAN
08-666 0/4 5907558417340

NEO
TOOLS

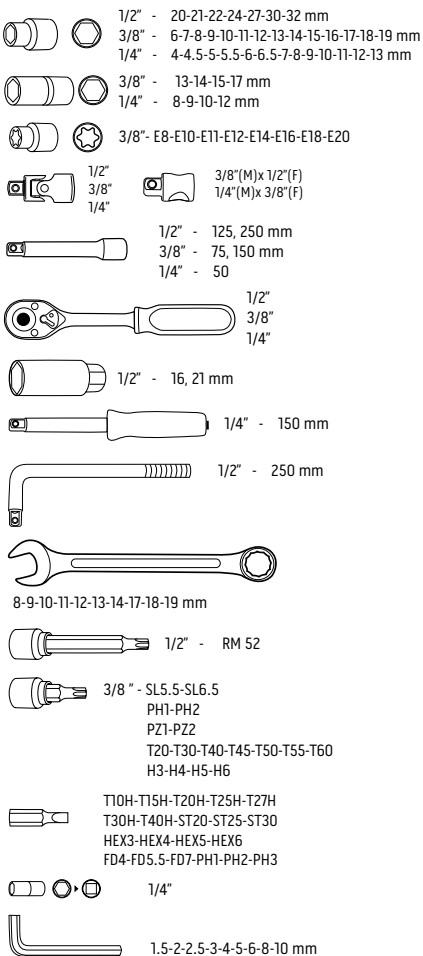

Ref. EAN
08-667 0/2 5907558417333

Klucze nasadowe

Socket wrenches / Steckschlüssel / Набор сменных головок / Ключи торцевой / Dugókulcskészlet / Trusa tubulare / Nástrčné klúče / Nástrčné klúče / Nasadni ključiči / Verzlérakció antgajai / Nomināmo galvu komplekts / Padrunvõtmed / Сменными наконечниками для ключов / Nasadni ključevci / Ključevci natičaki / Σετ με καρυδάκια / Llaves de vaso / Set di bussole SuperLock / Chaves tubulares / Clefs à douilles / Dopsleutels

NEO
TOOLS

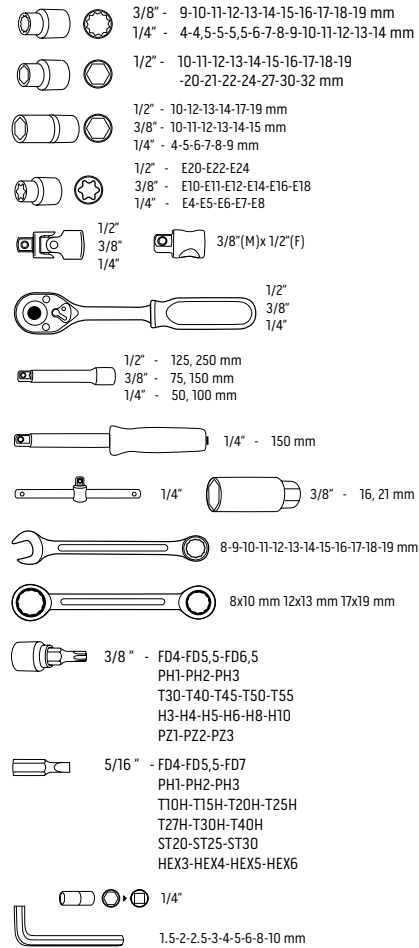

Ref. EAN
08-668 0/2 5907558417326

NEO
TOOLS

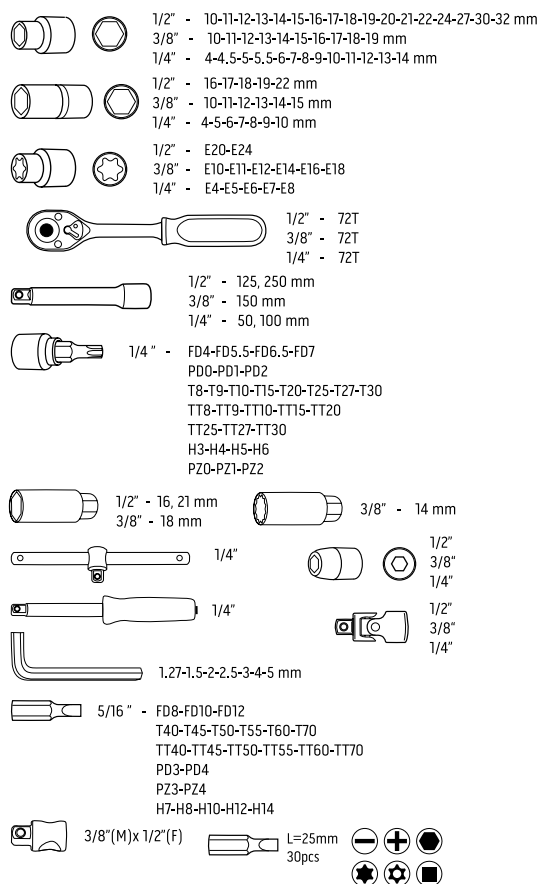

Ref. EAN
08-680 0/2 5907558422146

Klucze nasadowe

Socket wrenches / Steckschlüssel / Набор сменных головок / Ключи торцевые / Dugókulcskészlet / Trusa tubulare / Nástrčné klúče / Nástrčné klúče / Nasadni ključiči / Verzlérakció antgaliak / Nomaināmo galvu komplekts / Padrūnīvotmed / Сменная накруйница за ключове / Nasadni ključevci / Ključevci natičaki / Σετ με καρδιάκια / Llaves de vaso / Set di bussole SuperLock / Chaves tubulares / Clefs à douilles / Dopsleutels

NEO
TOOLS

25
years
GUARANTEE

TÜV Rheinland
CERTIFIED

CrV
steel

x219

1/2"

3/8"

1/4"

72



1/2" - 10-11-12-13-14-15-17-19-20-21-22-24-27-30-32 mm
3/8" - 10-11-12-13-14-15-16-17-18-19 mm
1/4" - 4-4.5-5-5.5-6-7-8-9-10-11-12-13-14 mm

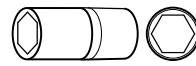

1/2" - 16-17-18-19-22 mm
3/8" - 10-11-12-13-14-15 mm
1/4" - 4-5-6-7-8-9-10 mm



1/2" - E18- E20-E22-E24
3/8" - E8-E10-E12-E14-E16
1/4" - E4-E5-E6-E7-E8



1/2" - 72T; 3/8" - 72T; 1/4" - 72T

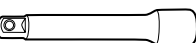

1/2" - 125, 250 mm
3/8" - 125 mm
1/4" - 50, 100 mm



1/2" - 16, 21 mm
3/8" - 18 mm



1/2" - T55-T60
1/4" - SL4-SL5.5-SL6.5-SL7
PZ1-PZ2-PZ3, PH1-PH2-PH3
T8-T9-T10-T15-T20-T25-T27-T30
TT8-TT9-TT10-TT15-TT20-TT25-TT27-TT30
H3-H4-H5-H6

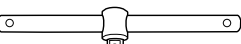

1/4" - 115 mm



1/4" - 210 mm



1/4" - 150 mm



8-9-10-11-12-13-14-15-16-17-18-19 mm



5/16" - T25-T27-T30-T35-T40-T45-T50
H5.5-H6-H7-H8, SL6-SL6.5-SL8
PH3-PH4, PZ3-PZ4, M5-M6-M8-M10



1/4" - H3, H4, H5, H6, H3, H4, H5, H6
PH1, PH2, PZ1, PZ2, T8, T10, T15, T20,
T25, TT10, TT15, TT20, TT25, TT40,
TT8, TT10, TT20, TT25, M5, M6,
M8, SL4, SL5, SL5.5, TRI-WING 1, 2, 3,
TORQ 6, 8, 10, S1, S2, SL4, SL6, SL8



1/2" - 5/16"
3/8" - 5/16"
1/4" - 5/16"

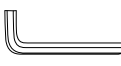

(1,27-1,5-2mm) x 2
2,5-3-4-5 mm

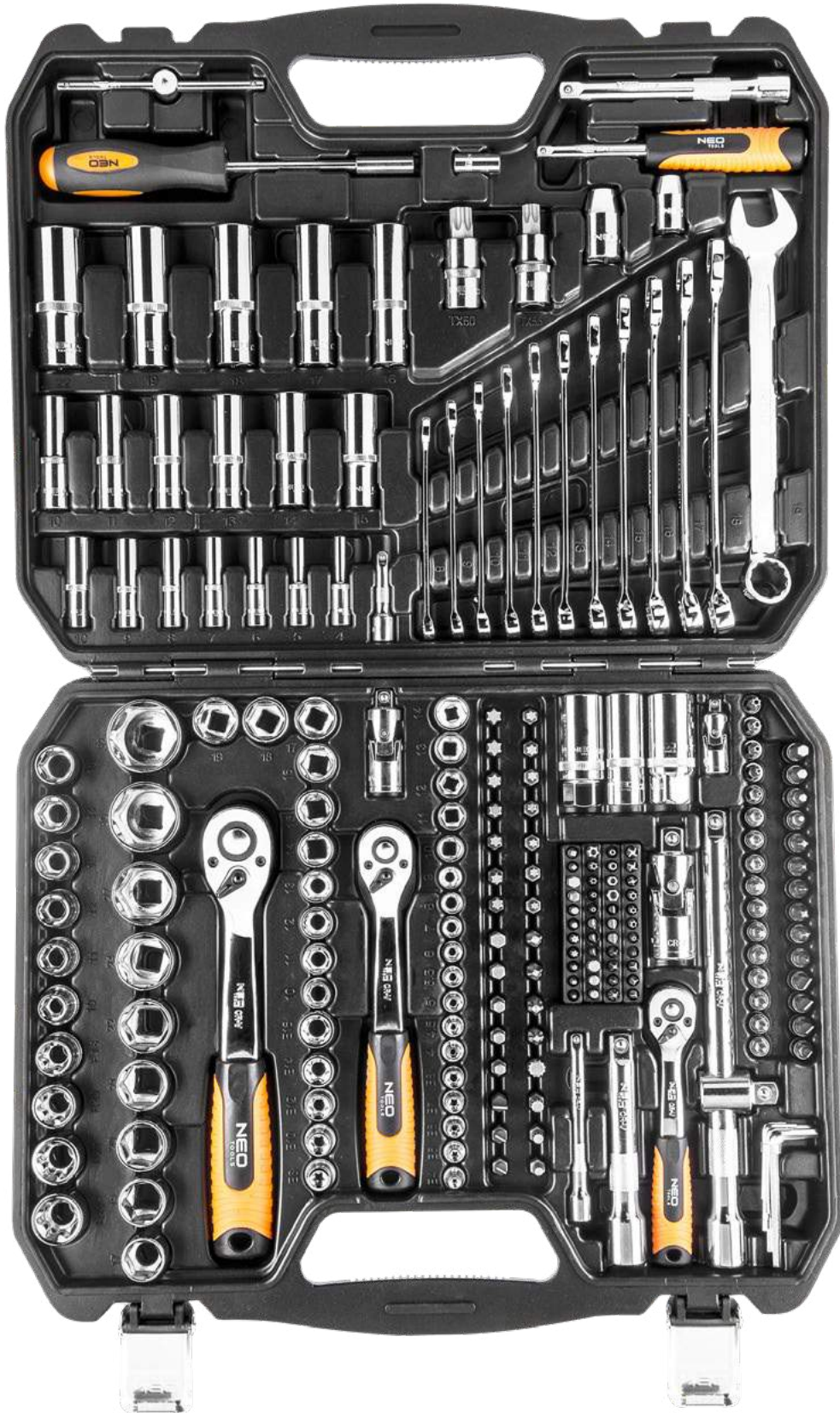

Ref. EAN

08-671 0/2 5907558421637

Ключи nasadowe

Socket wrenches / Steckschlüssel / Набор сменных головок / Ключи торцевой / Dugókulcskészlet / Trusa tubulara / Nástrčné kľúče / Nástrčné klíče / Nasadni ključiči / Veržlerakció antgajai / Nomaināmo galvu komplekts / Padrinvõtmed / Сменная накрайница за ключове / Nasadni ključevci / Ključevci natikači / Σετ με καρυδάκια / Llaves de vaso / Set di bussole SuperLock / Chaves tubulares / Clefs à douilles / Dopsleutels

NEO
TOOLS



1/2" - 10-13-15-16-17-18-19-20-21-22-23-24-27-30-32 mm
7/16", 1/2", 9/16", 5/8", 11/16", 3/4", 13/16", 7/8"

3/8" - 10-11-12-13-14-15-16-17-18-19 mm

1/4" - 3.5-4-4.5-5-5.5-6-6.5-7-8-9-10-11-12-13-14 mm
3/8", 11/32", 5/16", 9/32", 1/4", 5/32", 3/16"



1/2" - 15-16-17-18-19-22 mm

3/8" - 10-11-12-13-14-15 mm

1/4" - 4-5-6-7-8-9-10 mm



1/2" - E16-E18-E20-E22-E24

3/8" - E10-E11-E12-E14

1/4" - E4-E5-E6-E7-E8

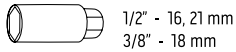

1/2" - 16, 21 mm
3/8" - 18 mm

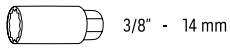

3/8" - 14 mm

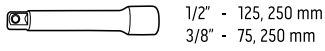

1/2" - 125, 250 mm
3/8" - 75, 250 mm



1/4" - 50, 100 mm

9pcs

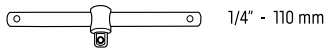

1/4" - 110 mm



1/4"



1/4"



1/4"

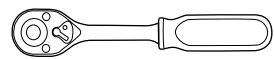

1/2" - 72T
3/8" - 72T
1/4" - 72T

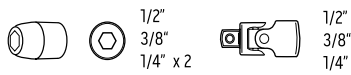

1/2" - 72T
3/8" - 72T
1/4" x 2 - 72T
1/4" - 72T



1/2" - 72T
3/8" - 72T



1/4" - 72T
1/4"x1/4" - 72T
1/4"x3/8" - 72T

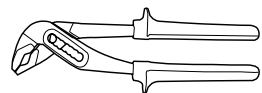
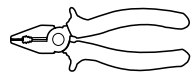

8-9-10-11-12-13-14-15-17-19-22 mm



L=75mm
8pcs



5/16" L=30mm
24pcs



L=25mm
60pcs



Ref. EAN
08-681 1/2 5907558422153

Klucze nasadowe

Socket wrenches / Steckschlüssel / Набор сменных головок / Ключи торцевые / Dugókulcskészlet / Trusa tubulare / Nástrčné kľúče / Nástrčné kľúče / Nasadni ključiči / Verzlérakció antgai / Nomināmo galvu komplekts / Padrūnviņtmed / Сменная накрайница за ключове / Nasadni ključevci / Ključevci natičaki / Σετ με καρδιάκια / Llaves de vaso / Set di bussolle SuperLock / Chaves tubulares / Clefs à douilles / Dopsleutels

NEO
TOOLS

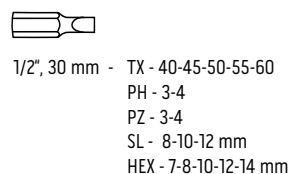
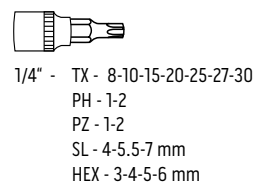
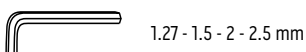
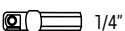
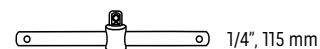
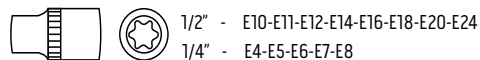
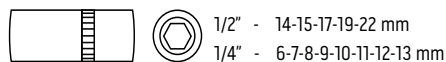
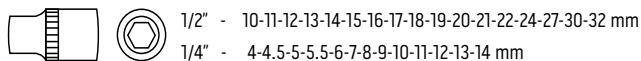

Ref. EAN
08-910 1/4 5907558442113

Klucze nasadowe

Socket wrenches / Steckschlüssel / Набор сменных головок / Ключи торцевые / Dugókulcskészlet / Trusa tubulare / Nástrčné kľúče / Nástrčné kľúče / Nasadni ključiči / Veržlerakció antgátiai / Nomaināmo galvu komplekts / Padrunvõtmed / Сменными наконечниками за ключовые / Nasadni ključeviči / Ključeviči natičakči / Σετ με καρυδάκια / Llaves de vaso / Set di bussole SuperLock / Chaves tubulares / Clefs à douilles / Dopsleutels

NEO
TOOLS



1/2" - 10-11-12-13-14-15-17-19-22-24-27-30-32 mm
1/4" - 4-5-6-7-8-9-10-11-12 mm

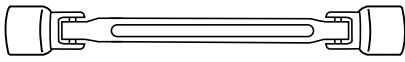

8-9 / 10-11 / 12-13 / 14-15 mm

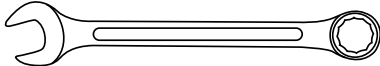

7-8-9-10-11-12-13-14-15-17-19 mm



1/2", 72T
1/4", 72T

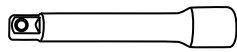

1/2" - 125, 250 mm
1/4" - 100 mm



1/2"
1/4"



1/2" - 3/8"



1/4"

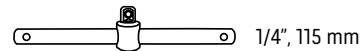

1/4", 115 mm



1/2" - 16, 21 mm

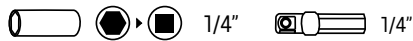

1/4" 1/4"

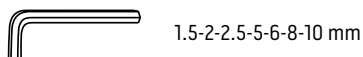

1.5-2-2.5-5-6-8-10 mm



1/2", 30 mm - TX - 10-15-20-25-30
PH - 0-1-2-3
PZ - 1-2-3
SL - 3-4-5-5-7 mm
HEX - 2-3-4-5-6 mm



Ref. EAN
08-915 1/4 5907558442120

Klucze nasadowe

Socket wrenches / Steckschlüssel / Набор сменных головок / Ключи торцевой / Dugókulcskészlet / Trusa tubulare / Nástrčné kľúče / Nástrčné ključice / Nasadni ključiči / Veržlerakció antgajai / Nomaināmo galvu komplekts / Padrunvõtmed / Сменная накруйница за ключове / Nasadni ključevci / Ključevci natičaki / Σετ με καρδιάκια / Llaves de vaso / Set di bussola SuperLock / Chaves tubulares / Clefs à douilles / Dopsleutels

NEO
TOOLS



1/4" - 5, 5.5, 6, 7, 8, 9, 10, 11, 12, 13, 14 mm



1/4" - 4, 5, 6, 7, 8 mm
PH1, PH2, PH3,
PZ1, PZ3, PZ2x2
TT8, TT9, TT10, TT15, TT20, TT25,
TT27, TT30, TT40
H2, H2.5, H3, H4, H5, H6, H7, H8

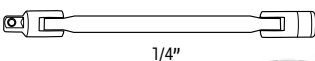

1/4"



Ref. 08-603
EAN 5907558409307



NEO
TOOLS



5-6-8-9-10-12 mm

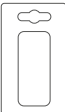

Ref. 09-570
EAN 5907558450453



TOPEX

1/4" - 4; 5; 5.5; 6; 7; 8; 10; 11; 12; 13 mm

1/4" - 6; 7; 8; 10; 12; 13 mm

1/4" - 150 mm

1/4" - 50; 100 mm

1.5; 2; 2.5 mm

4; 5 mm
PH 1; PH 2
PZ 1; PZ 2
H5; H6
T10; T15; T20

1/4" - 40 mm

1/4" M x 3/8" F

L - 30 mm

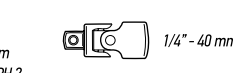

TOPEX

1/4"

1/4" - 4; 5; 6; 7; 8; 9; 10; 11; 12; 13 mm



Ref. 38D650
EAN 5902062386502



TOPEX

1/2"

1/2" - 10; 12; 13; 14; 15; 16; 17; 19; 21; 24 mm



Ref. 38D652
EAN 5902062386526



TOPEX

1/4" - 4; 4.5; 5; 5.5; 6; 7; 8; 10; 11; 12; 13; 14 mm

1/4" - 150 mm

1/4" - 50; 100 mm

1/4" - 150 mm

1/4" - 110 mm

1/4" - 150 mm

1/4" - 40 mm

1.5; 2; 2.5 mm

4; 5.5; 7 mm
PH 1; PH 2; PH 3
PZ 1; PZ 2; PZ 3
L - 40 mm

H3; H4; H5; H6; H7; H8
T10; T15; T20; T25; T30; T40

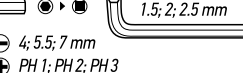
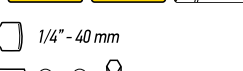

Ref. 38D669
EAN 5902062042552

36
elements



Ref. 38D640
EAN 5902062386403

46
elements

Klucze nasadowe

Socket wrenches / Steckschlüssel / Набор сменных головок / Ключи торцевой / Dugókulcskészlet / Trusa tubulare / Nástrčné kľúče / Nástrčné kľúče / Nasadni ključiči / Veržlerakció antgaliak / Nomaināmo galvu komplekts / Padrunvõtmed / Сменная накрайница за ключове / Nasadni ključevci / Ključevci natičkači / Σετ με καρβύδια / Llaves de vaso / Set di bussole SuperLock / Chaves tubulares / Clefs à douilles / Dopsleutels

TOPEX

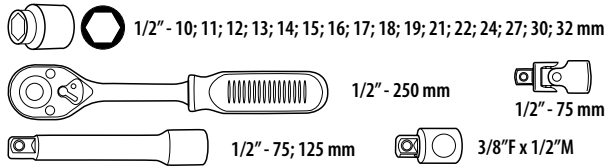

1/2"

21
elements



Ref. 38D642
EAN 5902062386427

TOPEX

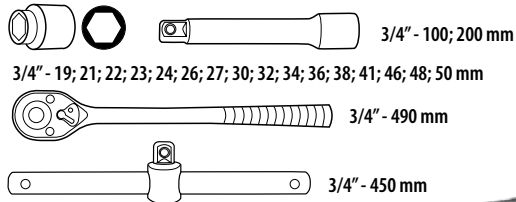

3/4"

20
elements



Ref. 38D296
EAN 5902062041784

TOP TOOLS



x23

1/4"

Ref. 38D505
EAN 5902062036988

TOPEX



CrV

1/2"

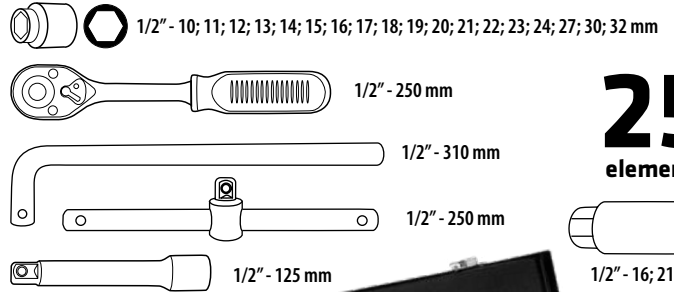

25
elements

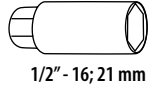

Ref. 38D850
EAN 5902062017307

TOP TOOLS



x12

1/4"

Ref. 38D147
EAN 5902062036780

TOP TOOLS



x8

3/8"

Ref. 38D142
EAN 5902062381422

TOP TOOLS



x8

1/2"

Ref. 38D143
EAN 5902062381439

Klucze nasadowe

Socket wrenches / Steckschlüssel / Набор сменных головок / Ключи торцевые / Dugókulcskészlet / Trusa tubulare / Nástrčné kľúče / Nástrčné kľúče / Nasadni ključiči / Veržlerakció antigaljai / Nomināmo galvu komplekts / Padrunvõtmed / Сменная накладка на ключевое / Nasadni ključevci / Ključevci natikači / Σετ με καριδάκια / Llaves de vaso / Set di bussole SuperLock / Chaves tubulares / Clefs à douilles / Dopsleutels

TOP TOOLS  1/4" - 4, 5, 6, 7, 8, 9, 10, 11, 12, 13, 14 mm

x15

 1/4" - 50, 150 mm

1/4"

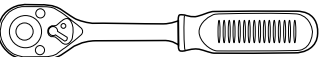
 1/4"



 1/4"



Ref.  EAN
38D525 0/10 5902062037688

TOP TOOLS  1/4" - 4, 5, 6, 7, 8, 9 mm
 3/8" - 10, 11, 12, 13, 14, 15, 17, 19 mm

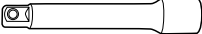
x20

 3/8" - 70, 140 mm  1/4" F x 3/8" M

1/4"

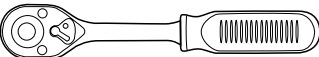

 3/8"  3/8" - 21 mm

3/8"



 1/4"



Ref.  EAN
38D520 0/10 5902062034052

TOP TOOLS  1/4" - 4, 5, 6, 7, 8, 9, 10, 11, 13 mm
 1/2" - 10, 11, 12, 13, 14, 15, 16, 17, 19, 22, 24, 27, 30 mm

x53

 1/4" - 75 mm
 1/2" - 110, 250 mm

1/2"

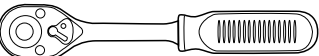
 1/4", 1/2"

 
1/4" 1/4"

 
1/4" 1/4"

 1/4"

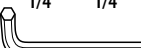
 1.5, 2, 2.5, 3, 4, 5, 6 mm

SL4, SL5, SL6, PH1, PH2, PZ1,
PZ2, H3, H4, H5, H6, T10, T15, T20



Ref.  EAN
38D530 0/4 5902062034069

TOP TOOLS  1/2" - 8, 9, 10, 11, 12, 13, 14, 15, 16, 17,
18, 19, 20, 21, 22, 24, 27, 32 mm

x47

 1/2" - 120, 250 mm

1/2"

 1/2"

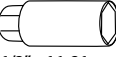
 1/2" - 16, 21 mm

1/4"

 1/4"

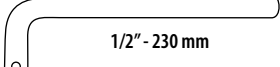
 1/2" - 230 mm

 1/2" - 240 mm

SL3, SL4, SL5, SL6, PH0, PH1, PH2, PH3, PZ0,
PZ1, PZ2, PZ2 H3, H4, H5, H6, T10, T15, T20, T27



Ref.  EAN
38D550 0/4 5902062037718

Klucze nasadowe

Socket wrenches / Steckschlüssel / Набор сменных головок / Ключи торцевые / Dugókulcskészlet / Trusa tubulare / Nástrčné kľúče / Nástrčné kľúče / Nasadni ključiči / Veržlerákció antgaliái / Nomināmo galvu komplekts / Padrinvõtmed / Сменная накруйница за ключове / Nasadni ključeviči / Ključeviči natikači / Σετ με καρβόδια / Llaves de vaso / Set di bussole SuperLock / Chaves tubulares / Clefs à douilles / Dopseultels

TOP TOOLS

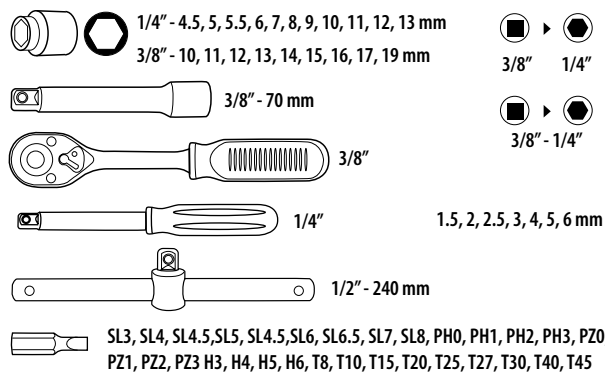

x63

1/4"

3/8"

TOP TOOLS

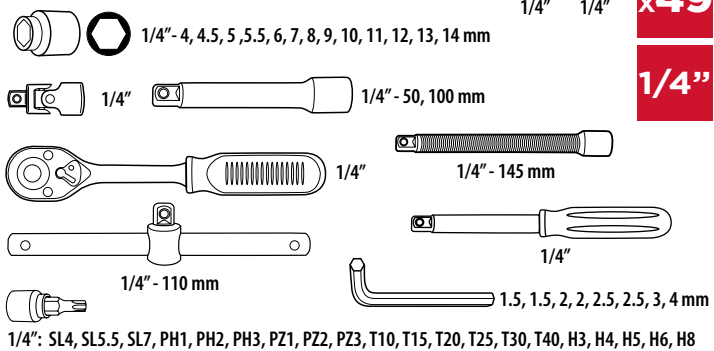

x49

1/4"



Ref. EAN
38D515 0/10 5902062037701



Ref. EAN
38D570 0/10 5902062043795

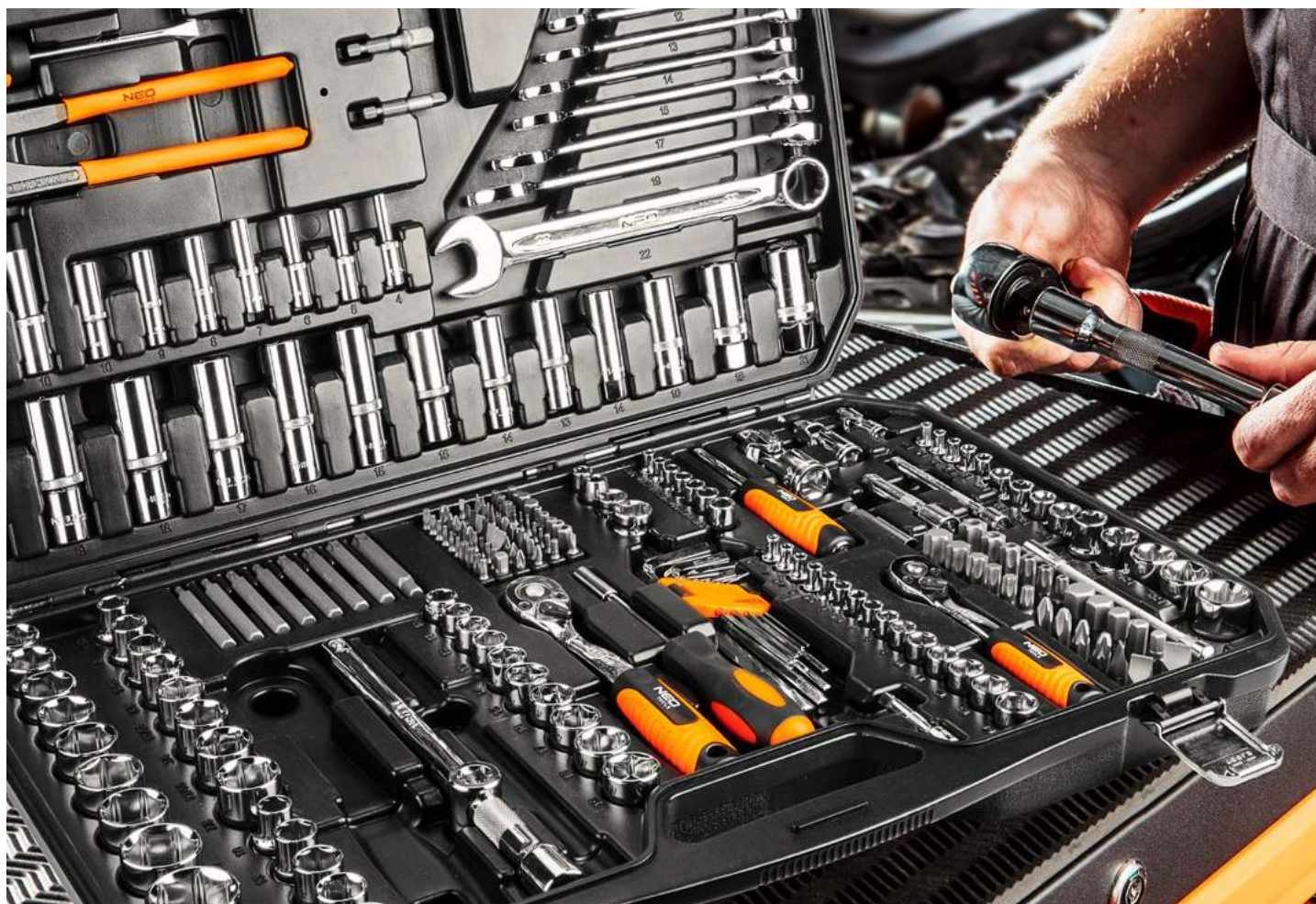

Zestaw narzędzi

Tool and socket set / Werkzeugsatz / Набор инструментов / Инструмент з насадками, набор / Szerszámkészlet / Set scule de grădină / Sada nářadí / Súprava náradia kombi / Garnitura orodij / Įrankių komplektas / Instrumentu komplekts / Тööriistade ja radrunite komplekt / Комплект инструменти / Set alata / Gedora set / Συλλογή εργαλείων / Juego de herramientas / Set di attrezzi / Kit de ferramentas / Jeu d'outils / Gereedschapset

NEO
TOOLS



1/2" - 10-11-12-13-14-15-17-19-22-24-27-30-32 mm
1/4" - 4-5-6-7-8-9-10-11-12-13 mm

1/4" - 9-10-11-12-13 mm

1/2" - 16, 21 mm

1/2", 72T
1/4", 72T

1/2" - 125 mm
1/4" - 75 mm

1/2"
1/4" 1.5-2-2.5 mm
1/4"

8-10-11-12-13-14-15-17-19 mm

1/4" 1/4"

PZ 2x150 mm
SL 6.5x100 mm / SL 5.5x38 mm /
PH 2x100 mm / PH1x38 mm

250 mm

180 mm

225 mm

x26
12V

1/4 - TX - 15-20-30
PH - 1-2-3
SL - 4-5-5-7 mm
HEX - 3-4-5-6 mm

400 g



Ref. EAN
08-920 1/2 5907558442137

Zestaw narzędzi

Tool and socket set / Werkzeugsatz / Набор инструментов / Инструмент з насадками, набор / Szerszámkészlet / Set scule de grădină / Sada nářadí / Súprava nářadia kombi / Garnitura orodij / Įrankių komplektas / Instrumentu komplekts / Тööriistade ja radrunite komplekt / Комплект инструментов / Set alata / Gedora set / Συλλογή εργαλείων / Juego de herramientas / Set di attrezzi / Kit de ferramentas / Jeu d'outils / Gereedschapsset

TOPEX

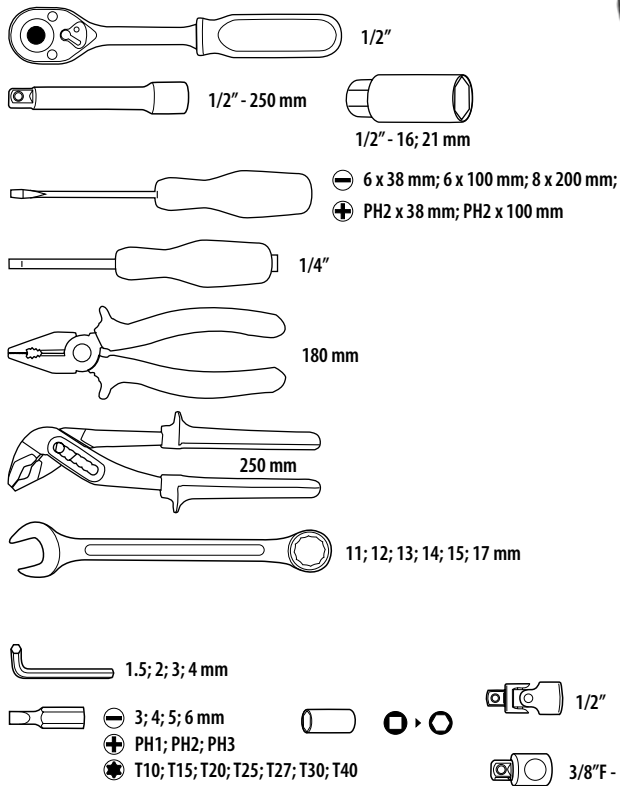

1/2"

1/4"

56
elements

Ref.	☒	EAN
38D224	0/3	5902062008640

TOPEX

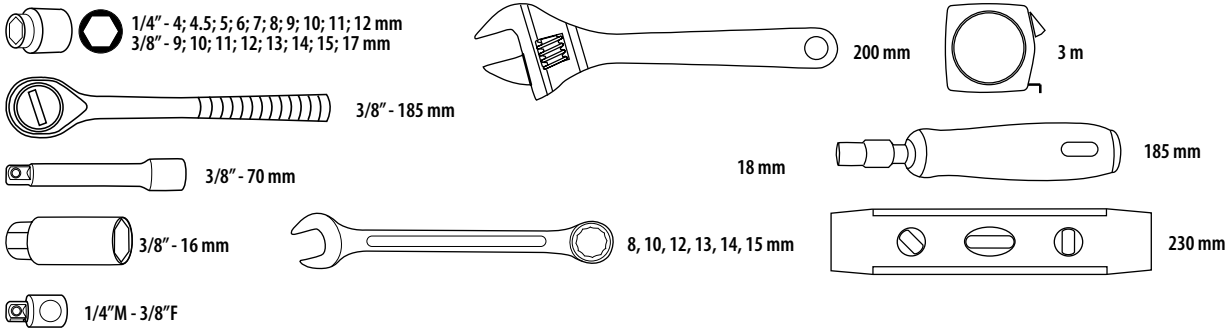

1/4"

3/8"

135
elements

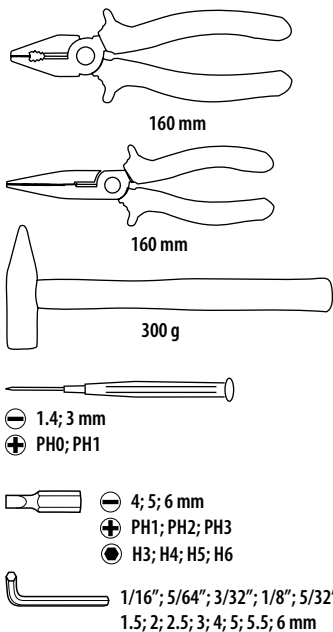

Ref.	☒	EAN
38D215	0/4	5902062044709

Zestaw narzędzi

Tool and socket set / Werkzeugsatz / Набор инструментов / Инструмент з насадками, набір / Szerszámkészlet / Set scule de grădină / Sada nářadí / Súprava nářadia kombi / Garnitura orodij / Įrankių komplektas / Instrumentu komplekts / Тööriistade ja padrunite komplekt / Комплект инструментов / Set alata / Gedora set / Συλλογή εργαλείων / Juego de herramientas / Set di attrezzi / Kit de ferramentas / Jeu d'outils / Gereedschapsset

TOP TOOLS

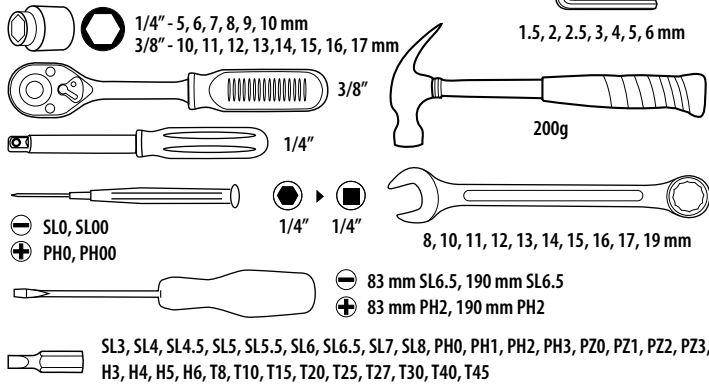

x73
1/4"
3/8"

Ref. 38D500 EAN 5902062034038

TOP TOOLS

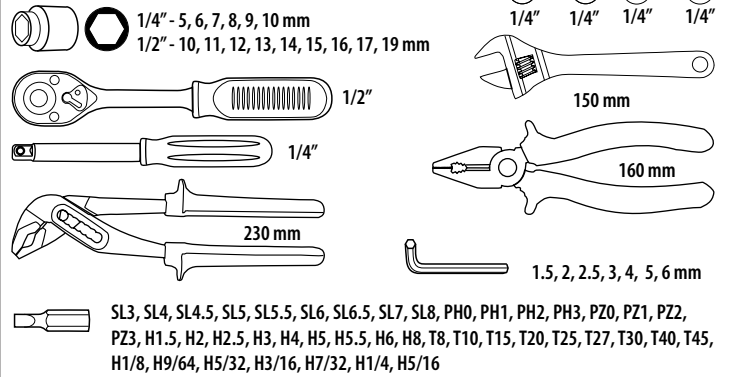

x81
1/2"
1/4"

Ref. 38D510 EAN 5902062034045

TOP TOOLS

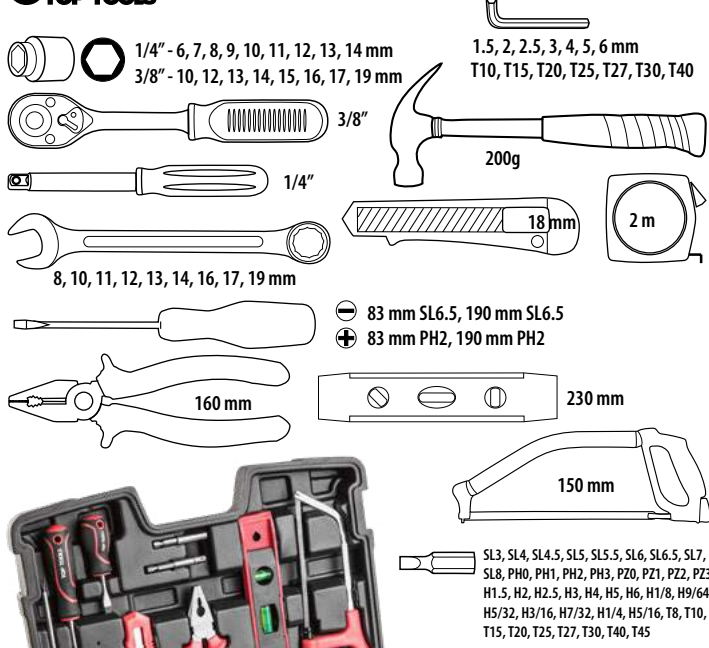

x100
1/4"
3/8"

Ref. 38D535 EAN 5902062037695

TOP TOOLS

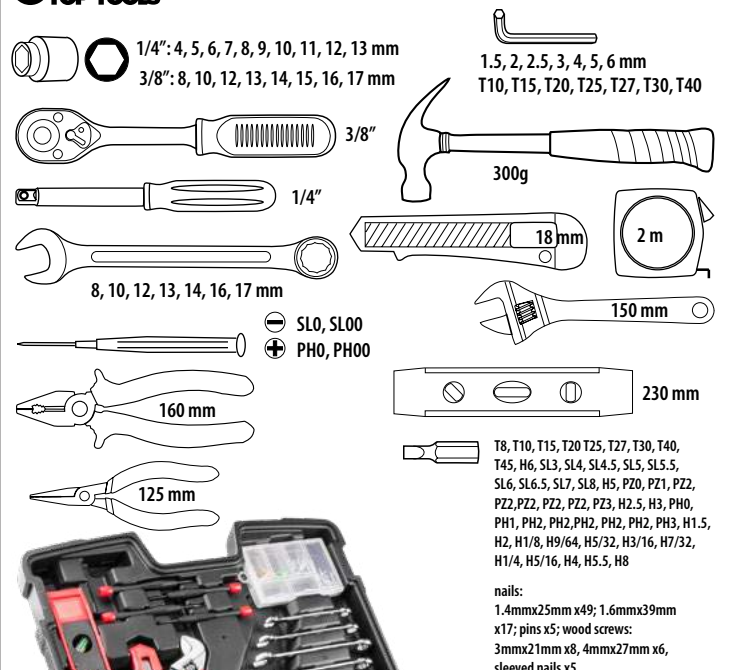

1/4"
3/8"
x194

Ref. 38D545 EAN 590206204955

Końcówka Spline na nasadce

Spline bit / Spline-Endstück / Наконечник Spline / Наконечник „Spline” / Spline bit / Punct Spline / Nástavec Spline / Nástavec Spline / Nastavec Spline / Antgalis Spline / Uzgalis Spline / Spline-otsak / Накрайник Spline / Nastavak Spline / Nastavak Spline / Μύτη Spline / Punta Spline / Inserto Spline su bussola / Ponteiro Spline / Embout Spline / Spline eindstuk

NEO
TOOLS



Ref.	Info	L[mm]	☒	EAN
08-730	M5	55	12/144	5907558411911
08-731	M6	55	12/144	5907558411928
08-732	M8	55	12/144	5907558411935
08-733	M10	55	12/144	5907558411942
08-734	M12	55	12/160	5907558411959
08-735	M14	55	12/160	5907558411966
08-736	M16	55	12/144	5907558411973

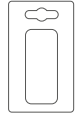

NEO
TOOLS

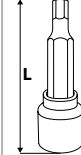

Ref.	Info	L[mm]	☒	EAN
08-740	M5	100	12/96	5907558411980
08-741	M6	100	12/96	5907558411997
08-742	M8	100	12/96	5907558412000
08-743	M10	100	12/96	5907558412017
08-744	M12	100	12/96	5907558412024
08-745	M14	100	12/96	5907558412031
08-746	M16	100	12/96	5907558412048

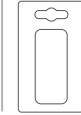

Końcówki sześciokątne na nasadce

Hexagonal bits on socket / Sechskanteinsätze auf Aufsatz / Головки шестигранные с насадкой / Наконечники шестигранные на насадку / Imbusz bit / Trusa capete tubulare cu antrenor / Koncovky šestihřanné na nástavce / Šestihřanné koncovky na nástavce / Šestkotni nastavki za nasadni ključ / Šešiakontari antgaliai su laikikliu / Nomainā mā galva ar sešstūra uzgaļiem / Kuuskantsakud padrūni / Шестьо̀гльни накрайници на наставката / Šesterokutni nastavci na kapici / Šestougaoni nastavci za nasadke / Καρβόκι με μύτης εξήγωνες / Vasos destornilladores hexagonales / Inserto esagonale con bussola / Ponteiros hexagonais no bico / Embouts à 6 pans sur ajutage / Zeskant eindstukken op dop

NEO
TOOLS

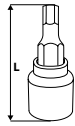

Ref.	Info	L[mm]	☒	EAN
08-770	H5	55	20/140	5907558409765
08-771	H6	55	12/144	5907558409772
08-772	H7	55	20/160	5907558409789
08-773	H8	55	12/144	5907558409796
08-774	H10	55	20/160	5907558409802
08-775	H12	55	20/160	5907558409819
08-776	H14	55	20/160	5907558409826
08-777	H17	55	20/160	5907558409833
08-778	H19	55	12/96	5907558409840

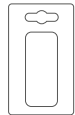

NEO
TOOLS

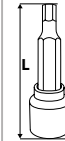

Ref.	Info	L[mm]	☒	EAN
08-780	H5	100	12/96	5907558409857
08-781	H6	100	20/100	5907558409864
08-782	H7	100	12/96	5907558409871
08-783	H8	100	20/100	5907558409888
08-784	H10	100	20/100	5907558409895

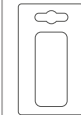

NEO
TOOLS

● H4, H5, H6, H7, H8, H10, H12, H14, H17

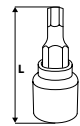

25
years
GUARANTEE

TÜV Rheinland
CERTIFIED

S2
steel

CrV
steel

1/2"

x9



NEO
TOOLS

● H4, H5, H6, H7, H8, H10, H12, H14, H17

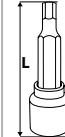

25
years
GUARANTEE

TÜV Rheinland
CERTIFIED

S2
steel

CrV
steel

1/2"

x9



Ref.	L[mm]	☒	EAN
08-705	55	0/12	5907558409253

Ref.	L[mm]	☒	EAN
08-706	100	0/12	5907558409260

Końcówki Torx na nasadce

Torx bit on socket / Torx-Einsatz auf Aufsatz / Головка сменная с насадкой Torx / Наконечник «Torx» на насадке / Torxbit / Cap tubulara cu antrenor torx / Концовка Torx на наставке / Концовка Torx на наставке / Nastavek Torx za nasadni ključ / Torcinis antgalis su laikikliu / Nomaināma galva ar Torx uzgali / Torx-otsak padrunil / Накрайник Torx на наставкама / Nastavak Torx на капци / Nastavak Torx za nasadke / Καρυδάκι με μύτη Torx / Vaso torx / Inserto Torx con bussola / Ponteiros Torx no bico / Embouts Torx sur ajutage / Trox eindstuk op dop

NEO
TOOLS

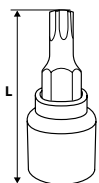

Ref.	Info	L[mm]	☒	EAN
08-750	T20	55	12/144	5907558409604
08-751	T25	55	12/144	5907558409611
08-752	T27	55	12/144	5907558409628
08-753	T30	55	12/144	5907558409635
08-754	T40	55	20/160	5907558409642
08-755	T45	55	20/160	5907558409659
08-756	T50	55	12/144	5907558409666
08-757	T55	55	20/160	5907558409673
08-758	T60	55	12/144	5907558417388
08-759	T70	55	12/144	5907558417395

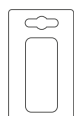

NEO
TOOLS

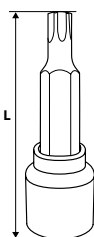

Ref.	Info	L[mm]	☒	EAN
08-760	T20	100	12/96	5907558409680
08-761	T25	100	20/100	5907558409697
08-762	T27	100	20/100	5907558409703
08-763	T30	100	20/100	5907558409710
08-764	T40	100	12/96	5907558409727
08-765	T45	100	20/100	5907558409734
08-766	T50	100	20/100	5907558409741
08-767	T55	100	20/100	5907558409758

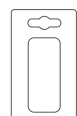

NEO
TOOLS

★ T20, T25, T27, T30, T40, T45, T50, T55, T60



NEO
TOOLS

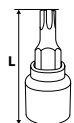

H6, H7, H8, H10, H12
T25, T30, T40, T45, T50, T60
M6, M8, M10, M12, M14

T20, T25, T27, T30, T40, T45, T50, T60

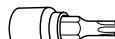

H5, H6, H7, H8, H10, H12, H14, H17, H19
T20, T25, T27, T30, T40, T45, T50, T55, T60, T70
M5, M6, M8, M10

Ref.	L[mm]	☒	EAN
08-707	55	0/12	5907558409277

NEO
TOOLS

★ T20, T25, T27, T30, T40, T45, T50, T55, T60

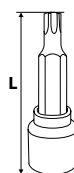

Ref.	L[mm]	☒	EAN
08-708	100	0/12	5907558409284



Ref.	☒	EAN
08-713	0/3	5907558420180

Końcówki Torx na nasadce

Torx bit on socket / Torx-Einsatz auf Aufsatz / Головка сменная с насадкой Torx / Наконечник «Torx» на насадку / Torx bit / Cap tubulara cu antrenor torx / Концовка Torx на наставку / Концовка Torx на наставку / Nastavek Torx za nasadni ključ / Torcinis antgalis su laikikliu / Nomaināmā galva ar Torx uzgali / Torx-otsak padrunil / Накрайник Torx на наставка / Nastavak Torx na kapici / Nastavak Torx za nasadke / Καρυδάκι με μύτη Torx / Vaso torx / Inserto Torx con bussola / Ponteiros Torx no bico / Embouts Torx sur ajutage / Torx eindstuk op dop

TOPEX

CrV 1/2" 

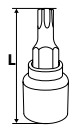

Ref.	W [mm]	L [mm]	☒	EAN
38D804	T30	60	12/96	5902062388049
38D805	T40	60	12/96	5902062388056
38D806	T45	60	12/96	5902062388063
38D807	T50	60	12/96	5902062388070
38D808	T55	60	12/96	5902062388087
38D809	T60	60	12/96	5902062388094
38D810	T70	60	12/96	5902062388100

TOPEX

CrV x7 1/4" 

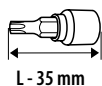

TT10; TT15; TT20; TT25; TT27; TT30; TT40

L - 35 mm

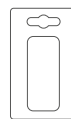

Ref.	☒	EAN
39D378	25/75	5902062393784

TOPEX

x12 1/4" 3/8" 1/2" 



1/4" - T10, T15, T20, T27, T30

3/8" - T40, T45, T47, T50, T55

1/2" - T60

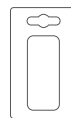

Ref.	☒	EAN
39D342	6/24	5902062008671

Nasadki Torx

Torx sockets / Torx-Aufsätze / Головки сменные Torx / Насадки «Torx» / Torx kulcs / Tubulara cu capat torx / Наставке Torx / Наставке Torx / Nasadni ključii Torx / Torciniai antgaliai / Torx nomaināmas galviņas / Torx-padrunid / Наставки Torx / Карпце Torx / Nasadke Torx / Ανταλλακτικές μύτες Torx / Vasos torx / Bussola Torx / Bocais Torx / Douilles Torx / Torx doppen

NEO TOOLS

25 years GUARANTEE

TÜV Rheinland CERTIFIED

CrV steel

x9 

1/2" 



E10, E11, E12, E14, E16, E18, E20, E22, E24

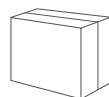

Ref.	☒	EAN
08-649	0/15	5907558417074

Końcówki i nasadki torx

Torx bits and socket set / Torx-Aufsätze / Наконечники и головки торцевые Torx / Набор жпал та насадок «torx» / Torx kulcskészlet / Set canule "torx" și fixări / Bity a nástavce Torx / Súprava klúčov torx / Garnitura nastavkov z vpenjalom / Antgalių Torx ir galvučių rinkinys / Torx atslėgu un mucīņu komplekts / "Torx" otsikute ja padrunite komplekt / Вложки и накраїнуци / Set Nasadnih ključeva I biceva / Set biceva I gedora / Συλλογή από μύτες και καρυδάκια / Puntas destornilladoras y vasos TORX / Inserti Torx / Ponteiros e Bocais Torx / Embouts et douilles Torx / Torx eindstukken en doppen

NEO TOOLS

TÜV Rheinland CERTIFIED

CrV steel

3/8" 

E4, E5, E6, E7, E8, E10, E11, E12, E14, E16, E18, E20
T10, T15, T20, T25, T27, T30, T40, T45, T50, T55, T60
TT10, TT15, TT20, TT25, TT27, TT30, TT40, TT45, TT50, TT55

S2 steel

x34 





Ref.	☒	EAN
08-711	0/12	5907558417111

TOPEX

TORX 

x19 

CrV 

1/2" 

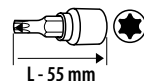

L - 55 mm

T20; T25; T27; T30; T40;
T45; T50; T55; T60; T70



E10; E11; E12; E14; E16;
E18; E20; E22; E24



Ref.	☒	EAN
39D379	0/10	5902062393791

Końcówki wkrętakowe

Driver bits / Einsätze für Schraubendreher / Насадки / Наконечники викрутки / Dugókulcs bitkészlet / Set biti / Šroubovákové nástavce / Skrutkovacie nástavce / Nastavki za izvijače / Atsuktuvo antgaliai / Skrūvgrieža uzgaļi / Kravikeerajaotsakud / Накрайници за отвёртка / Nastavci za odvijač / Nastavci za odvijač / Καταβιδόμετες / Puntas destornilladoras / Inserti lunghi e corti / Ponteiros Chave de fenda / Embouts de tournevis / Schroeveendraaiereindstukken

NEO
TOOLS

H7, H10, H11, H13, H14, H17, H19, H22, H24
TS10, TS15, TS20, TS25, TS27, TS30, TS40, TS45, TS50
T30, T40, T45, T50, T55, T60, T70, T80
M9, M10, M12, M14, M16
R7, R8, R9, R10
H5



Ref.	☒	EAN
08-710	0/3	5907558417104

NEO
TOOLS

± 10 mm
L 30 mm



3/8" ▶ 10 mm
1/2" ▶ 10 mm

± 10 mm

L 75 mm

- 30 mm: T20, T25, T30, T40, T45, T50, T55
75 mm: T20, T25, T30, T40, T45, T50, T55
- 30 mm: H4, H5, H6, H7, H8, H10, H12
75 mm: H4, H5, H6, H7, H8, H10, H12
- 30 mm: M5, 6, 8, 10, 12
75 mm: M5, 6, 8, 10, 12



Ref.	☒	EAN
06-107	0/10	5907558414424



S2
steel

CrV
steel

x38

1/4"

1/2"



NEO
TOOLS

25 years
GUARANTEE

S2
steel



3/8"

x2

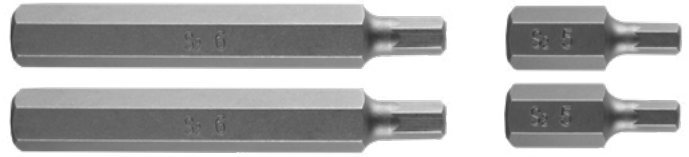

Ref.	Info	L[mm]	☒	EAN
10-970	H5	30	50/200	5907558452884
10-972	H6	30	50/200	5907558452891
10-978	H12	30	50/200	5907558452907
10-980	H5	75	30/120	5907558452914
10-982	H6	75	30/120	5907558452921
10-988	H12	75	30/120	5907558452938

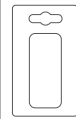

NEO
TOOLS

25 years
GUARANTEE

S2
steel



3/8"

x2

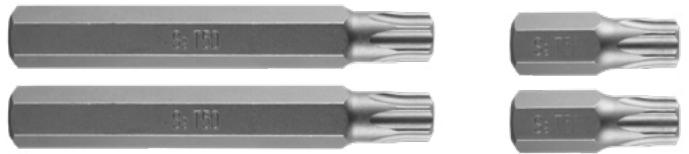

Ref.	Info	L[mm]	☒	EAN
10-920	T30	30	50/200	5907558452785
10-922	T40	30	50/200	5907558452792
10-924	T45	30	50/200	5907558452808
10-926	T50	30	50/200	5907558452815
10-928	T55	30	50/200	5907558452822
10-940	T30	75	30/120	5907558452839
10-942	T40	75	30/120	5907558452846
10-944	T45	75	30/120	5907558452853
10-946	T50	75	30/120	5907558452860
10-948	T55	75	30/120	5907558452877
10-960	T100	75	20/40	5907558452945

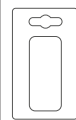

NEO
TOOLS

25 years
GUARANTEE

S2
steel



3/8"

x2

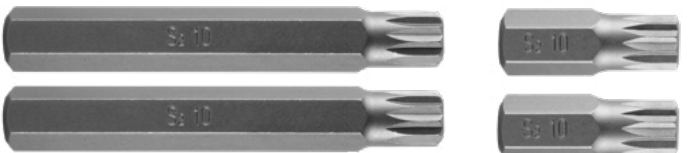

Ref.	Info	L[mm]	☒	EAN
10-900	M8	30	50/200	5907558452723
10-902	M10	30	50/200	5907558452730
10-904	M12	30	50/200	5907558452747
10-906	M8	75	30/120	5907558452754
10-908	M10	75	30/120	5907558452761
10-910	M12	75	30/120	5907558452778

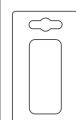

Końcówki wkrętakowe

Driver bits / Einsätze für Schraubendreher / Насадки / Наконечники викрутки / Dugókulcs bitkészlet / Set biti / Šroubovákové nástavce / Skrutkovacie nástavce / Nastavki za izvijače / Atsuktuvo antgaliai / Skrivgrieža uzgaļi / Krivikeerajaotsakud / Накрайници за отвертка / Nastavci za odvijač / Nastavci za odvijač / Καταβιδόμετες / Puntas destornilladoras / Insetti lunghi e corti / Ponteiros Chave de fenda / Embouts de tournevis / Schroevendraaierendstukken

TOPEX

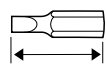

L - 30 mm T20; T25; T30; T40; T45; T50; T55

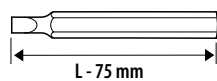

L - 75 mm

T20; T25; T30; T40; T45; T50; T55



Ref. 39D391 EAN 5902062393913

S2

x15

1/2"

TOP TOOLS



3/8" - 10 mm
1/2" - 10 mm



L - 30 mm

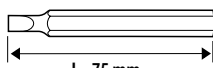

L - 75 mm

T20, T25, T30, T40, T45, T50, T55, H4, H5, H6, H7, H8, H10, H12, M5, M6, M7, M8, M10, M12



Ref. 39D377 EAN 5902062050571

x40
CrV
3/8"
1/2"

Klucze sześciokątne

Hex key set / Sechskantschlüssel / Ключи шестигранные / Ключ шестигранный / Imbuszkulcs készlet / Set chei cu șase laturi / Šestihránný klíč / Súprava imbus klúčov (dlhé) / Garnitura imbus ključev / Šešakampij raktu komplektas / Seškanšu atslēgu komplekts / Kuuskant-mutrivõtmete komplekt / Лумбусы компл. / Ključ imbus set / Ključ imbus set / Συλλογή εξαγωνικών κλειδιών / Llaves Allen / Chiavi esagonali / Chaves hexagonais / Clefs à 6 pans / Zesnantsleutels

NEO TOOLS

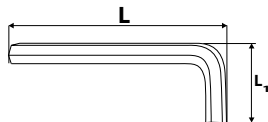

25 years GUARANTEE
CrV steel

NEO TOOLS

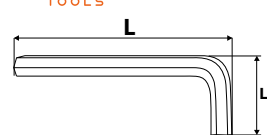

25 years GUARANTEE
TÜVRheinland CERTIFIED
DIN 911
ISO 2936
SUPER HARD
SNCM-V steel
x9

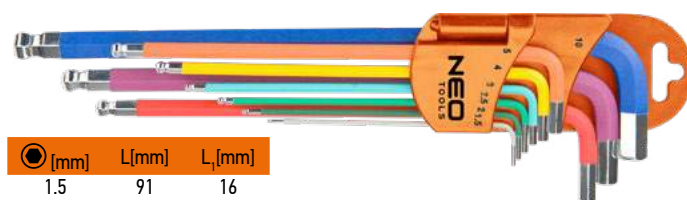

● [mm]	L [mm]	L ₁ [mm]
1.5	91	16
2.0	103	19
2.5	115	20
3.0	130	23
4.0	145	29
5.0	166	35
6.0	188	38
8.0	208	43
10.0	230	50

Ref. 09-512 EAN 5907558403428

NEO TOOLS

25 years GUARANTEE
TÜVRheinland CERTIFIED
S2 steel
x7
DIN 911
ISO 2936



● [mm]	L [mm]	L ₁ [mm]
1.5	63	15
2.0	75	17
2.5	87	20
3.0	90	23
4.0	100	27
5.0	116	32
6.0	137	37

Ref. 09-517 EAN 5907558410273



Ref.	● [mm]	L [mm]	L ₁ [mm]	⊠	EAN
09-530	1.5	77	14	0/1500	5907558414004
09-531	2.0	81	16	0/1500	5907558414011
09-532	2.5	87	18	0/1500	5907558414028
09-533	3.0	94	20	0/1500	5907558414035
09-534	4.0	103	24	0/1000	5907558414042
09-535	4.5	108	26	0/800	5907558414059
09-536	5.0	115	28	0/500	5907558414066
09-537	5.5	122	30	0/500	5907558414073
09-538	6.0	129	32	0/500	5907558414080
09-539	7.0	136	34	0/300	5907558414097
09-540	8.0	147	36	0/200	5907558414103
09-541	9.0	159	38	0/200	5907558414110
09-542	10.0	170	40	0/150	5907558414127
09-543	12.0	190	45	0/80	5907558414134
09-544	13.0	205	48	0/80	5907558414141
09-545	14.0	216	54	0/60	5907558414158
09-546	17.0	245	63	0/40	5907558414165

Klucze sześciokątne

Hex key set / Sechskantschlüssel / Ключи шестигранные / Ключ шестигранный / Imbuskulcs készlet / Set chei cu șase laturi / Šestihránný klíč / Súprava imbus kľúčov (dlhé) / Garnitura imbus kľučev / Šešiacampij raktų komplektas / Seškanšu atslėgu komplekts / Kuuskant-mutrivõtmete komplekt / Лимбуси компл. / Kľučí imbus set / Kľuč imbus set / Συλλογή εξαγωνικών κλειδιών / Llaves Allen / Chiavi esagonali / Chaves hexagonais / Clefs à 6 pans / Zeskantsleutels

NEO
TOOLS

25
years
GUARANTEE



S2
steel

x8

ISO
2936



⌀ [mm]	L [mm]	L _i [mm]
2.0	85	18
2.5	90	20
3.0	97	23
4.0	106	28
5.0	118	30
6.0	138	36
8.0	159	40
10.0	180	46

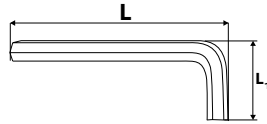

Ref. EAN
09-513 6/36 5907558403411

NEO
TOOLS

25
years
GUARANTEE

CrV
steel

x8

ISO
2936

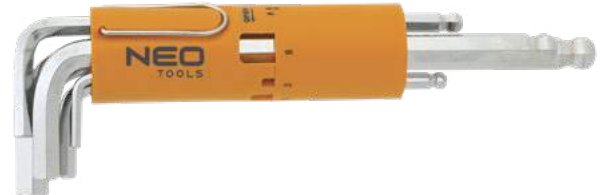

⌀ [mm]	L [mm]	L _i [mm]
2.0	85	18
2.5	90	20
3.0	97	23
4.0	106	28
5.0	118	30
6.0	138	36
8.0	159	40
10.0	180	46

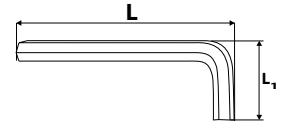

Ref. EAN
09-523 10/40 5907558414288

NEO
TOOLS

25
years
GUARANTEE



S2
steel

x9

DIN
911

ISO
2936



⌀ [mm]	L [mm]	L _i [mm]
1.5	92	15
2.0	100	18
2.5	114	20
3.0	127	22
4.0	143	28
5.0	164	31
6.0	185	37
8.0	205	43
10.0	235	47

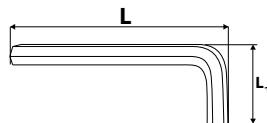
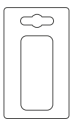

Ref. EAN
09-515 12/48 5907558409314

NEO
TOOLS

25
years
GUARANTEE

CrV
steel

x9

DIN
911

ISO
2936



⌀ [mm]	L [mm]	L _i [mm]
1.5	92	15
2.0	100	18
2.5	114	20
3.0	127	22
4.0	143	28
5.0	164	31
6.0	185	37
8.0	205	43
10.0	235	47

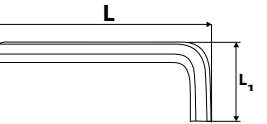
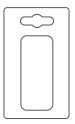

Ref. EAN
09-525 6/24 5907558414301

NEO
TOOLS

1.5 - 2 - 2.5 - 3 - 4 - 5 - 6 - 8 mm

25
years
GUARANTEE

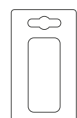

Ref. EAN
09-571 6/24 5907558450460

TOPEX

CrV

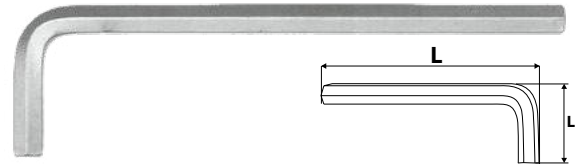

Ref.	W [mm]	L [mm]	L _i [mm]		EAN
35D904	4	109	25	25/100	5902062372048
35D905	5	120	28	150/600	5902062372055
35D906	6	134	32	100/400	5902062372062
35D907	7	142	34	80/320	5902062372079
35D908	8	149	36	45/180	5902062372086
35D910	10	170	40	25/100	5902062372109
35D912	12	195	44	20/80	5902062372123
35D913	13	223	46	15/60	5902062372130
35D914	14	255	49	10/40	5902062372147
35D917	17	290	53	4/24	5902062372178
35D919	19	330	56	3/18	5902062372192

TOPEX

1,5; 2; 2,5; 3; 4; 5; 6; 8; 10 mm

x9

CrV



Ref. EAN
35D966 12/36 5902062005960

TOPEX

1,5; 2; 2,5; 3; 4; 5; 5,5; 6; 8; 10 mm

CrV



x10

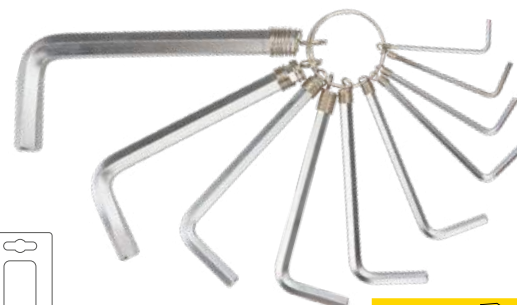

Ref. EAN
35D954 10/60 5902062359544

Klucze sześciokątne

Hex key set / Sechskantschlüssel / Ключи шестигранные / Ключ шестигранный / Imbuskulcs készlet / Set chei cu șase laturi / Šestihránný klíč / Súprava imbus kľúčov (dlhé) / Garnitura imbus kľučev / Šešakampij raktų komplektas / Seškanšu atslēgu komplekts / Kuuskant-mutrivõtmete komplekt / Лимбуси компл. / Kľuč imbus set / Kľuč imbus set / Συλλογή εξαγωνικών κλειδιών / Llaves Allen / Chiavi esagonali / Chaves hexagonais / Clefs à 6 pans / Zeskantsleutels

TOPEX

● 1,5; 2; 2,5; 3; 4; 5; 6; 8; 10 mm



CrV



X9

Ref. 35D955 10/40 EAN 5902062371102

TOPEX

● 1,5; 2; 2,5; 3; 4; 5; 6; 8; 10 mm



CrV



X9

Ref. 35D956 12/36 EAN 5902062371201

TOPEX

● 1,5; 2; 2,5; 3; 4; 5; 6; 8; 10 mm



CrV



X9

Ref. 35D957 12/36 EAN 5902062371300

TOPEX

● 1,5; 2; 2,5; 3; 4; 5; 6; 8; 10 mm



CrV



X9

Ref. 35D962 6/36 EAN 5902062359629

TOPEX

● 1,5; 2; 2,5; 3; 4; 5; 5,5; 6 mm



X8

CrV



Ref. 35D958 10/100 EAN 5902062359582

TOPEX

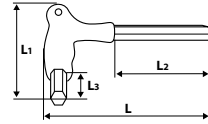

CrV



X8

● (mm)	L (mm)	L1 (mm)	L2 (mm)	L3 (mm)
2	150	65	100	11
2,5	150	65	100	11
3	150	65	100	11
4	150	65	100	11
5	215	90	150	16
6	215	90	150	16
8	280	115	200	20
10	280	115	200	20

Ref. 35D967 0/20 EAN 5902062359674

TOPEX



CrV



X8

● (mm)	L (mm)	L1 (mm)	L2 (mm)	L3 (mm)
2	135	55	100	15
2,5	135	55	100	15
3	135	55	100	15
4	135	55	100	15
5	200	70	150	20
6	200	70	150	20
8	260	85	200	20
10	260	85	200	20

Ref. 35D963 0/10 EAN 5902062359636

TOP TOOLS

● 2, 2,5, 3, 4, 5, 6, 8, 10 mm

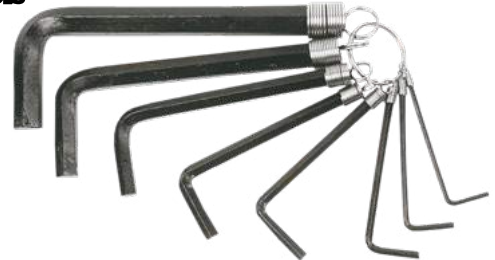

X8

Ref. 35D055 45/90 EAN 5902062040817

TOP TOOLS

● 1,5, 2, 2,5, 3, 4, 5, 6, 8, 10 mm



X9

Ref. 35D051 12/48 EAN 5902062004727

Klucze Torx

Torx key wrench set / Torx-Schlüssel / Κλειδιά Torx / Ключи "Torx" / Torx kulcskészlet / Set chi de tip "torx" / Klíče Torx / Súprava Torx kľúčov / Garnitura ključev torx / Raktai TORX / Torx atslēgu komplekts / "Torx" mutrivõtmete komplekt / Лумбџы компл. / Кључ имбус / Κλειδιά Torx / Llaves torx / Set chiavi Torx / Chaves torx / Clefs Torx / Torxsleutels

NEO
TOOLS

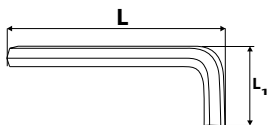

Ref.	⚙️	L[mm]	L ₁ [mm]	📦	EAN
09-550	T10	77	14	0/1500	5907558414172
09-551	T15	84	16	0/1500	5907558414189
09-552	T20	92	18	0/1000	5907558414196
09-553	T25	101	20	0/1000	5907558414202
09-554	T27	111	24	0/500	5907558414219
09-555	T30	122	28	0/500	5907558414226
09-556	T40	136	32	0/400	5907558414233
09-557	T45	152	36	0/300	5907558414240
09-558	T50	176	40	0/200	5907558414257
09-559	T55	183	44	0/100	5907558414264

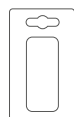

NEO
TOOLS



⚙️	L[mm]	L ₁ [mm]
T10	89	20
T15	105	22
T20	115	23
T25	130	25
T27	146	30
T30	167	35
T40	184	38
T45	204	45
T50	226	50

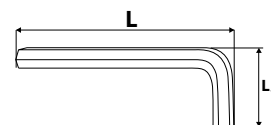

Ref.	📦	EAN
09-518	6/48	5907558420661

NEO
TOOLS



⚙️	L[mm]	L ₁ [mm]
TT10	88	20
TT15	93	22
TT20	98	23
TT25	105	24
TT30	119	30
TT40	130	32
TT45	144	37
TT50	160	40

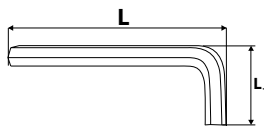

Ref.	📦	EAN
09-514	6/36	5907558403428

NEO
TOOLS



⚙️	L[mm]	L ₁ [mm]
TT10	88	20
TT15	93	22
TT20	98	23
TT25	105	24
TT30	119	30
TT40	130	32
TT45	144	37
TT50	160	40

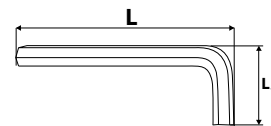

Ref.	📦	EAN
09-524	10/40	5907558414295

NEO
TOOLS

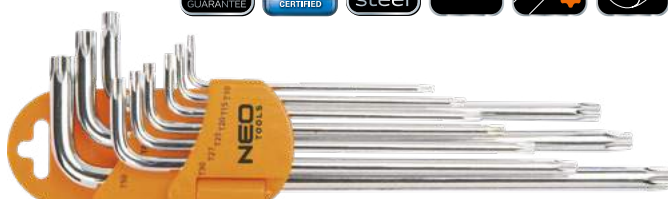

⚙️	L[mm]	L ₁ [mm]
T10	89	20
T15	105	22
T20	115	23
T25	130	25
T27	146	30
T30	167	35
T40	184	38
T45	204	45
T50	226	50

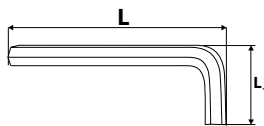

Ref.	📦	EAN
09-516	12/48	5907558409321

NEO
TOOLS



⚙️	L[mm]	L ₁ [mm]
T10	89	20
T15	105	22
T20	115	23
T25	130	25
T27	146	30
T30	167	35
T40	184	38
T45	204	45
T50	226	50

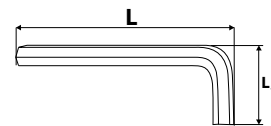

Ref.	📦	EAN
09-526	6/24	5907558414318

NEO
TOOLS

⚙️ T9; T10; T15; T20; T25; T27; T30; T40

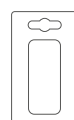

Ref.	📦	EAN
09-573	6/24	5907558450477

TOPEX

⚙️ T10; T15; T20; T25; T27; T30; T40; T45; T50



Ref.	📦	EAN
35D969	12/36	5902062005977

Klucze Torx

Torx key wrench set / Torx-Schlüssel / Ключи Torx / Ключи "Torx" / Torx kulcskészlet / Set chi de tip "torx" / Klíče Torx / Súpava Torx ključov / Garnitura ključev torx / Raktai TORX / Torx atslėgu komplekts / "Torx" mutrivõtmete komplekt / Лумбуси компл. / Ključ imbus / Кλειδιά Torx / Llaves torx / Set chiavi Torx / Chaves torx / Clefs Torx / Torxsleutels

TOPEX

T10, T15, T20, T25, T27, T30, T40, T45, T50

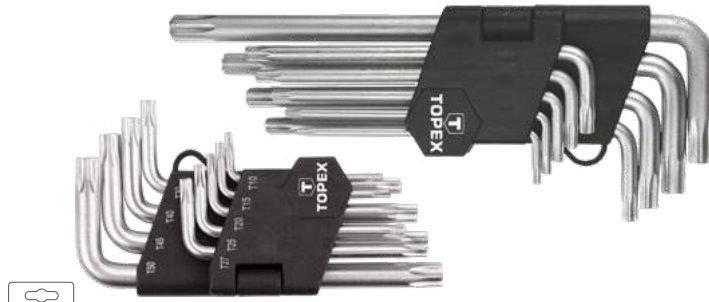

Ref.	📦	EAN
35D961	6/36	5902062359612
35D960	10/40	5902062371409

TOPEX

T9, T10, T15, T20, T25, T27, T30, T40



Ref.	📦	EAN
35D959	10/100	5902062359599

TOPEX



X9

🌀	L [mm]	L1 [mm]	L2 [mm]	L3 [mm]
T10	150	65	100	11
T15	150	65	100	11
T20	150	65	100	11
T25	200	65	150	11
T27	200	65	150	15
T30	210	90	150	15
T40	210	90	150	15
T45	280	115	200	20
T50	280	115	200	20

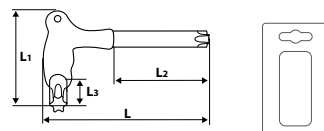

Ref.	📦	EAN
35D968	6/24	5902062359681

TOPEX

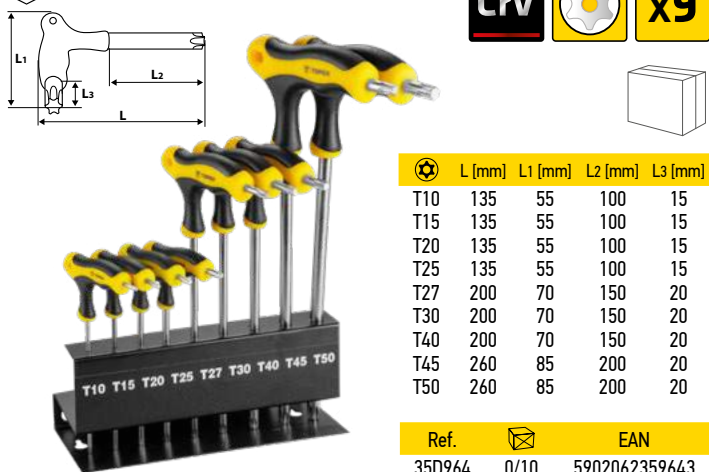

X9

🌀	L [mm]	L1 [mm]	L2 [mm]	L3 [mm]
T10	135	55	100	15
T15	135	55	100	15
T20	135	55	100	15
T25	135	55	100	15
T27	200	70	150	20
T30	200	70	150	20
T40	200	70	150	20
T45	260	85	200	20
T50	260	85	200	20

Ref.	📦	EAN
35D964	0/10	5902062359643

Klucze sześciokątne i Torx

Hexagonal and Torx wrenches / Sechskant- und Torx-Schlüssel / Шестигранные ключи и Torx / Ключи шестигранный и «Torx» / Imbus és Torx kulcs készlet / Chei hexagonale și Torx / Šestihranné a Torx klíče / Šestihranné a torxové klíče / Kľučí inbus in torx / Torciniai raktai / Seššūtra atslėgas un Torx atslėgas / Kuuskant- ja Torx-võtmed / Шестозъелни ключове и торкс / Šesterokutni ključevi i Torx / Imbus i Torx ključ / Εξάγωνα κλειδιά και κλειδιά Torx / Llaves hexagonales y torx / Chiavi esagonali e Torx / Chaves hexagonais e Torx / Clefs à 6 pans et Torx / Zeskant en Torx sleutels

TOPEX

1.5, 2, 2.5, 3, 4, 5, 6, 8, 10 mm

T10, T15, T20, T25, T27, T30, T40, T45, T50

X18



Ref.	📦	EAN
35D952	6/24	5902062359520

Klucze pięciokątne

Pentagonal wrenches / Fünfantschlüssel / Пятигранные ключи / Ключи-зірочки / Torx kulcskészlet / Chei pentagonale / Pětihranné klíče / Päthranné klíče / Kľučí zvezda / Penkiakampiai raktai / Piecšūtra atslėgas / Viiskantvõtmed / Петозъелни ключове / Peterokutni ključevi / Petougaoni ključ / Πεντάγωνα κλειδιά / Llaves pentagonales / Chiavi pentagonali TS / Chaves de cinco ângulos / Clefs à 5 pans / Vijfkant sleutels

NEO TOOLS



🌀	L [mm]	L ₁ [mm]
TS10	92	18
TS15	113	20
TS20	116	23
TS25	130	25
TS27	145	30
TS30	165	35
TS40	186	40
TS45	208	45
TS50	232	50

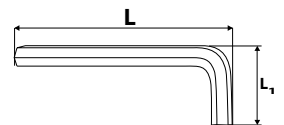

Ref.	📦	EAN
09-520	1/36	5907558410280

TOPEX

T510, TS 15, TS 20, TS 25, TS 27, TS30, TS 40, TS 45, TS 50



X9



Ref.	📦	EAN
35D951	6/36	5902062359513
35D950	6/36	5902062359506

Klucz dynamometryczny

Torque wrench / Drehmomentschlüssel / Ключ динамометрический / Ключ динамометричний / Nyomatékkulcs / Cheie dinamometrică / Dynamometrický klíč / Dynamometrický ključ / Dinamometrični ključ / Dinamometrinis raktas / Dinamometriska atslēga / Dinamoetrične viti / Динамометричен ключ / Dinamometrički ključ / Obrtni ključ / Δυναμομετρικό κλειδί / Llave dinamométrica / Chiave dinamometrica / Chave dinamométrica / Clef dynamométrique / Dynamometrische sleutel

NEO
TOOLS

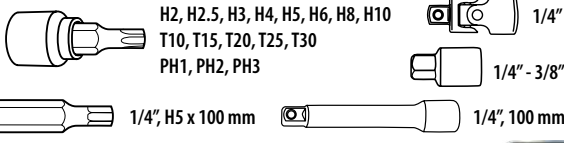

Ref.	Info	EAN
08-821	0/12	5907558458954

NEO
TOOLS



Ref.	Info	EAN
08-835	40-220Nm	5907558458930
08-837	60-330Nm	5907558458947

NEO
TOOLS



Ref.	Info	EAN
08-823	3/8", 10 – 60 Nm	5907558444544
08-824	3/8", 20 – 100 Nm	5907558444551
08-825	1/2", 40 – 200 Nm	5907558444568
08-826	1/2", 60 – 350 Nm	5907558444599

NEO
TOOLS



Ref.	Info	EAN
08-827	1/2", 20 – 210 Nm	5907558444575
08-828	1/2", 60 – 350 Nm	5907558444582

TOPEX

1/2"

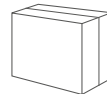

Ref.	Info	EAN
37D109	40-200 Nm	5902062371096

TOP TOOLS

1/2"

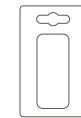

Ref.	Info	EAN
37D105	0-200 Nm	5902062040718

TOP TOOLS

1/2"

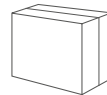

Ref.	Info	EAN
37D110	43-180 Nm	5902062040725

Kątomierz do dokręcania śrub

Torque angle gauge / Winkelmesser zum schraubenanziehen / Угломер для затяжки болтов / Нутомір для догвинчування гвинтів / Szögmérő csavar meghúzáshoz / Raportor la strângerea șuruburilor / Úhloměr k utahování šroubů / Úhlomer krútiaceho momentu / Kotomer za privijanje vijakov / Varžtu užspaidimo kampromatiklis / Leņķmērs skrūvju pievilkšanai / Nurgamōdīk poltide pingutamiseks / Ёгломер за динамометричен ключ / Kutomjer za zatezanje vijaka / Uglomer za zavrtnanje šrafova / Γωνιόμετρο αόφιξης βιδών / Escuadra para atornillar tornillos / Goniometro per avvitare le viti / Transferidor para aparafusar / Clé de serrage angulaire

NEO
TOOLS

1/2"

360°

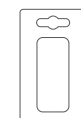

Ref.	EAN
08-830	5907558416770

Klucz płasko-oczkowy

Combination spanner / Maul-Ringschlüssel / Ключ комбинированный / Ключ комбинований, ріжково-накидний / Csillag-villáskulcs / Cheie combinată / Ključ očko-plochy / Ključ OP / Ključ viličasto-obročni / Raktas plokščias - kilpinis / Kombinētā atslēga / Universaalne mutrivõti / Ключ звездогаечен / Ключ комбинирани / Ключ комбиновани / Γερανοαπόλυγωνα / Llave combinada / Chiave combinata / Chave plana-de luneta / Clef à fourche-polygonale / Moersleutel

NEO
TOOLS

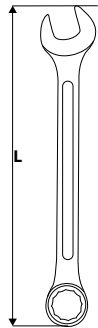

Ref.	● [mm]	L [mm]	☒	EAN
09-706	6	100	0/200	5907558410914
09-707	7	110	5/200	5907558410921
09-708	8	120	5/200	5907558410938
09-709	9	130	5/200	5907558410945
09-710	10	140	5/200	5907558410952
09-711	11	150	5/200	5907558410969
09-712	12	160	5/200	5907558410976
09-713	13	170	5/200	5907558410983
09-714	14	180	5/100	5907558410990
09-715	15	190	5/100	5907558411003
09-716	16	200	5/100	5907558411010
09-717	17	210	5/100	5907558411027
09-718	18	220	5/100	5907558411034
09-719	19	230	5/100	5907558411041
09-720	20	240	5/100	5907558411058
09-721	21	250	5/100	5907558411065
09-722	22	260	5/50	5907558411072
09-723	23	260	5/30	5907558411089
09-724	24	280	5/50	5907558411096
09-725	25	295	5/40	5907558411102
09-727	27	310	5/50	5907558411126
09-728	28	310	5/40	5907558411133
09-729	29	340	4/40	5907558411140
09-730	30	340	4/30	5907558411157
09-732	32	360	4/40	5907558411164
09-734	34	380	4/20	5907558411171
09-736	36	410	5/10	5907558412611
09-738	38	430	5/20	5907558412628
09-741	41	460	2/10	5907558412635
09-746	46	500	5/10	5907558412642
09-747	50	540	5/10	5907558412659
09-748	55	560	0/4	5907558412666
09-749	60	600	0/2	5907558412673

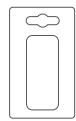

NEO
TOOLS

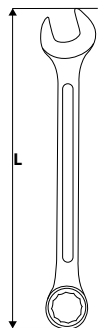

Ref.	● [mm]	L [mm]	☒	EAN
09-406	6	100	25/400	5907558422375
09-407	7	110	25/400	5907558422382
09-408	8	120	25/400	5907558422399
09-409	9	130	25/400	5907558422405
09-410	10	140	25/400	5907558422412
09-411	11	150	25/300	5907558422429
09-412	12	160	25/300	5907558422436
09-413	13	170	25/300	5907558422443
09-414	14	180	25/200	5907558422450
09-415	15	190	25/200	5907558422467
09-416	16	200	25/150	5907558422474
09-417	17	210	25/150	5907558422481
09-418	18	220	10/120	5907558422498
09-419	19	230	10/120	5907558422504
09-420	20	240	10/100	5907558422511
09-421	21	250	10/100	5907558422528
09-422	22	260	10/100	5907558422535
09-423	23	260	10/80	5907558422542
09-424	24	280	10/80	5907558422559
09-425	25	295	10/60	5907558422566
09-426	26	295	10/60	5907558422573
09-427	27	310	10/40	5907558422580
09-428	28	310	10/40	5907558422597
09-429	29	340	10/40	5907558422603
09-430	30	340	10/40	5907558422610
09-432	32	360	10/40	5907558422627

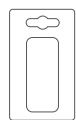

NEO
TOOLS

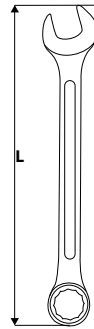

Ref.	● [mm]	L [mm]	☒	EAN
09-760	8	90	10/200	5907558410198
09-761	9	93	5/200	5907558410204
09-762	10	96	5/200	5907558410211
09-763	11	98	10/200	5907558410228
09-764	12	102	10/200	5907558410235
09-765	13	109	5/200	5907558410242
09-766	14	113	10/200	5907558410259
09-767	15	118	10/120	5907558410266
09-768	16	123	10/120	5907558412765
09-769	17	129	10/200	5907558412772
09-770	18	131	10/120	5907558412789
09-771	19	134	10/150	5907558412796

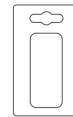

NEO
TOOLS

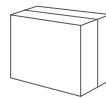

Ref.	● [mm]	☒	EAN
09-791	8, 9, 10, 12, 13, 14, 17, 19 mm	0/20	5907558413090

NEO
TOOLS

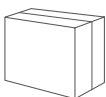

Ref.	● [mm]	N	☒	EAN
09-750	6, 8, 10, 13, 15, 17	x6	0/25	5907558411515
09-751	6, 8, 10, 12, 13, 14, 17, 19	x8	0/25	5907558411522
09-752	6, 7, 8, 10, 11, 12, 13, 14, 15, 17, 19, 22	x12	0/20	5907558411539
09-753	8, 9, 10, 11, 12, 13, 14, 15, 16, 17, 18, 19, 22, 24, 27, 30, 32	x17	0/6	5907558413106
09-754	6, 7, 8, 9, 10, 11, 12, 13, 14, 15, 16, 17, 18, 19, 20, 21, 22, 23, 24, 25, 26, 27, 28, 29, 30, 32	x26	0/4	5907558413113

Klucz płasko-oczkowy

Combination spanner / Maul-Ringschlüssel / Ключ комбинированный / Ключ комбінований, ріжково-накладний / Csillag-villáskulcs / Cheie combinată / Ključ očko-pločny / Ključ OP / Ključ viličasto-obročni / Raktas plokščias - kilpinis / Kombinētā atslēga / Universaalne mutrivõti / Ключ звездогаечен / Ключ комбинирани / Ключ комбиновани / Γεραμαναπόλυγωνα / Llave combinada / Chiave combinata / Chave plana-de luneta / Clef à fourche-polygonale / Moersleutel

TOPEX

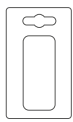
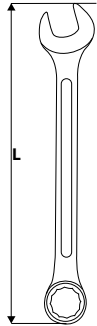

Ref.	● [mm]	L [mm]	☒	EAN
35D380	6	100	25/400	5902062004789
35D381	7	100	25/400	5902062004796
35D382	8	110	25/300	5902062004802
35D383	10	125	25/300	5902062004819
35D384	12	140	25/200	5902062004826
35D385	13	145	25/200	5902062004833
35D386	14	160	25/200	5902062004840
35D387	15	175	25/200	5902062004857
35D388	16	185	20/160	5902062004864
35D389	17	205	20/120	5902062004871
35D390	18	205	20/120	5902062004888
35D391	19	230	20/120	5902062004895
35D392	22	260	20/80	5902062004901
35D393	24	280	20/60	5902062004918
35D394	27	310	10/40	5902062004925
35D395	30	360	10/30	5902062004932
35D396	32	380	10/30	5902062004949

TOPEX

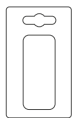
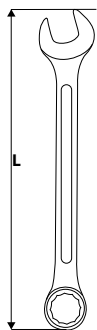

Ref.	● [mm]	L [mm]	☒	EAN
35D701	6	100	20/400	5902062044457
35D702	7	110	20/400	5902062044464
35D703	8	120	20/400	5902062044471
35D705	10	140	20/320	5902062044488
35D707	12	160	20/200	5902062044495
35D708	13	170	20/200	5902062044501
35D709	14	180	20/200	5902062044518
35D710	15	190	20/200	5902062044525
35D711	16	200	20/160	5902062044532
35D712	17	210	20/160	5902062044549
35D713	18	220	20/120	5902062044556
35D714	19	230	20/120	5902062044563
35D716	22	260	10/90	5902062044570
35D718	24	280	10/60	5902062044587
35D721	27	310	10/40	5902062044594
35D723	30	340	10/40	5902062044600
35D725	32	350	10/30	5902062044617

TOPEX

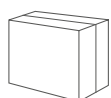

TOPEX



Ref.	● [mm]	N	☒	EAN
35D374	6; 8; 10; 12; 13; 15; 17; 19 mm	x8	5/30	5902062005168
35D375	6; 7; 8; 9; 10; 11; 12; 13; 15; 17; 19; 22 mm	x12	5/20	5902062005175

TOPEX



Ref.	● [mm]	N	☒	EAN
35D397	8; 10; 12; 13; 15; 17	x6	5/40	5902062004956

TOPEX



Ref.	● [mm]	N	☒	EAN
35D755	8, 10, 12, 13, 14, 17	x6	4/40	5902062044624
35D756	6, 8, 10, 12, 13, 14, 17, 19	x8	4/32	5902062044631
35D757	6, 7, 8, 9, 10, 11, 12, 13, 14, 17, 19, 22	x12	2/20	5902062044648

Ref.	● [mm]	☒	EAN
35D758	13, 14, 15, 16, 17, 18, 19, 22, 24, 27, 30, 32	0/6	5902062357588

Klucz płasko-oczkowy

Combination spanner / Maul-Ringschlüssel / Ключ комбинированный / Ключ комбинований, ріжково-накидний / Csillag-villáskulcs / Cheie combinată / Кліч очко-пlochý / Кліч ОР / Кіjuč viličasto-obročni / Raktas plokščias - kilpinis / Kombinētā atslēga / Universaalne mutrivõti / Ключ звездозачечен / Кіjuč kombinirani / Кіjuč kombinovani / Γερμανοπoλύγωνο / Llave combinada / Chiave combinata / Chave plana-de luneta / Clef à fourche-polygonale / Moersleutel

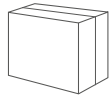

Ref.	● [mm]	N	☒	EAN
35D355	8-17	×6	15/60	5902062040428
35D356	6-19	×8	10/40	5902062040442
35D357	6-22	×12	5/20	5902062201850
35D359	6-22	×12	0/20	5902062353597
35D360	6-19	×8	0/30	5902062353603
35D370	6-32	×25	0/4	5902062040466

Klucz płasko-oczkowy z grzechotką

Combination spanner with ratchet / Ringschlüssel mit Ratsche / Ключ комбинированный с трещоткой / Ключ ріжково-накидний з трісчаткою / Csillag-villáskulcs racsnis / Cheie fixă -inelară cu clichet / Očkoplochý klíč ráčnový / Plochý-očkový klíč s račťou / Ploščato-obročni ključ z ragljo / Raktas plokščias, kilpinis su terkšle / Kombinētā atslēga / Kōristiga leht-silmusvõti / Комбинирана трещотка / Plosnato-okasti ključ s nastavkom / Pljosnato-okasti ključ sa čegrtaljkom / Κλειδί γερμανοπoλύγωνο με καστίνα / Llaves combinadas (de estrella y a carraca abierta) con carraca / Chiave combinata a cricchetto / Chave plana-de luneta z catraca de furar / Clef à fourche-polygonale à cliquet / Moersleutel met ratel

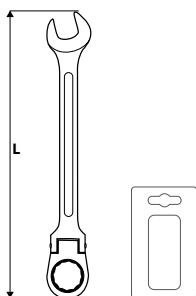

Ref.	● [mm]	L [mm]	☒	EAN
09-051	8	140	10/200	5907558403435
09-052	10	162	10/160	5907558403442
09-055	13	181	10/120	5907558403459
09-057	15	202	10/100	5907558403466
09-059	17	237	10/80	5907558403473
09-061	19	250	10/60	5907558403480
09-062	21	255	10/50	5907558424140
09-053	22	255	5/50	5907558424096
09-054	24	274	5/50	5907558424102
09-056	27	312	5/30	5907558424119
09-058	30	350	6/24	5907558424126
09-060	32	390	8/16	5907558424133

Klucz płasko-oczkowy z grzechotką

Combination spanner with ratchet / Ringschlüssel mit Ratsche / Ключ комбинированный с трещоткой / Ключ ріжково-накидний з трісчаткою / Csillag-villáskulcs racsnis / Cheie fixă -inelară cu clichet / Očkoplochý klíč ráčnový / Plochý-očkový klíč s račťou / Ploščato-obročni ključ z ragljo / Raktas plokščias, kilpinis su terkšle / Kombinētā atslēga / Kōristiga leht-silmusvõti / Комбинирана трещотка / Plosnato-okasti ključ s nastavkom / Pljosnato-okasti ključ sa čegrtaljkom / Κλειδί γερμανοπoλύγωνο με καστίνα / Llaves combinadas (de estrella y a carraca abierta) con carraca / Chiave combinata a cricchetto / Chave plana-de luneta z catraca de furar / Clef à fourche-polygonale à cliquet / Moersleutel met ratel

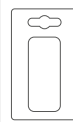
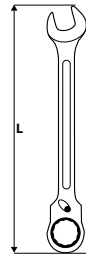

Ref.	● [mm]	L [mm]	☒	EAN
09-320	8 mm	20	10/100	5907558444919
09-321	9 mm	21	10/100	5907558444926
09-322	10 mm	22	10/100	5907558444933
09-323	11 mm	22	10/100	5907558444940
09-324	12 mm	23	10/100	5907558444957
09-325	13 mm	26	5/100	5907558444964
09-326	14 mm	27	5/100	5907558444971
09-327	15 mm	27	5/50	5907558444988
09-328	16 mm	28	5/50	5907558444995
09-329	17 mm	30	5/50	5907558445008
09-330	18 mm	31	5/50	5907558445015
09-331	19 mm	32	5/50	5907558445022
09-333	21 mm	38	5/50	5907558445046
09-334	22 mm	38	5/50	5907558445053
09-336	24 mm	42	5/25	5907558445077
09-338	26 mm	45	5/25	5907558445091
09-339	27 mm	45	5/25	5907558445107
09-340	28 mm	49	5/25	5907558445114
09-341	30 mm	49	5/20	5907558445121
09-342	32 mm	52	5/20	5907558445138

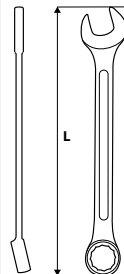

Ref.	● [mm]	L [mm]	☒	EAN
09-063	8	140	10/200	5907558424157
09-064	10	160	10/200	5907558416954
09-065	13	180	10/50	5907558416961
09-066	15	190	10/100	5907558416978
09-067	17	213	0/100	5907558416985
09-068	19	235	10/60	5907558416992
09-069	21	237	10/50	5907558424164
09-042	22	252	5/50	5907558424041
09-043	24	274	5/50	5907558424058
09-044	27	332	6/30	5907558424065
09-045	30	349	6/24	5907558424072
09-046	32	390	8/16	5907558424089

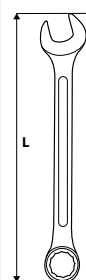

Ref.	● [mm]	L [mm]	☒	EAN
35D740	8	135	10/200	5902062357403
35D741	10	160	10/200	5902062357410
35D747	12	165	10/100	5902062357472
35D743	13	180	10/100	5902062357434
35D744	15	200	10/100	5902062357441
35D745	17	225	10/60	5902062357458
35D746	19	245	10/100	5902062357465
35D748	21	260	5/60	5902062023100
35D749	22	280	6/60	5902062023117
35D750	24	300	10/40	5902062023124

Klucze płaskie dwustronne

Flat double sided wrenches / Mutterschlüssel, beidseitig / Ключи с открытым зевом двухсторонние / Ключи різкової двобічної / Villáskulcs készlet / Cheie fixa / Klíče ploché oboustranné / Klíče ploché obojstranné / Ploščati obojestranski ključji / Pločkšti raktai, dvipusiai / Divpusēja plakana atslēga / Kahepoolsed lehtvõtmed / Пlosки двусторонни ключове / Dvostrani plosnati ključevi / Dvočeljusni pljosnati ključevi / Γερμανικό κλειδί δίπλο / Llaves fijas dobles / Chiavi a forchetta doppia / Chaves planas de duas pontas / Clefs à fourches doubles / Vlakke tweezijdige sleutels

NEO
TOOLS



Ref.	● [mm]	L [mm]	☒	EAN
09-806	6x7	120	10/600	5907558411195
09-808	8x9	140	10/200	5907558411201
09-810	10x11	160	10/300	5907558411218
09-812	12x13	170	10/200	5907558411225
09-814	14x15	190	10/100	5907558411232
09-816	16x17	200	10/100	5907558411249
09-817	17x19	220	10/100	5907558411454
09-818	18x19	220	5/100	5907558411256
09-819	19x22	234	10/100	5907558411461
09-820	20x22	230	5/100	5907558411263
09-821	21x23	250	5/100	5907558411270
09-824	24x27	270	5/50	5907558411287
09-825	25x28	285	5/50	5907558411294
09-830	30x32	300	5/50	5907558411300

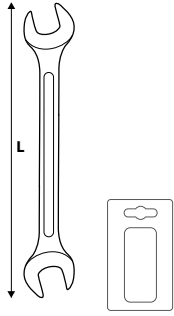

NEO
TOOLS

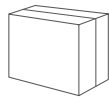

Ref.	● [mm]	☒	EAN
09-860	5,5x7, 8x9, 10x12, 11x13, 14x17, 19x21, 22x23, 24x27	0/20	5907558458916

TOPEX



Ref.	● [mm]	L [mm]	☒	EAN
35D605	10x11	155	20/240	5902062044211
35D607	12x13	170	20/200	5902062044228
35D609	14x15	190	20/200	5902062044235
35D611	16x17	200	0/160	5902062044242
35D613	18x19	220	20/80	5902062044259
35D615	20x22	230	10/100	5902062044266
35D619	24x27	260	10/40	5902062044280
35D623	30x32	300	10/40	5902062044303

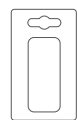

Klucze płaskie dwustronne

Flat double sided wrenches / Mutterschlüssel, beidseitig / Ключи с открытым зевом двухсторонние / Ключи різкової двобічної / Villáskulcs készlet / Cheie fixa / Klíče ploché oboustranné / Klíče ploché obojstranné / Ploščati obojestranski ključji / Pločkšti raktai, dvipusiai / Divpusēja plakana atslēga / Kahepoolsed lehtvõtmed / Пlosки двусторонни ключове / Dvostrani plosnati ključevi / Dvočeljusni pljosnati ključevi / Γερμανικό κλειδί δίπλο / Llaves fijas dobles / Chiavi a forchetta doppia / Chaves planas de duas pontas / Clefs à fourches doubles / Vlakke tweezijdige sleutels

NEO
TOOLS

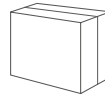

Ref.	● [mm]	N	☒	EAN
09-851	6x7, 8x9, 10x11, 12x13, 14x15, 16x17, 18x19, 20x22	8	0/20	5907558411546
09-852	6x7, 8x9, 10x11, 12x13, 14x15, 16x17, 18x19, 20x22, 21x23, 24x27, 25x28, 30x32	12	0/8	5907558413120

TOPEX



Ref.	● [mm]	N	☒	EAN
35D655	6x7, 8x9, 10x11, 12x13, 14x15, 16x17	x6	4/40	5902062044655
35D656	6x7, 8x9, 10x11, 12x13, 14x15, 16x17, 18x19, 20x22	x8	4/24	5902062044662
35D657	6x7, 8x9, 10x11, 12x13, 14x15, 16x17, 18x19, 20x22, 21x23, 24x27, 25x28, 30x32	x12	2/10	5902062044679

Klucze płaskie dwustronne

Flat double sided wrenches / Mutterschlüssel, beidseitig / Ключи с открытым зевом двухсторонние / Ключи різьбові двобічні / Villáskulcs készlet / Cheie fixa / Klíče ploché obojstranné / Klíče ploché obojstranné / Ploščati obojestranski ključji / Ploščiti raktai, dvipusiai / Divpusēja plakana atslēga / Kahepoolsed lehtvõtmed / Плоски двосторонни ключове / Dvostrani plosnati ključevi / Dvočeljusni pljosnati ključevi / Γερμανικό κλειδί δίπλο / Llaves fijas dobles / Chiavi a forchetta doppia / Chaves planas de duas pontas / Clefs à fourches doubles / Vlakke tweezijdige sleutels



Ref.	● [mm]	N	📦	EAN
35D255	6-17	×6	20/80	5902062040244
35D256	6-22	×8	10/40	5902062040268
35D257	6-32	×12	5/15	5902062043214

Klucze oczkowe wygięte

Offset ring spanner / Ringschlüssel, gebogen / Ключ накидной изогнутый / Ключ накидный, выгнутый / Csillagkulcs készlet / Cheie inelară semiluna / Očkový klíč zahnutý / Očkový klíč vyhnutý / Obročni ukrivljeni ključ / Kilpinis raktas, lenktas / Izliekta uzmanas atslēga / Poolkuu-silmusvõti / Глук заечен ключ отъгнат / Okasti savinut ključ / Okasti izvijeni ključ / Кλειδί πολύγωνο κυρτό / Llave de estrella de media luna / Chiavi doppie poligonale a mezza luna / Chaves de luneta curvadas / Clefs polygonaux coudées / Uitgebogen ringsleutels

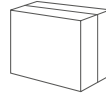

Ref.	● [mm]	📦	EAN
09-176	9x12, 13x15, 14x17, 16x18, 19x22	0/10	5907558404876

Klucz płaski jednostronny

Open single end spanner / Maulschlüssel einseitig / Ключ разжимной односторонний / Ключ різьбовий / Villáskulcs / Cheie piuliță unilaterală cu cavitatea deschisă / Plochý klíč jednostranný / Klíč vidlicový jednostranný / Viličasti ključ / Plošččias vienpusis raktas / Ragatslēga / Ūhe avatud otsaga vōti / Ключ гаечен / Ključ vijuščasti / Ključ vijuskasti / Μονό γερμανικό κλειδί / Llave fija de una boca / Chiave a forchetta / Chave plana / Clef à fourche simple / Eenzijdig vlakke sleutel

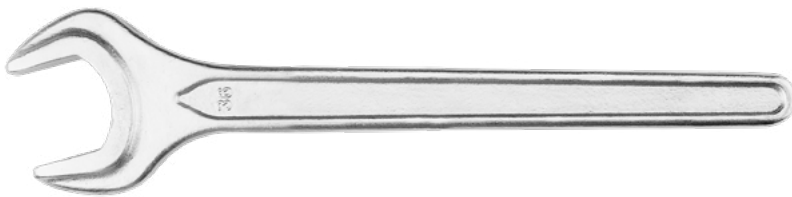

Ref.	● [mm]	L [mm]	📦	EAN
35D630	36	300	5/40	5902062356307
35D632	41	300	4/40	5902062356321
35D633	46	370	5/20	5902062356338
35D635	55	440	4/16	5902062356352
35D636	60	480	4/12	5902062356369



Klucz oczkowy półotwarty

Flare nut wrench / Ringschlüssel halboffen / Ключ разрезной двусторонний / Ключ торцевой нарезной двосторонний / Fékssókulcs / Cheie piuliță în formă de con / Očkový klíč polootevřený / Klíč otvorený očkový / Obročni ključ, odprti / Kilpinis raktas / Bremžu trubiņu atslēga / Vargamutri vōti / Ключ гаечен / Ključ ekscentrični / Ključ / Πολύγωνο κλειδί ημίανοιχτο / Llave de estrella, abierta / Chiave doppia ad anello aperto / Chave de luneta semi aberta / Clef polygonale demi ouverte / Halboffen ringsleutel

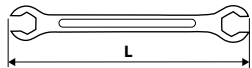

Ref.	● [mm]	L [mm]	📦	EAN
09-141	8x9	130	25/100	5907558404746
09-143	9x11	150	10/200	5907558404753
09-145	10x12	150	10/200	5907558404760
09-147	12x13	170	25/200	5907558404777
09-149	13x14	170	25/100	5907558404784
09-151	15x17	195	25/100	5907558404791

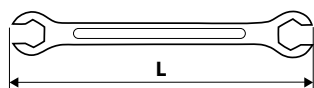
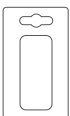

Ref.	● [mm]	L [mm]	📦	EAN
35D596	8x10	135	50/300	5902062355966
35D597	11x13	170	20/200	5902062355973

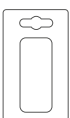

Klucz oczkowy

Ring spanner / Ringschlüssel / Ключ накидной / Ключ накидный / Csillagkulcs / Cheie inelară / Očkový klíč / Očkový klíč / Obročni ključ / Kilpinis raktas / Uzmaucata atslēga / Silmusvõti / Глук гаечен ключ / Okasti ključ / Okasti ključ / Πολύγωνο κλειδί / Llave de estrella / / Chave de luneta / Clef polygonale / Ringsleutel

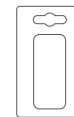

Ref.	● [mm]	📦	EAN
03-030	5 - 16	5/40	5907558445268
03-031	5 - 27	5/20	5907558445275



Ref.	● [mm]	L [mm]	📦	EAN
09-360	8 mm	235	10/100	5907558445145
09-361	10 mm	289	10/100	5907558445152
09-362	12 mm	325	10/100	5907558445169
09-363	13 mm	360	5/50	5907558445176
09-364	14 mm	363	5/50	5907558445183
09-365	16 mm	390	5/50	5907558445190
09-366	17 mm	403	5/50	5907558445206
09-367	19 mm	425	5/50	5907558445213
09-368	22 mm	450	5/25	5907558445220

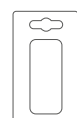

Klucz oczkowy odgięty

Offset ring spanner / Ringschlüssel, gebogen / Ключ накладной изогнутый / Ключ накладный, вигнутий / Csillagkulcs enyhén hajlított / Cheie inelară-cotita / Klíč očkový vyhnutý / Očkový klíč ohnutý / Obročni upogrnjeni ključ / Kīpinis raktas, lenktas / Izliekta uzmanas atslēga / Kōvera otsaga silmusvõti / Глук заечен ключ отъгнат / Fleksibilni okasti ključ / Okasti ključ obrnuti / Κλειδί πολύγωνο κυρτό / Llave de estrella acodada / Chiave poligonale doppia / Chave de luneta curvado / Clef polygonale contre-coudée / Gebogen ringsleutel

NEO
TOOLS

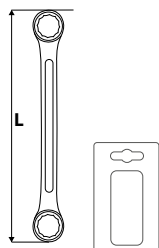

Ref.	● [mm]	L [mm]	☒	EAN
09-906	6x7	170	5/100	5907558411317
09-908	8x9	180	5/100	5907558411324
09-910	10x11	200	5/100	5907558411331
09-912	12x13	210	5/100	5907558411348
09-914	14x15	230	5/60	5907558411355
09-916	16x17	245	5/100	5907558411362
09-918	18x19	265	5/50	5907558411379
09-920	20x22	290	5/40	5907558411386
09-921	21x23	310	4/40	5907558411393
09-924	24x27	330	4/40	5907558411409
09-930	30x32	370	4/40	5907558411430

NEO
TOOLS



25
years
GUARANTEE

TÜV Rheinland
CERTIFIED

CrV
steel

x12

DIN
838

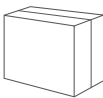

Ref.	● [mm]	☒	EAN
09-952	6x7, 8x9, 10x11, 12x13, 14x15, 16x17, 18x19, 20x22, 21x23, 24x27, 25x28, 30x32	0/6	5907558413137

TOPEX

CrV

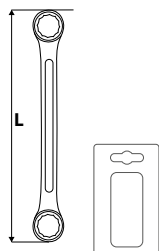

Ref.	● [mm]	L [mm]	☒	EAN
35D807	10x11	205	20/160	5902062044365
35D809	12x13	220	20/120	5902062044372
35D811	14x15	230	10/100	5902062044389
35D813	16x17	250	10/80	5902062044396
35D815	18x19	270	10/60	5902062044402
35D817	20x22	300	10/60	5902062044419
35D821	24x27	340	5/40	5902062044433
35D823	30x32	380	5/30	5902062044440

TOPEX

CrV



Ref.	● [mm]	N	☒	EAN
35D855	6x7, 8x9, 10x11, 12x13, 14x15, 16x17	x6	6/24	5902062044310
35D856	6x7, 8x9, 10x11, 12x13, 14x15, 16x17, 18x19, 20x22	x8	2/16	5902062044327

TOP TOOLS



Ref.	● [mm]	N	☒	EAN
35D455	6-17	x6	12/36	5902062040374

Klucze oczkowe Torx

Offset ring spanner set / Ringschlüssel / Ключи накладные коленчатые / Ключи накладні / Csillagkulcs készlet torx / Set chei inelare de deviatie / Klíče očkové / Súprava očkových klíčov / Obročni ključ / Kīpiniai raktai / Kombinēto izliekta atslēgu komplekts / Mutrivõtmete komplekt / Ключ Лула компл. / Ključ okasti / Πολύγωνα Κλειδιά / Llaves de estrella / Chiavi combinate Torx / Chaves de luneta / Clefs polygonales / Ringsleutels

NEO
TOOLS

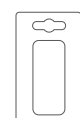

Ref.	★ [mm]	☒	EAN
09-980	T6xT8, T10xT12, T14xT18, T20xT24	20/60	5907558412239

Klucz trzpieniowy nasadowy

T-socket wrench / Vierkant-Aufsteckschlüssel / Ключ торцевой Т-образный / Ключ шестигранный торцевой накидной / T-kulcs / Cheie fixare forma T / Nástrčkový kľúč typu T / T kľúč / T kľuč, nasadni / T formos raktas / T-veida gala atslēga / T-padruni mutrivõti / T-образен ключ / T Kľuč / T kľuc / Καταβτάκι καρύδακι τύπου T / Llave de vaso con mango en T / Chiave a T / Chave tubular / Clef mâle à douilles articulée / Imbusdopsleutel

NEO
TOOLS

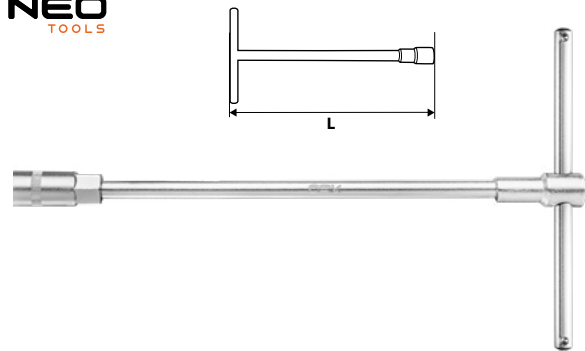

Ref.	● [mm]	L [mm]	☒	EAN
09-302	13	300	25/50	5907558414363

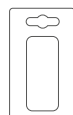

TOPEX

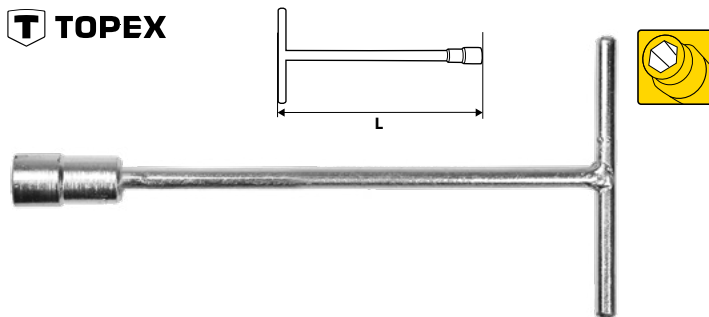

Ref.	● [mm]	L [mm]	☒	EAN
35D030	8	200	0/100	5902062201867
35D031	10	200	50/100	5902062201874
35D032	13	200	50/100	5902062201881
35D035	10	400	0/50	5902062201904
35D036	13	400	0/50	5902062201911

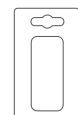

Klucz fajkowy

L-type wrench / Pfeifenschlüssel / Рожковый ключ / Ключ торцовый кривой / Pipakulcs / Cheie tubulară cotită / Zahnfuß kľúč / Fajkový kľúč / Urogrijen kľuč / Pypkinis raktas / Radziņatslēga / Padrunvõti / Ключ лупа / Imbus kľuč / Kosočeljusni zavrtljani kľuč / Γερμανικό κλειδί / Llave de pipa / Chiave a pipa / Chave de cabo curvo / Clef à pipe / Pijpsleutel

NEO
TOOLS

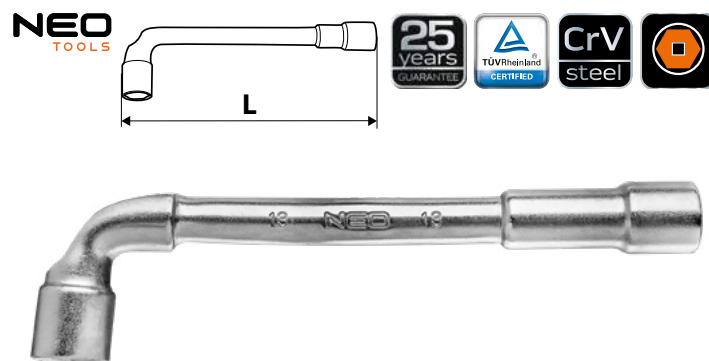

Ref.	● [mm]	L [mm]	☒	EAN
09-203	8	110	10/200	5907558405002
09-205	10	130	10/120	5907558405019
09-207	12	140	10/100	5907558405026
09-208	13	150	10/100	5907558405033
09-210	15	170	10/80	5907558405057
09-212	17	180	10/60	5907558405064
09-214	19	200	10/40	5907558405071

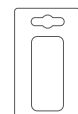

TOPEX

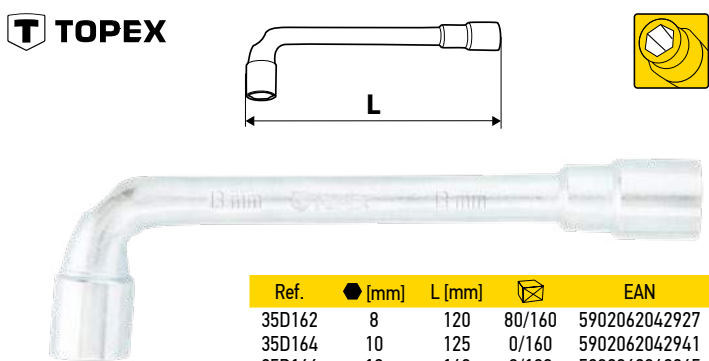

Ref.	● [mm]	L [mm]	☒	EAN
35D162	8	120	80/160	5902062042927
35D164	10	125	0/160	5902062042941
35D166	12	140	0/100	5902062042965
35D167	13	150	0/96	5902062042972
35D168	14	155	0/70	5902062042989
35D169	15	160	0/60	5902062042996
35D171	17	180	0/50	5902062043016
35D173	19	205	0/30	5902062043030
35D176	22	220	0/24	5902062043108
35D177	24	290	0/24	5902062043122
35D179	27	300	4/18	5902062043153
35D180	30	325	0/10	5902062043160
35D181	32	325	4/8	5902062043177

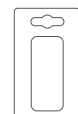

Klucze rurowe

Tube spanners / Rohrschlüssel / Ключи торцовые трубчатые / Ключи трубни / Csőkulcs készlet / Chei tubulare / Trubkové kľúče / Růrkové kľúče / Kľučci za cevi / Raktas vamzdžiams / Cauruļu atslēgas / Toruvõtmed / Тръбни ключове / Kľuččevci za cijevi / Kľuččevci za cevi / Σωληνωτά κλειδιά / Llaves de tubo / Chiavie a tubo / Chaves para Tubos / Clefs à tubes / Buissleutels

TOPEX



TOP TOOLS



Ref.	● [mm]	L [mm]	☒	EAN
35D930	6x7	115	0/100	5902062359308
35D931	8x9	120	0/100	5902062359315
35D932	10x11	125	0/90	5902062359322
35D933	12x13	130	0/100	5902062359339
35D934	14x15	135	0/100	5902062359346
35D935	16x17	150	0/100	5902062359353
35D936	18x19	160	0/75	5902062359360
35D937	20x22	170	10/120	5902062359377
35D938	21x23	170	0/100	5902062359384
35D939	24x26	185	0/54	5902062359391
35D940	25x28	190	0/54	5902062359407
35D941	30x32	200	0/54	5902062359414

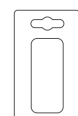
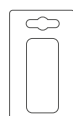

Ref.	● [mm]	N	☒	EAN
35D191	8-17	×6	0/60	5902062042163
35D193	6-22	×10	0/40	5902062040589

Klucz płasko-nasadowy przegubowy

Open end and flex socket wrench / Gelenk-Steckschlüssel / Ключ шарнирный комбинированный / Ключ комбинированный, рижково-торцевий, шарнирний / Villáskulcs flex / Cheie fixă –tubulară cu articulație / Plochý a nástrčný kľúč kloubový / Plochý-nástrčný kľúč kľbový / Ploščato-nasadni ključ z zglobov / Raktas su lankščia galvute antgaliams / Kombinēta šarnīra atslēga / Liigendiga lehtpadrunvõti / Комбиниран шарнирен ключ / Polosnato nastavni zglobovni ključ / Plosonati zglobovni ključevi / Кλειδί γεμματοπολύγωνο αρθρωτό / Llave combinada (fija y de vaso) articulada / Chiave flessibile combinata a forchetta e a bussola / Chave plana articulada / Clef à fourche à douilles articulée / Geopend vlakke dopsleutel

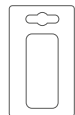

Ref.	● [mm]	☒	EAN
35D240	10	40/160	5902062042101
35D242	13	40/160	5902062041852
35D246	17	35/70	5902062043436
35D247	19	25/50	5902062043443

Klucze hakowe

Power grip pipe wrenches / Hackenschlüssel / Крюковые ключи / Ключи-закли / Univerzální kulcs / Cheie seceră / Hákové kľúče / Hákové kľúče / Ключи с каньем / Lenkti raktai / āku atslēgas / Haakvõtmed / Ключовое с крюка / Kukasti ključevi / Kukasti ključ / Γαγκλιόκλειδα / Llaves de gancho / Giratubi / Chaves de anzol / Clefs à crochets / Haaksleutels

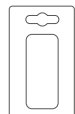

Ref.	● [mm]	☒	EAN
35D251	8-19	10/20	5902062043337

Klucz do rusztowań

Double socket ratchet wrench / Der Schlüssel für das Gerüst / La clé pour échafaudages / Ключ для строительных лесов / Ключ для будівельних лісів / Cheia pentru schele / Chiave per impalcature / Kľúč pro lešení / Kľúč pre lešenie / Raktas

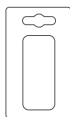

Ref.	Info	☒	EAN
38D300	19x22 mm	10/40	5902062035622

Klucz łańcuchowy do rur

Chain pipe wrench / Kettenschlüssel für Rohre / Ключ трубный цепной / Ключ трубный ланцюговий / Csőfogó láncos / Cheie pentru filtrul cu lant / Řetězový hasák na trubky / Kľúč reťazový na rúry / Verižni ključ za cevi / Grandininis raktas, vamzdžiams / Кēdes cauruļu atslēga / Kett-toruvõti / Верижен тръбен ключ / Lančani ključ za cijevi / Кључ за cevi lančani / Αλυσοκόβουρας σωλήνων / Llave de cadena para tubos / Giratubi a catena / Chave de corrente p. tubos / Clef à chaîne pour tubes / Kettingsleutel voor buizen

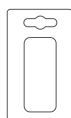

Ref.	L [mm]	Ra [mm/"]	☒	EAN
34D035	300	115/4	6/36	5902062340351

Wykrętki do śrub

Screw extractor set / Schraubendreher / Экстракторы для винтов / Викручувачі зламаних гвинтів / Törtcsavar kihajtó / Set înlăturare șuruburi / Vytahováč šroubů / Súprava vytahovačov zalomenej skrutiek / Garnitura odvijáčev vijakov / Atsuktuvai varžtams / Skrūvju izvilcējs / Kruiemalduskomplekt / Izvijac polomljenih vijaka / Συλλογή μηχανημάτων αφαίρεσης βιδών / Extractores de tornillos / Estrattori di viti / Sacaparafusos / Devisseuses pour vis / Schroevenlosdraaiers



Ref.	Ra[mm]	L[mm]	☒	EAN
09-605	2-10	60	0/50	5907558410341



Ref.	Ra[mm]	Ra[""]	☒	EAN
09-607	3 - 14	1/8 - 1/2	0/20	5907558417241



Ref.	Ra[mm]	☒	EAN
09-609	2, 3, 4, 6.5, 7.5	0/60	5907558416503

Wkrętaki do śrub

Screw extractor set / Schraubendreher / Экстракторы для винтов / Викручувачі зламаних гвинтів / Törtsavar kihajtó / Set înălțurare șuruburi / Vytahováč šroubů / Súprava vytahovačov zložených skrutiek / Garnitura odvíjačov vijakov / Atskukai varžtams / Skrūvju izvilcējs / Kruiemalduskomplekt / Izvijac polomljenih vijaka / Συλλογή μηχανημάτων αφαίρεσης βιδών / Extractores de tornillos / Estrattori di viti / Saca-parafusos / Deviseuses pour vis / Schroevenlosdraaiers

NEO
TOOLS



25
years
GUARANTEE

TÜVRheinland
CERTIFIED

CrMo
steel

x5

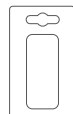

Ref.	Ra[mm]	⊠	EAN
09-615	1/8" (M3-M6), 1/4" (M6-M8), 5/16" (M8-M11), 7/16" (M11-M14), 9/16" (M14-M18)	25/150	5907558416497

T TOPEX



x5

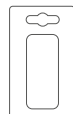

Ref.	∅ [mm]	⊠	EAN
14A110	3,3 - 19,0	10/100	5902062062048

TOP TOOLS



x5

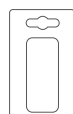

Ref.	∅ [mm]	⊠	EAN
14A105	3,3 - 19,0	10/60	5902062060495

Komplet ściągaczy do szpilek

Roller stud extractor set / Abszieher-set / Набор ключей для снятия шпифтов / Комплект викруток до шпильок / Csap/tűske csavaró szett / Set complet de extractoare pentru / Sada stahovadel na závrtné šrouby / Súprava valčekových stahováčov skrutiek / Komplet smetalcev zatičev / Nuēmējū rinkinys smeigēms / Novilcēju komplekts tapskrūvēm / Vardatāmītsate komplekt / Комплект экстракторов за шпильки / Set skidača za nasadne ključeve / Komplet stega za igle / Set κλειδιά αφαίρεσης πειρών / Juego de extractores para agujas / Set estrattori / Kit de sacadores de pregos / Jeu d'extracteurs de goujon / Set van trekkers voor naalden

NEO
TOOLS



25
years
GUARANTEE

TÜVRheinland
CERTIFIED

CrV
steel

x4

1/2"



Ref.	Ra[mm]	⊠	EAN
09-608	6, 8, 10, 12	0/24	5907558416534

Wkrętak płaski

Screwdriver slotted / Flachschraubendreher / Отвертка плоская / Відкрита плоска / Csavarhúzó lapos / Šrubelnířtá plattá / Šroubovák plochý / Skrutkovač plochý / Ploščati izvijač / Ploščias atsuktuvais / Skrūvgriezis plakans / Lamepea-kruviķeeraja / Отвертка / Odvíjač / Odvijac / Καταβίδι εγκοπής / Destornillador plano / Giravite piatto / Chave de fenda plana / Tournevis à fourche / Vlakke schroevendraaier

NEO
TOOLS

25
years
GUARANTEE

TÜVRheinland
CERTIFIED

S2
steel

oil
resistant

high
HRC
hardness

oil
resistant

high
HRC
hardness

SUPER
BLACK
TIP

TRIANGLE
shape

oil
resistant

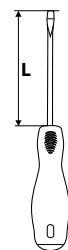

Ref.	∅ [mm]	L [mm]	⊠	EAN
04-011	3,0	75	12/240	5907558401745
04-012	4,0	100	12/240	5907558401752
04-013	5,5	100	12/120	5907558401769
04-014	5,5	200	12/144	5907558401776
04-001	6,5	38	12/288	5907558411638
04-002	6,5	125	12/144	5907558411645
04-015	6,5	150	12/144	5907558401783
04-003	8,0	150	12/120	5907558411652
04-016	8,0	200	12/120	5907558401790
04-004	10,0	200	6/96	5907558411669

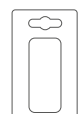

NEO
TOOLS

CrV
steel

TRIANGLE
shape

oil
resistant

oil
resistant

oil
resistant

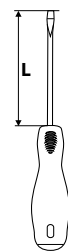

Ref.	∅ [mm]	L [mm]	⊠	EAN
04-171	3,0	75	12/240	5907558440386
04-172	4,0	100	12/240	5907558440393
04-173	5,5	38	12/240	5907558440409
04-174	5,5	100	12/120	5907558440416
04-175	6,5	150	12/120	5907558440423
04-176	8,0	200	6/60	5907558440430

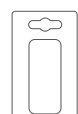

T TOPEX

CrV

oil
resistant

oil
resistant

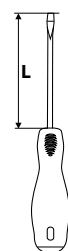

Ref.	∅ [mm]	L [mm]	⊠	EAN
39D801	3,2	75	12/480	5902062398017
39D802	4,0	100	12/360	5902062398024
39D803	5,0	38	12/360	5902062398031
39D804	5,0	100	12/360	5902062398048
39D805	6,5	100	12/240	5902062398055
39D806	6,5	150	12/240	5902062398062
39D807	8,0	150	12/144	5902062398079
39D808	8,0	200	12/96	5902062398086

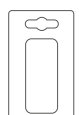

TOP TOOLS

CrV

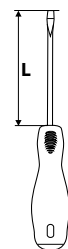

Ref.	∅ [mm]	L [mm]	⊠	EAN
39D640	3,0	75	12/240	5902062396402
39D641	4,0	100	12/240	5902062396419
39D642	5,0	75	12/240	5902062396426
39D643	6,0	100	12/120	5902062396433
39D644	6,0	150	12/120	5902062396440
39D645	8,0	200	12/96	5902062396457

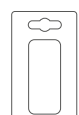

Wkrętak płaski

Screwdriver slotted / Flachschraubendreher / Отвертка плоская / Відкрутка плоска / Csavarhúzó lapos / Šurubelnjā plātā / Šroubovák plochý / Skrutkovač plochý / Ploščati izvijač / Ploščias atsuktavas / Skrūvgriezis plakans / Лампеа-kruvikeeraja / Отвертка / Одвијач / Одвијач / Καταβίβι εγκοής / Destornillador plano / Giravite piatto / Chave de fenda plana / Tournevis à fourche / Vlakke schroevendraaier

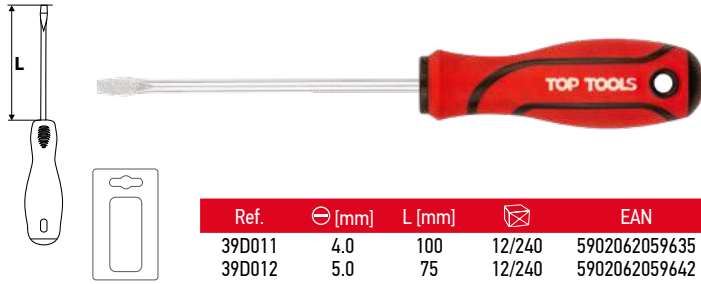

Ref.	⊖ [mm]	L [mm]	📦	EAN
39D011	4.0	100	12/240	5902062059635
39D012	5.0	75	12/240	5902062059642

Wkrętak krzyżowy PH

Screwdriver Phillips / Kreuzschraubendreher / Отвертка крестовая / Відкрутка хрестовидна / Csavarhúzó philips / Šurubelnjā tip „Phillips” / Šroubovák křížový / Skrutkovač PH / Křížni izvijač / Kryžminis atsuktavas Phillips / Skrūvgriezis krusta PH / Ristpeakruvikeeraja / Отвертка / Одвијач / Одвијач / Καταβίβι σταυρωτό τύπου philips / Destornillador philips / Giravite Phillips / Chave de fenda de cruzeta / Tournevis en croix / Kriusschroevendraaier



Ref.	⊕	L [mm]	📦	EAN
04-021	PH0	75	12/240	5907558401806
04-006	PH1	75	12/240	5907558411683
04-022	PH1	100	12/240	5907558401813
04-023	PH2	38	12/288	5907558401820
04-024	PH2	100	12/120	5907558401837
04-007	PH2	150	12/180	5907558411713
04-025	PH2	200	12/144	5907558401844
04-026	PH3	150	12/120	5907558401851

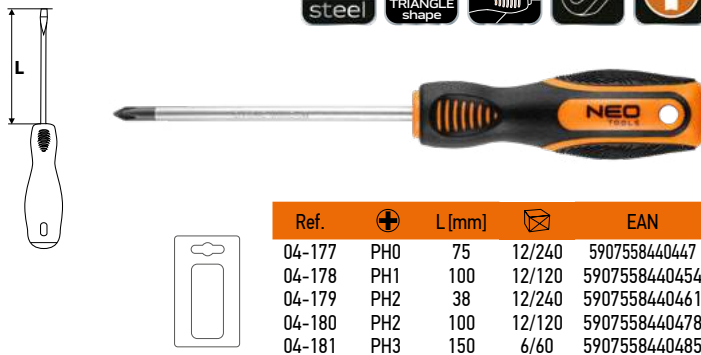

Ref.	⊕	L [mm]	📦	EAN
04-177	PH0	75	12/240	5907558440447
04-178	PH1	100	12/120	5907558440454
04-179	PH2	38	12/240	5907558440461
04-180	PH2	100	12/120	5907558440478
04-181	PH3	150	6/60	5907558440485

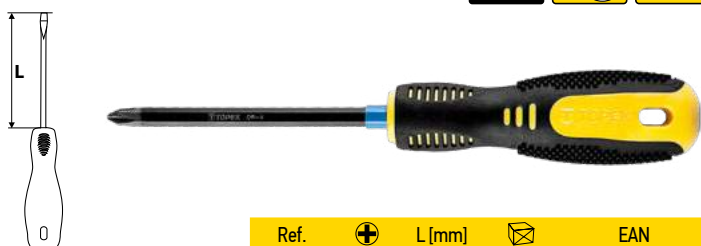

Ref.	⊕	L [mm]	📦	EAN
39D820	PH0	75	12/480	5902062398208
39D821	PH1	100	12/360	5902062398215
39D822	PH2	38	12/360	5902062398222
39D823	PH2	100	12/240	5902062398239
39D824	PH2	150	12/144	5902062398246
39D825	PH3	150	12/144	5902062398253

Wkrętak krzyżowy PH

Screwdriver Phillips / Kreuzschraubendreher / Отвертка крестовая / Відкрутка хрестовидна / Csavarhúzó philips / Šurubelnjā tip „Phillips” / Šroubovák křížový / Skrutkovač PH / Křížni izvijač / Kryžminis atsuktavas Phillips / Skrūvgriezis krusta PH / Ristpeakruvikeeraja / Отвертка / Одвијач / Одвијач / Καταβίβι σταυρωτό τύπου philips / Destornillador philips / Giravite Phillips / Chave de fenda de cruzeta / Tournevis en croix / Kriusschroevendraaier



Ref.	⊕	L [mm]	📦	EAN
39D650	PH0	75	12/240	5902062396501
39D651	PH1	75	12/240	5902062396518
39D652	PH2	100	12/120	5902062396525
39D653	PH3	150	12/96	5902062396532

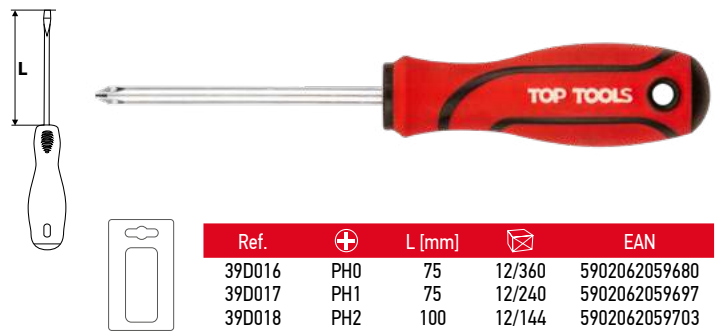

Ref.	⊕	L [mm]	📦	EAN
39D016	PH0	75	12/360	5902062059680
39D017	PH1	75	12/240	5902062059697
39D018	PH2	100	12/144	5902062059703

Wkrętak krzyżowy PZ

Screwdriver Pozidriv / Kreuzschraubendreher / Отвертка крестовая / Відкрутка хрестовидна / Csavarhúzó pozidriv / Šurubelnjā tip „Pozidriv” / Šroubovák křížový / Skrutkovač PZ / Křížni izvijač / Kryžminis atsuktavas Phillips / Skrūvgriezis krusta PZ / Ristpeakruvikeeraja Pozidriv / Отвертка / Одвијач / Одвијач / Καταβίβι τύπου pozidriv / Destornillador philips / Giravite Pozzi / Chave de fenda de cruzeta / Tournevis en croix / Kriusschroevendraaier



Ref.	⊕	L [mm]	📦	EAN
04-031	PZ0	75	12/600	5907558401868
04-032	PZ1	100	12/120	5907558401875
04-033	PZ2	38	12/288	5907558401882
04-034	PZ2	100	12/144	5907558401899
04-035	PZ2	200	12/144	5907558401905
04-036	PZ3	150	12/120	5907558401912



Ref.	⊕	L [mm]	📦	EAN
04-182	PZ0	100	12/240	5907558440492
04-183	PZ1	100	12/120	5907558440508
04-184	PZ2	100	12/120	5907558440515
04-185	PZ3	150	6/60	5907558440522

Wkrętak krzyżowy PZ

Screwdriver Pozidriv / Kreuzschraubendreher / Отвертка крестовая / Відкрутка хрестовидна / Csavarhúzó pozidriv / Šurubelnjiti tip „Pozidriv“ / Šroubovák křížový / Skrutkovač PZ / Křížni izvijač / Kryžminis atsuktuvus Phillips / Skrūvgriezis krusta PZ / Ristpeakruvikeeraja Pozidriv / Отвертка / Odvijač / Odvijac / Kαταβίβι τύπου pozidriv / Destornillador phillips / Giravite Pozzi / Chave de fenda de cruzeta / Tournevis en croix / Kriusschroevendraaier

TOPEX

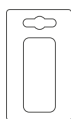
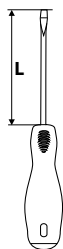

Ref.	Tip	L [mm]	Box	EAN
39D829	PZ0	100	12/360	5902062045492
39D830	PZ1	100	12/360	5902062398307
39D831	PZ2	100	12/144	5902062398314
39D832	PZ2	150	12/144	5902062398321
39D833	PZ3	150	6/96	5902062398338

TOP TOOLS

CrV

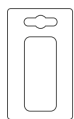
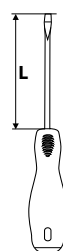

Ref.	Tip	L [mm]	Box	EAN
39D655	PZ1	75	12/240	5902062396556
39D656	PZ2	100	12/120	5902062396563

TOP TOOLS

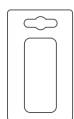
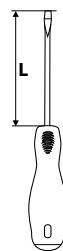
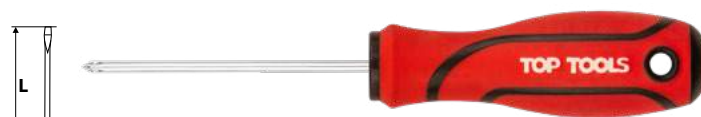

Ref.	Tip	L [mm]	Box	EAN
39D019	PZ1	75	12/240	5902062059710

Wkrętak płaski do pobijania

Slotted screwdriver go through / Schraubendreher, flach / Отвертка шлицевая ударная / Викрутка плоска, ударна / Csavarhúzó üthető lapos / Surubelnjiti impact varf drept / Šroubovák ploché úderový / Sekací ploché skrutkovač / Ploščati izvijač za zabijanje / Smāginis, plokščias atsuktuvus / Plakanais skrūvgriezis / Lame löökkruvikeeraja / Отвертка плоская ударная / Plosnati odvijač za nabijanje / Pljosnati odvijač za zabijanje / Kαταβίβι κρούσης ενίπεδο / Destornillador plano de golpe / Giravite passante piatto / Chave de fenda plano p. malhar / Tournevis à fourche à frapper / Vlakke slagschroevendraaier

NEO TOOLS

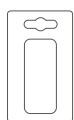
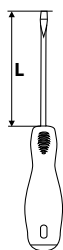

Ref.	Tip [mm]	L ₁ [mm]	Box	EAN
04-019	6,5	125	12/144	5907558403251
04-020	8,0	150	6/96	5907558403268

Wkrętak Torx

Torx screwdriver / Schraubendreher Torx / Отвертка Torx / Викрутка «Torx» / Csavarhúzó torx / Surubelnjiti varf Torx / Šroubovák Torx / Skrutkovač Torx / Izvijač Torx / Atsuktuvus, torcinis / Torx skrūvgriezis / Torx-kruvikeeraja / Отвертка Torx / Odvijač Torx / Odvijac Torx / Kαταβίβι Torx / Destornillador con punta torx / Giravite Torx / Chave de fenda Torx / Tournevis Torx / Torx schroevendraaier

NEO TOOLS

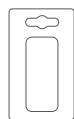
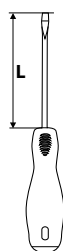

Ref.	Tip	L [mm]	Box	EAN
04-043	T10	100	12/120	5907558401929
04-044	T15	100	12/240	5907558401936
04-045	T20	100	12/240	5907558401943
04-046	T25	100	12/144	5907558401950

NEO TOOLS

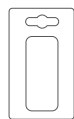
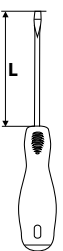

Ref.	Tip	L [mm]	Box	EAN
04-186	T10	100	12/120	5907558440539
04-187	T15	100	12/240	5907558440546
04-188	T20	100	12/240	5907558440553
04-189	T25	100	12/144	5907558440560
04-190	T27	100	12/144	5907558440577

TOPEX

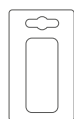
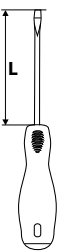

Ref.	Tip	L [mm]	Box	EAN
39D840	T6	60	12/480	5902062398406
39D842	T10	100	12/240	5902062398420
39D843	T15	100	12/240	5902062398437
39D844	T20	100	12/240	5902062398444
39D845	T25	100	12/240	5902062398451
39D846	T27	100	12/144	5902062398468

TOPEX

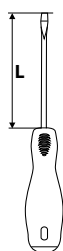

Ref.	Tip [mm]	L [mm]	Box	EAN
39D250	5,0	75	12/144	5902062053282
39D251	6,0	100	12/96	5902062053299
39D252	6,0	125	12/96	5902062053305
39D253	6,0	150	12/96	5902062053312
39D254	8,0	200	12/48	5902062053329
39D255	8,0	250	12/48	5902062053336
39D256	8,0	300	12/48	5902062053343

Wkrętak krzyżowy do pobijania

Screwdriver go through phillips / Kreuzschraubendreher zum Klopfen / Отвертка крестовая усиленная ударная / Відкрутка хрестовидна ударна / Csavarhúzó üthető phillips / Šurubelnija cruciulija p/u spargere / Šraubováč křížový úderový / Skrutkovač úderový PHillips / Ploščati izvijač, udarni / Kryžminis, smūginis atsuktuvas / Skrutvgriezis krusta PH sitiena / Ristpeakruvikeeraja / Отвертка / Одвијач / Одвијач / Σταυρωτό καταβίβι / τίνου phillips / Destornillador de golpe phillips / Giravite passante Phillips / Chave de fenda de cruzeta p. malhar / Tournevis en croix à frapper / Slagkriusschroevendraaier

NEO TOOLS

25 years GUARANTEE

TÜVRheinland CERTIFIED

S2 steel

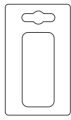
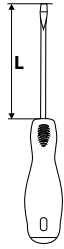

Ref.	+	L[mm]	⊠	EAN
04-028	PH2	100	12/144	5907558403282

TOPEX

CrV

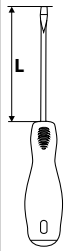

Ref.	+	L[mm]	⊠	EAN
39D260	PH1	75	12/144	5902062053350
39D261	PH2	100	12/96	5902062053367
39D263	PH2	150	12/96	5902062053374
39D264	PH3	200	12/48	5902062053381

Wkrętaki do pobijania

Go through screwdrivers / Schraubendreher zum Aufheben / Отвертки ударные / Вкрутки ударні / Csavarhúzókészlet üthető / Surubelnita de impact / Šraubováky úderové / Sekacie skrutkovače / Izvijači za zabijanje / Smūginiai suktuvai / Triecienskrūvgrieži / Löökrvivikeerjad / Ударни отвертки / Одвијачи за набijaње / Одвијаče за забijaње / Καταβίβια κρούσης / Destornilladores de golpe / Set giraviti passante / Chaves de fenda p. malhar / Tournevis à frapper / Slagschroevendraaiers

NEO TOOLS

25 years GUARANTEE

TÜVRheinland CERTIFIED

S2 steel

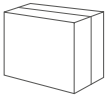

⊖ 5.5x100mm; 6.5x125mm; 8x150mm
⊕ PH1x75; PH2x100



Ref.	⊠	EAN
04-240	12/24	5907558412857

TOPEX

CrV



x6

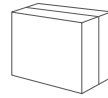

⊖ 5x75mm; 6x100mm; 6x125mm; 8x150mm
⊕ PH1x75mm; PH2x100mm



Ref.	⊠	EAN
39D504	6/12	5902062395047

TOPEX

CrV



Ergo design



x6



⊖ 5x100mm; 5x150mm; 6x150mm
⊕ PH1x100mm; PH1x150mm; PH2x150mm



Ref.	⊠	EAN
39D506	6/24	5902062395061

TOP TOOLS

x6

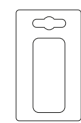

⊖ 5x75mm; 5x100mm; 6x150mm; 6x200mm
⊕ PH2x75mm; PH2x100mm



Ref.	⊠	EAN
39D104	0/50	5902062050298

Wkręćaki

Screwdriver set / Schraubendreher / Отвертки / Відкрутки, набір / Csavarhúzókészlet / Set şurubelişte / Šroubováky / Súprava skrutkovačov / Garnitura izvijačev / Atsuktuvai / Skrivngriežu komplekts / Krivikeerajate komplekt / Отвертки компл. / Odvijaci / Odvijac set / Συλλογή από καταβίβια / Destornilladores / Set giraviti / Chaves de fenda / Tournevis / Schroevendraaiers

NEO TOOLS



⊖ 6x125 mm; 5x100 mm; 3x75 mm
⊕ PH2x125 mm; PH1x100 mm; PH0x75 mm

Ref. 04-213 6/24 EAN 5907558432220

NEO TOOLS



⊖ 8x150; 6.5x125; 5.5x100; 6.5x38 mm
⊕ PH2x125; PH1x100; PH0x75; H2x38 mm

Ref. 04-207 6/12 EAN 5907558422177

NEO TOOLS



⊖ 5.5x75 mm, 6.5x100 mm
⊕ PH1x75 mm, PH2x100 mm

Ref. 04-204 6/36 EAN 5907558402254

NEO TOOLS



⊖ 6.5x150; 6.5x125; 5.5x100; 3x75 mm
⊕ PH2x125, PH1x100; PH0x75 mm

Ref. 04-206 6/24 EAN 5907558422214

NEO TOOLS



⊖ 4x250mm, 5.5x250mm
⊕ PH1x250mm, PH2x250mm

Ref. 04-214 6/24 EAN 5907558435627

NEO TOOLS



⊖ 6.5x150mm; 5.5x100mm; 3x75mm; 5.5x38mm; 6.5x38 mm
⊕ PH2x150mm; PH1x100mm; PH0x75mm; PH2x38mm

Ref. 04-208 6/12 EAN 5907558422221

Wkręćaki

Screwdriver set / Schraubendreher / Отвертки / Відкрутки, набір / Csavarhúzókészlet / Set şurubelniçe / Šroubováky / Súprava skrutkovačov / Garnitura izvijačev / Atsuktuvai / Skrūvgriežu komplekts / Kruvikeerajate komplekt / Отвертки компл. / Odvijaci / Odvijac set / Συλλογή από καταβίδια / Destornilladores / Set giraviti / Chaves de fenda / Tournevis / Schroevendraaiers

NEO
TOOLS



⊖ 5x250 mm, 4x250 mm
⊕ PH2x250 mm, PH1x250 mm

Ref. EAN
04-191 6/24 5907558442656

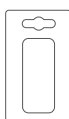

NEO
TOOLS



⊖ 3.0x75mm, 5.5x100mm, 6.5x150mm
⊕ PH1x100mm, PH2x150mm

Ref. EAN
04-192 6/24 5907558442663



NEO
TOOLS



⊖ 5.5x38mm, 5.5x100mm, 6.5x150mm
⊕ PH1x100mm, PH2x38mm, PH2x150mm

Ref. EAN
04-193 6/24 5907558442670

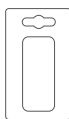

NEO
TOOLS



⊖ 2x50mm; 2.4x50mm; 6.5x38mm; 6.5x100mm
⊕ PH0x50mm; PH1x50mm; PH2x100mm; PH2x38mm

Ref. EAN
04-194 6/24 5907558442687



T TOPEX



⊖ 3.2x75mm; 5x100mm, 6.5x150mm
⊕ PH1x100mm; PH2x150mm

Ref. EAN
39D885 6/36 5902062398857

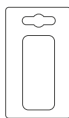

T TOPEX



⊖ 5 x 100 mm; 6.5 x 100 mm
⊕ PH1 x 100 mm; PH2 x 150 mm

Ref. EAN
39D884 6/36 5902062398840

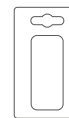

Wkręćaki

Screwdriver set / Schraubendreher / Отвертки / Відкрутки, набір / Csavarhúzókészlet / Set surubelniče / Šraubováky / Súprava skrutkovačov / Garnitura izvijačev / Atsuktuvai / Skrivgriežu komplekts / Krivikeerajate komplekt / Отвертки компл. / Odvijaci / Odvijac set / Συλλογή από καταβίδια / Destornilladores / Set giraviti / Chaves de fenda / Tournevis / Schroevendraaiers

TOPEX



CrV

x6



- ⊖ 5x38mm; 5x100mm; 6.5x150mm
- ⊕ PH1x100mm; PH2x38mm; PH2x150mm

Ref. 39D886 6/36 EAN 5902062398864

TOPEX

CrV

x5



- ⊖ 3.2x75mm; 5x100mm; 6.5x150mm
- ⊕ PH1x100mm; PH2x150mm

Ref. 39D934 0/24 EAN 5902062013934

TOPEX

CrV

x9



- ⊖ 8x200mm; 6.5x100mm; 3.2x100mm
- ⊕ PH2x150mm; PH1x100mm; PH0x100mm
- ⊕ PZ2x150mm; PZ1x100mm; PZ0x100mm

Ref. 39D930 0/12 EAN 5902062013897

TOPEX

CrV

x8



- ⊖ 2x50mm; 2.4x50mm; 6x38mm; 6.5x100mm
- ⊕ PH0x50mm; PH1x50mm; PH2x100mm; PH2x38mm

Ref. 39D888 6/24 EAN 5902062398888

TOPEX

CrV

x4



- ⊖ 3.2x100mm; 6.5x125mm
- ⊕ PH1x75mm; PH2x100mm

Ref. 39D933 0/36 EAN 5902062013927

TOP TOOLS



x2

- ⊖ 6x38mm
- ⊕ PH1x38mm

Ref. 39D174 12/96 EAN 5902062002716

TOP TOOLS



x2

- ⊖ 6x100mm
- ⊕ PH2x100mm

Ref. 39D179 25/50 EAN 5902062052995

Wkrętaki

Screwdriver set / Schraubendreher / Отвертки / Відкрутки, набір / Csavarhúzókészlet / Set šurubelnič / Šroubováky / Súprava skrutkovačov / Garnitura izvijačev / Atsuktuvai / Skrivngriežu komplekts / Krivikeerajate komplekt / Отвертки компл. / Odvijaci / Odvijac set / Συλλογή από καταβίβια / Destornilladores / Set giraviti / Chaves de fenda / Tournevis / Schroevendraaiers

TOP TOOLS



x5

CrV

⊖ 4x100mm; 5x125mm; 6x150mm
⊕ PH1x100mm; PH2x125mm



Ref. 39D503
EAN 5902062395030

TOP TOOLS

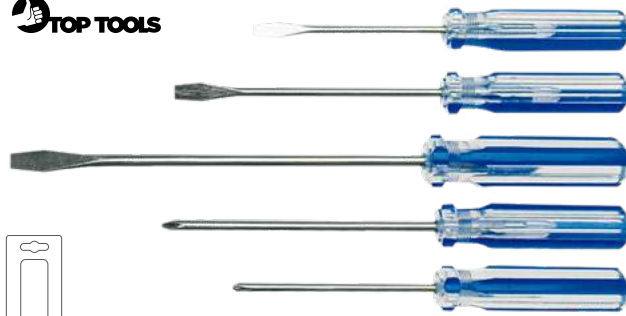

x5



⊖ 4x75mm; 5x100mm; 5x150mm
⊕ PH1x100mm; PH2x150mm

Ref. 39D105
EAN 5902062050328

TOP TOOLS



x7



⊖ 3x75mm; 4x75mm; 4x100mm; 6x150mm
⊕ PH0x75mm; PH1x100mm; PH2x100 mm

Ref. 39D107
EAN 5902062050311

TOP TOOLS



x6



⊖ 4x75mm; 5x100mm; 5x150mm
⊕ PH0x75mm; PH1x100mm; PH1x150mm

Ref. 39D106
EAN 5902062050304

Wkrętak odwracalny

Reversible screwdriver / Schraubendreher, umwendbar / Отвертка универсальная / Викрутка универсальна, з двома різними знімними наконечниками / Csavarhúzókészlet / Surubelničji cu varf dublu, reversibil / Šroubovák oboustranný / Otáčací skrutkovač / Dvsmerni izvijač / Atsuktuvas su keičiamais antgaliais / Universālais skrūvngriezis / Pāratava peaga krivikeeraja / Универсальная отвертка / Povratni odvijač / Povratni odvijač / Καταβίβι γενικής χρήσης / Destornillador reversible / Giravite reversibile / Chave de fenda reversível / Tournevis réversible / Omkeerbare schroevendraaier

NEO TOOLS



25 years GUARANTEE

CrMo steel



⊖ 6x38 mm
⊕ PH2x38 mm

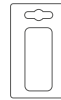

Ref. 04-201
EAN 12/144 5907558402230

TOPEX

CrV x4



⊖ x 4 mm - 6 mm
⊕ x PH1 - PH2
L - 75 mm

Ref. 39D516
EAN 24/72 5902062395160

TOP TOOLS



⊖ 5.5x90 mm
⊕ PH2x90 mm

Ref. 39D177
EAN 20/200 5902062052810

Wkrętaki i końcówki wkrętakowe

Screwdrivers and bits / Schraubendreher und Einsätze für Schraubendreher / Отвертки и насадки / Викрутки и наконечники викруткови / Csavarhúzó és bitkészlet / Set surubelničja ši capete / Šroubováky a šroubovákové nástavce / Skrutkovače a skrutkovačie nástavce / Izvijači in nastavki za izvijače / suktuvai ir antgaliai / Skrivngrieži un to uzgaļi / Krivikeerajad ja krivikeerajatsakud / Отвертки и накрайниці за мая / Odvijaci i nastavci za odvijače / Odvijaci i nastavci za odvijače / Καταβίβια και καταβιδόμπετες / Destornilladores y puntas / Set giraviti e inserti / Chaves de fenda e ponteiros de chave de fenda / Tournevis et embouts de tournevis / Schroevendraaiers en schroevendraaiereindstukken

NEO TOOLS



25 years GUARANTEE

TÜV Rheinland CERTIFIED

S2 steel x30

oil resistant high HRC hardness

TRIANGLE shape

SUPER BLACK TIP

⊖ 8x150; 6.5x125; 5.5x100; 3x75; 2.5x50; 3.0x50 mm
⊕ PH2x125; PH1x75; PH0x50; PH0x50 mm
⊕ T6x50; T7x50; T8x50 mm



4; 5; 6mm; PH1; PH2; PH3; PZ1; PZ2; PZ3; T10; T15; T20; T25; H4; H5; H6

Ref. 04-209
EAN 5/10 5907558422207

Wkrętaki i końcówki wkrętakowe

Screwdrivers and bits / Schraubendreher und Einsätze für Schraubendreher / Отвертки и насадки / Вкрутки і наконечники вкруток / Csavarhúzó és bitkészlet / Set surubelnița și carpe / Šroubováky a šroubovákové nástavce / Skrutkovače a skrutkovacie nástavce / Izvijaci in nastavki za izvijace / skutuvai ir antgaliai / Skrivvgræzi un to uzgali / Krivikeerajad ja krivikeerajatsakud / Отвертки и наконечники за тях / Odvijaci i nastavci za odvijace / Odvijaci i nastavci za odvijace / Καταβίβια και καταβίβιμρες / Destornilladores y puntas / Set giraviti e inserti / Chaves de fenda e ponteiros de chave de fenda / Tournevis et embouts de tournevis / Schroevendraaiers en schroevendraaierinstukken

NEO
TOOLS



- ⊖ 8x150; 6.5x100; 5.5x75; 6.5x38; 2.5x40; 3.0x40 mm
- ⊕ PH3x150; PH2x100; PH1x75; PH2x38; PH00x40; PH0x40 mm
- ⊕ T5x40; T6x40; T7x40; T8x40 mm

4; 5; 6 mm, PH1; PH2; PH3; PZ0; PZ1; PZ2; PZ3,
T10; T15; T20; T25; T30; T40; H3; H4; H5; H6

Ref. 04-210 5/10 EAN 5907558422160

NEO
TOOLS



- ⊖ 6.5x100mm
- ⊕ PH2x100 mm, PH1x75 mm

4, 5, 6 mm; T10, T15, T20, T25, T27, T30, T40

Ref. 04-196 6/24 EAN 5907558442694

T TOPEX



- ⊖ 3.2x38mm; 5x100mm, 6.5x150mm
- ⊕ PH1x100mm; PH2x150mm

4.5, 6, 7mm; PH0, PH1, PH2, PH3; T10, T15,
T20, T25, T27, T30, T40; H2, H3, H4, H5, H6

Ref. 39D887 6/12 EAN 5902062398871

NEO
TOOLS



- ⊖ 6.5x125; 5.5x100; 6.5x38; 2.5x50; 2.0x50 mm
- ⊕ PH2x125; PH2x100; PH1x75; PH2x38; PH00x50; PH0x50 mm
- ⊕ T5x50; T6x50; T7x50; T8x50; T9x50; T10x50 mm

3; 3; 4; 4; 5; 5 6, 6 mm; PH0; PH0; PH1; PH1; PH2; PH2; PH3;
PH3; T10; T10; T15; T15; T20; T20; T25; T25; T27; T27; T30;
T30; H2; H2; H2.5; H2.5; H3; H3; H4; H4; H5; H5; H6; H6

Ref. 04-211 6/12 EAN 5907558422191

NEO
TOOLS



- ⊖ 3x75mm, 4x100 mm, 5.5x100mm, 6.5x150mm
- ⊕ PH1x100mm, PH2x150mm

4.5; 6; 7 mm; PH0, PH1, PH2, PH3; T10, T15,
T20, T25, T27, T30, T40; H2, H3, H4, H5, H6

Ref. 04-197 6/12 EAN 5907558442700

T TOPEX



- ⊖ 6.5x100mm
- ⊕ PH1x100mm, PH2x100mm

4, 5, 6 mm; T10, T15, T20, T25, T27, T30, T40

Ref. 39D890 6/24 EAN 5902062023148

Wkrętak precyzyjny płaski

Slotted precision screwdriver / Feinschraubendreher, flach / Отвертка прецизионная шлицевая / Вкрутка прецизиона, плоска / Műszerész csavarhúzó / Surubelnitja de precizie, varf drept / Šroubovák precizní ploché / Precizny plochy skrutkovač / Precizni ploščati izvijač / Atsuktuvus plokščias, torcinis / Precizėjošais plakanais skrūvgriezis / Lame peenkruvikeeraja / Отвертка плоска прецизна / Precizni plosnati odvijač / Precizni plosnati odvijač / Καταβίδι ακριβείας επίπεδο / Destornillador plano de precisión / Giravite di precisione piatto / Chave de fenda precisa plano / Tournevis de précision à fourche / Vakke fijn Schroevendraaier

NEO
TOOLS



Ref.	⊖ [mm]	L [mm]	📦	EAN
04-112	2,0	50	12/240	5907558435511
04-113	2,5	50	12/240	5907558435528
04-114	3,0	50	12/240	5907558435535

Wkrętak precyzyjny krzyżowy PH

Cross slotted precision screwdriver / Feinschraubendreher, Kreuz / Отвертка прецизионная крестовидная / Вкрутка прецизиона, крестовидна / Műszerész csavarhúzó / Surubelnitja de precizie, varf cruce / Šroubovák precizní křížový / Precizny krížový skrutkovač / Křížni precizni izvijač / Atsuktuvus precizinis, kryžminis / Precizėjošais krustveida skrūvgriezis / Lame ristpeakruvikeeraja / Отвертка прецизна кръстата / Precizni křížni odvijač / Precizni kukasti odvijač / Σταυροκατάβίδο ακριβείας / Destornillador de precisión phillips / Giravite di precisione Phillips / Chave de fenda precisa de cruzeta / Tournevis de précision en croix / Fijnkrusschroevendraaier

NEO
TOOLS



Ref.	⊕	L [mm]	📦	EAN
04-115	2,0	50	12/240	5907558435511
04-116	2,5	50	12/240	5907558435528
04-117	3,0	50	12/240	5907558435535

TOPEX



Ref.	⊖ [mm]	L [mm]	📦	EAN
39D771	2.5	50	75/300	5902062397713
39D772	3	50	75/300	5902062397720

TOPEX



Ref.	⊕	L [mm]	📦	EAN
39D773	PH0	50	75/300	5902062397737
39D774	PH00	50	75/300	5902062397744

Wkrętaki precyzyjne

Precision screwdriver set / Präzisionsschraubendreher / Отвертки прецизионные / Відкрутки прецизи́ні, набір / Műszerész csavarhúzókészlet / Set surubelnite / Šroubováky jemná mech. / Súprava mikroskrutkovačov / Garnitura natančnih izvijačev / Atsuktuvai tiksliems darbams / Skrūvgriežu komplekts / Тарпскрувикееряте комплект / Отвертки компл. / Одвijač / Одвijač set / Συλλογή καταβιδιών ακριβείας / Destornilladores de precisión / Set giraviti di precisione / Chaves de fenda precisas / Tournevis de précision / Fijn Schroevendraaiers

NEO
TOOLS



- ⊖ 1.5x40 mm, 2.0x40 mm, 2.5x40 mm
- ⊕ PH00x40 mm, PH0x40 mm

Ref.	📦	EAN
04-225	6/24	5907558402285

NEO
TOOLS



- ⊖ 1.5, 2.0, 3.0 mm
- ⊕ PH000, PH00, PH0
- ⊕ T5, T6, T7, T8
- H1.5, H2.0, H2.5, H3.0

Ref.	📦	EAN
04-227	6/24	5907558402308

TOPEX



- ⊖ x ⊕ 1.5 mm x T5; 2 mm x T6; 3 mm x T7
- ⊕ x ⊕ PH000 x T8; PH00 x T9; PH0 x T10

Ref.	📦	EAN
39D551	12/72	5902062053237

TOPEX



- ⊖ 2.0 x 50 mm; 2.5 x 50 mm; 3.0 x 50 mm
- ⊕ PH00 x 50 mm; PH0 x 50 mm
- T8 x 50 mm; T10 x 50 mm

Ref.	📦	EAN
39D552	10/80	5902062053220

Wkrętaki precyzyjne

Precision screwdriver set / Präzisionsschraubendreher / Отвертки прецизионные / Відкрутки прецизійні, набір / Műszerész csavarhúzókészlet / Set şurubelniçe / Šroubováky jemná mech. / Súprava mikroskrutkovačov / Garnitura natančnih izvijačev / Atsuktuvai tikslieks darbars / Skrivngriežu komplekts / Täppiskruvikeerajate komplekt / Отвертки комп. / Odvijač / Odvijač set / Συλλογή καταβιδιών ακριβείας / Destornilladores de precisión / Set giraviti di precisione / Chaves de fenda precisas / Tournevis de précision / Fijnschroevendraaiers

T TOPEX

CrV **x7**

T TOPEX

CrV **x6**



- ⊖ 1.5 x 50 mm; 2.0 x 50 mm; 2.5 x 50 mm
- ⊕ PH00 x 50 mm; PH0 x 50 mm
- ⊖ T5 x 50 mm; T6 x 50 mm

Ref. 39D558 10/50 EAN 5902062395580



- ⊖ 1.4 mm; 2.0 mm; 2.4 mm
- ⊕ PH00; PH0; PH1

Ref. 39D559 10/60 EAN 5902062395597

TOP TOOLS



x6

- ⊖ 1, 1.2, 1.8, 2.4 mm
- ⊕ PH0, PH1

Ref. 39D193 20/200 EAN 5902062050380

TOP TOOLS



x11

- ⊖ 0.9x23mm, 1.2x23mm, 1.4x24mm, 1.8x24mm, 2.4x25mm, 3.0x29mm
- ⊕ PH00x23mm, PH0x26mm, PH1x27mm, AWL x 27 mm
- AWL x 27 mm

Ref. 39D194 0/100 EAN 5902062053084

Końcówki wkrętakowe precyzyjne z uchwytem

Precision screwdriver bits with holder / Einsätze für Schraubendreher, fein mit Aufnahm / Набор насадок прецизионных с держателем / Насадки викруткові, прецизійні, з руків'ям / Preciziós csavarhúzóbetétek tartóval / Set maner si biti, precizie / Šroubovákové nástavce precizní s držadlem / Skrutkovacie nástavce precízne s upínadlom / Nastavki za precizni izvijač z vpenjalom / Atsuktuvo antgaliai, preciziniai su laikikliu / Precizėjeišu užgaļu komplekts ar turētāju / Peenkruikeerajaotsakud koos käepidemega / Комплект прецизни накрайниці за отвертка с държач / Precizni nastavi cza odvijač s hvataljkom / Nastavci za precizni odvijač s drškom / Σετ με καταβιδόμετες ακριβείας και προσαρμογέα / Puntas destornilladoras de precisión con mango / Inserti di precisione per avvitare con impugnatura / Ponteiros chave de fenda precisos com suporte / Embouts de tournevis de précision avec manche / Fijnschroevendraaiereindstukken met handvat

NEO TOOLS

CrV **PRECISION** **x53**
steel set

NEO TOOLS

25 **TÜVRheinland** **CrMo** **x17** **5/32"**
years GUARANTEE CERTIFIED steel



- ⊖ 4; 4.5; 5; 5.5; 6; 7 mm
- ⊖ 2.5; 3; 3.5; 4; 4.5; 5; 5.5 mm
- ⊖ 1; 1.5; 2; 2.5; 3; 3.5; 4 mm
- ⊕ 1; 1.5; 2; 2.5; 3.5
- ⊕ T3; T4; T5; T6; T7; T8; T9; T10; T15; T20
- ⊕ H0.9; H1.3; H1.5; H2; H2.5; H3; H3.5; H4
- ⊕ Y0.8; Y2 ⚙ 2 ⚙ 0.8
- ⊕ U2.6 ⚙ SIMIN 0.8 ⚙ 1.5

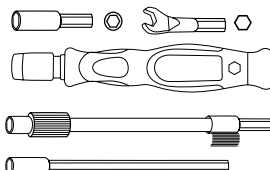

Ref. 06-111 20/40 EAN 5907558431889



- ⊖ 2.0, 2.5, 3.0 mm
- ⊕ PH00, PH0, PH1, PZ00, PZ0
- ⊕ T6, T7, T8, T9, T10
- ⊕ H1.5, H2.0, H2.5

Ref. 04-228 6/36 EAN 5907558410068

Końcówki wkrętakowe precyzyjne z uchwytem

Precision screwdriver bits with holder / Einsätze für Schraubendreher, fein mit Aufnahme / Набор насадок прецизионных с держателем / Насадки викрутковой, прецизионной, з рукояткой / Precíziós csavarhúzóbetétek tartóval / Set maner si biti, precizie / Šroubovácové nástavce precízní s držadlem / Skrutkovacie nástavce precízne s uchytením / Nastavki za precízní izvijač z vpenjalom / Atsuktuvo antgaliai, preciziniai su laikikliu / Precižjošu uzgaļu komplekts ar turētāju / Peenkrvivkeeraajatsakud koos käepidemega / Комплект прецизни накрайници за отвертка с держач / Precizni nastavi cza odvijač s hvataljkom / Nastavci za precizni odvijač s drškou / Set me katastibódimites akribéias kai proasarmouéa / Puntas destornilladoras de precisión con mango / Inserti di precisione per avvitare con impugnatura / Ponteiros chave de fenda precisos com suporte / Embouts de tournevis de précision avec manche / Fijnschroevendraaierinstukken met handvat

NEO
TOOLS

CrV steel UNIVERSAL set x73



6.3 x 25 mm

4 x 28 mm

3; 4; 5; 6; 7

1; 1.5; 2; 2.5; 3; 3.5; 4

4; 5; 6; 6.5

1; 1.5; 2; 2.5; 3.5

T9; T10; T15; T20; T25; T30

T3; T4; T5; T6; T7; T8; T9; T10; T15; T20

H2.5; H3; H4; H5; H6

H0.9; H1.3; H1.5; H2; H2.5; H3; H3.5; H4; H4.5; H5; H6

PZ1; PZ2; PZ3

Y2

Y1; Y2; Y3

U2.6

U6; U8

0.8

2.3

2; 2.3

R1

Ref. 06-115 EAN 5907558431896

NEO
TOOLS

CrV steel UNIVERSAL set x69



6.3 x 25 mm

4 x 28 mm

3; 4; 5; 6; 7

1; 1.5; 2; 2.5; 3; 3.5; 4

4; 5; 6; 6.5

1; 1.5; 2; 2.5; 3.5

T9; T10; T15; T20; T25; T30

T3; T4; T5; T6; T7; T8; T9; T10; T15; T20

H2.5; H3; H4; H5; H6

H0.9; H1.3; H1.5; H2; H2.5; H3; H3.5; H4; H4.5; H5; H6

PZ1; PZ2; PZ3

Y2

Y1; Y2; Y3

U2.6

U6; U8

0.8

2.3

2; 2.3

R1

Ref. 06-116 EAN 5907558431902

TOPEX

CrV x32



1; 1.5; 2; 2.5; 3; 3.5; 4 mm
PH00; PH00; PH0; PH1
PZ0; PZ1
T4; T5; T6; T7; T8; T9; T10; T15; T20
H0.7; H0.9; H1.3; H1.5; H2; H2.5; H3; H4



Ref. 39D555 EAN 5902062053275

TOPEX

CrV x37 x28 28 [mm] x7



100 mm

1, 1.5, 2.0, 2.5, 3.0, 3.5 mm
PH000, PH00, PH0, PH1
PZ0, PZ1
T4, T5, T6, T7, T8, T9, T10, T15, T20
H0.7, H0.9, H1.3, H2, H2.5, H3, H4

2.5, 3, 3.5, 4, 4.5, 5, 5.5 mm

Ref. 39D343 EAN 5902062034182

TOP TOOLS

CrV x7 LED



25 MM

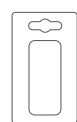

Ref. 39D197 EAN 5902062035738

Zestaw do serwisowania smartfonów

Smartphone repair kit / Smartphone-Service-Set / Набор для ремонта смартфонов / Набор для ремонту смартфонів / Okostelefon javító készlet / Set de servisarea smartphoane-uri / Servisní sada pro smarthyony / Súprava na opravu smartfónov / Komplet za servisiranje pametnih telefonov / Rinkiny smartfonų remontui / Smartfonų apkopės komplekts / Nutitefonide hoolduskomplekt / Комплект за поддръжка на смартфони / Set za servisiranje smartfona / Komplet za servisiranje pametnih telefona / Σετ επισκευής κινητών smartphone / Juego para reparación de smartphones / Completo per manutenzione smartphone / Jogo de ferramentas para smartphones / Kit de maintenance pour smartphone

NEO
TOOLS



CrV
steel

PRECISION
set

x47

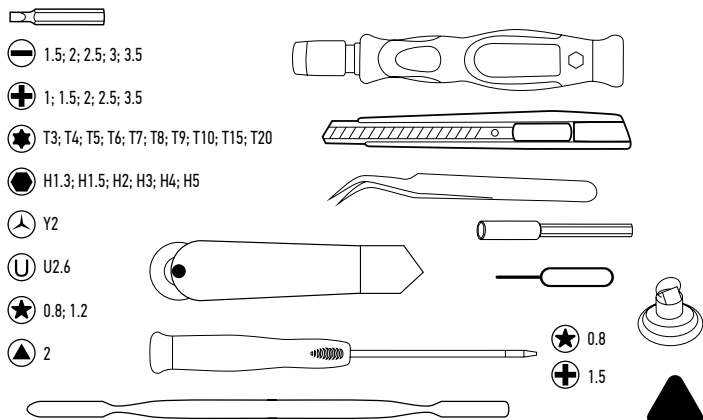

1.5; 2; 2.5; 3; 3.5

1; 1.5; 2; 2.5; 3.5

T3; T4; T5; T6; T7; T8; T9; T10; T15; T20

H1.3; H1.5; H2; H3; H4; H5

Y2

U2.6

0.8; 1.2

2

Ref. 06-112 0/20 EAN 5907558431919

NEO
TOOLS



CrV
steel

PRECISION
set

x47

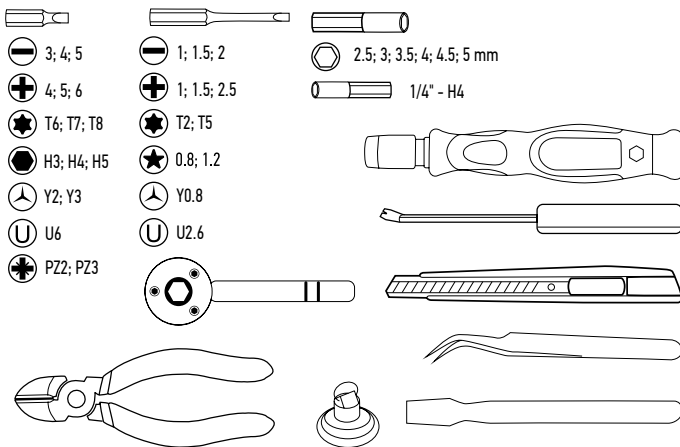

3; 4; 5

4; 5; 6

T6; T7; T8

H3; H4; H5

Y2; Y3

U6

PZ2; PZ3

1; 1.5; 2

1; 1.5; 2.5

T2; T5

0.8; 1.2

Y0.8

U2.6

2.5; 3; 3.5; 4; 4.5; 5 mm

1/4" - H4

Ref. 06-114 0/20 EAN 5907558431933

NEO
TOOLS



25
years
GUARANTEE

+

+

+

+

+

Ref. 06-108 6/36 EAN 5907558404340

Uniwersalny uchwyt do smartfonów

Universal phone holder / Universeller Smartphone-Halter / Универсальный держатель для смартфонов / Универсальный тримач для смартфонів / Univerzálny okostelefon szerelő állvány / Suport universal pentru smartphone / Univerzálny držák na smartfóny / Univerzální držák pro smartphone / Univerzalno držalo za pametne telefone / Univeršalus išmaniojo telefono laikiklis / Univeršāls viedtālruna turētājs / Univeraalne nutitelefoni hoidja / Универсален държач за смартфон / Univerzalni držač za pametni telefon / Универзални држач за паметни телефон / Καθολική θήκη smartphone / Soporte universal para smartphone / Supporto universale per smartphone / Suporte universal para smartphone / Support universel pour smartphone / Universele smartphonehouder

NEO
TOOLS



Ref. 06-123 20/40 EAN 5907558444759

Szczypce do ekranów

Screen opening tool / Bildschirmzange / Щипцы для экрана / Щипці для екранів / Kijelző Fogó / Clești pentru ecrane / Kliešte na obrazovky / Klešte na obrazovky / Klešče za zaslon / Ekran replės / Ekranā knaibles / Ekraanitangid / Ekranni klešči / Klijēšta za sito / Кљушцита за сито / Πένσες οθόνης / Alicates de pantalla / Pinza a ventosa per schermi / Alicates de tela / Pince à écran / Schermtang /

NEO
TOOLS



Ref. 06-122 40/80 EAN 5907558444742

Chwytnak akcesoriów elektronicznych

Electronic accessories gripper / Elektronischer Zubehörgreifer / Захваты для электронных принадлежностей / Електронний захоплювач аксесуарів / Rugós csipesz / Accesorii electronice de prindere / Chapadlo elektronického príslušenství / Uchopovač elektronického príslušenstva / Elektronsko prijemalo za dodatno opremo / Elektroninis priedų griebtuvas / Elektroniskais piederumu satvērējs / Elektrooniline tarvikute haarats / Електронен грайфер за аксесоари / Hvataljka za elektronički pribor / Хватач електронске додатне опреме / Πιάτσο ηλεκτρονικών αξεσουάρ / Pinza de accesorios electrónicos / Pinza a ragno / Garra de acessórios eletrônicos / Préhenseur d'accessoires électroniques / Grijper voor elektronische accessoires

NEO
TOOLS

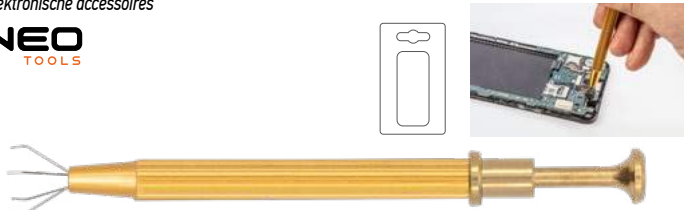

Ref. 06-119 100/200 EAN 5907558444711

Zestaw otwieraków

Opener set / Öffner-Satz / Открывалки набор / Набор інструменту для розкладання / Szétválasztó készlet / Set deschizătoare / Súprava otváračov / Sada otviracih nástrojů / Set odpiral / Atidarymo komplektas / Atvērēju komplekts / Avaja komplekt / Комплект отварачки / Set otvarača / Отварач сеп / Σετ ανοιχτήρι / Juego de abridor / Leve di separazione / Conjunto abridor / Jeu d'ouvreurs / Opener set

NEO
TOOLS



ANTI
STATIC

x6

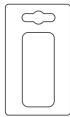

Ref. 06-126
EAN 5907558444780

NEO
TOOLS

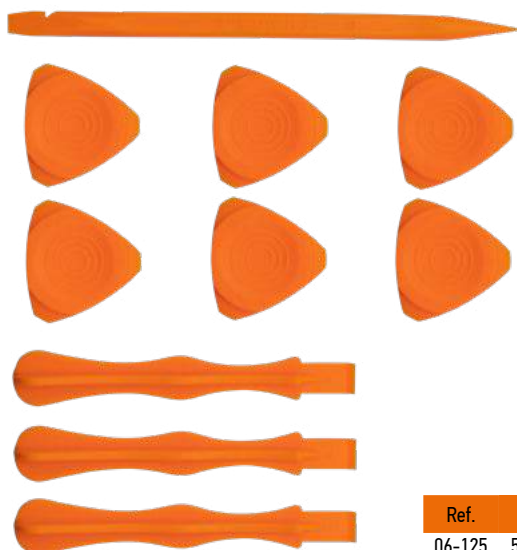

x10

ANTI
STATIC



Ref. 06-125
EAN 5907558444773

NEO
TOOLS



ANTI
STATIC

x13

Ref. 06-127
EAN 5907558444797

Szpatułki

Spudgers / Spateln / Лопатки / Шпатель / Spatula készlet / Spatule / Špachtle / Stierky / Lopatice / Purkštuvai / Spudgers / Pihustid / Спуджеру / Spudgers / Спуджерс / Spudgers / Spudgers / Separatori / Spudgers / Spudgers

NEO
TOOLS

x3

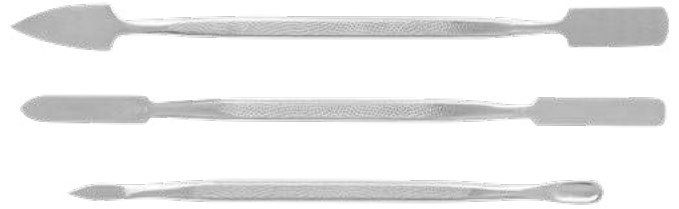

Ref. 06-118
EAN 5907558444704

Pinceta

Tweezers / Pinzette / Пинцет / Пинцет / Csipesz / Pensetä / Pinzeta / Pinzeta / Pinceta / Pincetas / Pincete / Pintsetid / Пинцета / Pinceta / Pinceta / Пинцетки / Pinza / Pinzetta / Pinça / Pincette / Pincet

NEO
TOOLS



Ref. 06-120
EAN 5907558444728

Szko powiększające

Magnifying glass / Lupe / Увеличительное стекло / Збільшувальне скло / Nagytó / Vergrößerungsglas / Lupä / Zväčšujúce sklo / Povečevalno steklo / Didinamasis stiklas / Palielinošais stikls / Suurendusklaas / Лупа / Povečalo / Лупа / Μεγεθυντικός φακός / Lupa / Lente d'ingrandimento / Lente de aumento / Loupe / Vergrotingsglas /

NEO
TOOLS

3xLED light
DPT 2.5x 110 mm
DPT 4x 20 mm
DPT 25x 20 mm
x3 AAA

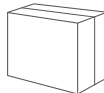

Ref. 06-129
EAN 5907558444810

Soczewki powiększające

Magnifying lenses / Vergrößerungslinsen / Увеличительные линзы / Линзи збільшувальні / Nagytó lencsék / Lentile de mărire / Zvětšovací čočky / Zväčšujúce šošovky / Povečevalne leče / Didinamieji lęšiai / Palielinošās lēcas / Suurendusklaasid / Увеличителни леци / Povečale leče / Повеčала сочєва / Μεγεθυντικοί φακοί / Lentes de aumento / Lenti d'ingrandimento / Lentes de aumento / Lentilles grossissantes / Vergrotende lenzen

NEO
TOOLS

2xLED
light

DPT 1.0x, 1.5x, 2.0x, 2.5x, 3.5x

x2
AAA

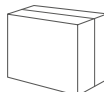

Ref. 06-130
EAN 5907558444827

Mata antystatyczna

Anti-static mat / Antistatische Matte / Антистатический коврик / Кулимон антистатичний / Antisztatikus alátét / Covor antistatic / Antistatična podloga / Antistatičká rohož / Antistatična podloga / Antistatinis kilimėlis / Antistatiska paklājs / Antistaatiline matt / Антистатична постелка / Antistatička prostírka / Антистатична простирна / Ανταστικά χαλίκι / Alfombra antiestática / Tappetino antistatico / Tapete antiestático / Tapis antistatique / Antistatische mat

NEO
TOOLS



Ref.	Box	EAN
06-124	0/40	5907558444766

Opaska magnetyczna

Magnetic band / Magnetische Binde / Магнитный фиксатор / Затискич магнітний / Mágneses karánt / Bandă magnetică / Magnetický držák na zápěstí / Magnetické pásmo / Magnetni pas / Magnetine apurankė / Magnētiskā aproce / Magnetiline käärael / Магнитна зривна / Magnetska narukavica / Магнетна наруквца / Μαγνητικό βραχιόλι / Pulseira magnética / Braccialetto magnetico / Pulseira magnética / Bracelet magnétique / Magnetische polsband

NEO
TOOLS



Ref.	Box	EAN
06-121	40/80	5907558444735

Wkrętak z giętkim grotem

Screwdriver with flexible shank with bits / Schraubendreher mit flex. Spitze / Отвертка с гибким стержнем / Відкрутка з залом на шарпіри / Csavarhúzó készlet flexibilis nyéllel / Şurubeliñiã cu corp flexibil cu viř / Šroubovák s pružným hrotem / Skrutkovač Flexi-Bity / Izvijlač s pregibno konico / Atsuktuvus su lanksčia šerdimi / Skrūvgriezis ar lokano galu uzgaliet / Painduva kâepidemega kruvikeeraja / Отвертка с накраїниці / Odvijac / Καταβίδι με εύκαμπτη λαβή και σετ μπιτών / Destornillador con vástago flexible + puntas / Cacciavite con la punta flessibile / Chave de fenda com ponta flexível / Tournevis à pointe douce / Schroevendraaier met zachte eindstuk

NEO
TOOLS



- 5, 6, 7 mm
- PH1, PH2, PH3, PZ1, PZ2
- T15, T20

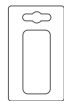

Ref.	Box	EAN
04-212	6/36	5907558402261

NEO
TOOLS

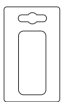
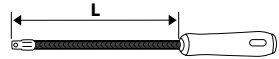

Ref.	L [mm]	Box	EAN
06-079	150	6/120	5907558430622

TOPEX

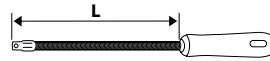

1/4" - 1/4"

L - 25 mm

- 4; 5; 6; 7 mm
- PZ1; PZ2; PZ3
- T10; T15; T20; T30



Ref.	L [mm]	Box	EAN
39D865	190	6/24	5902062398659

TOP TOOLS

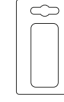

Ref.	Box	EAN
39D122	12/60	5902062053268

Wkrętak teleskopowy z końcówkami

Telescopic screwdriver with bits / Teleskop-Schraubendreher mit Einsätzen / Отвертка с длинным стержнем с насадками / Відкрутка телескопічна з наконечниками / Teleszkópos csavarhúzókészlet / Surubeliñiã telescopică cu capete / Teleskopický šroubovák s nástavci / Teleskopický skrutkovač s nástavcami / Teleskopiskij izvijač z nastavki / Teleskopinis suktuvus su antgaliais / Skrūvgriezis teleskopisks skrūvgriezis ar uzgaliet / Teleskoopkruvikeeraja koos otsakutega / Τελεσκοπική отвертка с накраїниці / Teleskopski odvijac s nastavcima / Teleskopski odvijac s nastavcima / Τηλεσκοπικό καταβίδι με μύτες / Destornillador telescópico con puntas / Giravite telescópico con inserti / Chave de fenda telescópico com ponteiros / Tournevis télescopique avec embouts / Telescopische schroevendraaier met eindstukken

TOP TOOLS

x20



- 4, 5, 6 mm
- PH1, PH2, PH3
- T10, T15, T20, T25, T30,
- H4, H6
- 4, 5, 6, 7, 8 mm

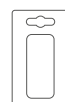

Ref.	L min [mm]	L max [mm]	Box	EAN
39D183	200	500	0/40	5902062053152

Końcówki wkrętakowe z uchwytem

Screwdriver bits with holder / Einsätze für Schraubendreher mit Aufnahme / Набор насадок с держателем / Наконечники викруткові, з рукояттям / Csavarhúzó cserélhető fejjű / Set biti cu suport capat / Šroubovákové nástavce s držadlem / Skrutkovacie nástavce s upínadlom / Nastavki za izvijač z vpenjalom / Atsuktuto angaliia su laikikli / Skrivgrieža uzgaļu komplekts ar turētāju / Krivikeerajatsakud koos käepidemega / Накрайниці за отвертка с держач / Nastavci za odvijač s hvatalikom / Nastavci za odvijač s držkom / Σετ με κατασβιδόμετες και προσαρμογέα / Puntas destornilladoras con mango / Set inserti con supporto / Ponteiros Chave de fenda com Suporte / Embouts de tournevis de précision avec manche / Schroevendraaiereinstukken met handvat

NEO
TOOLS

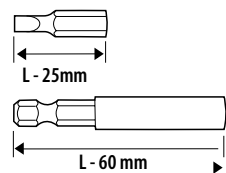

- ⊖ 3, 4, 5, 6 mm
- ⊕ PH1, 2xPH2, PH3
- ⊕ PZ1, 2xPZ2, PZ3
- H3, H4, H5, H6
- T10, T15, T20, T25, T27, T30, T40
- TT10, TT15, TT20, TT25, TT27, TT30, TT40

Ref. 06-103 6/24 EAN 5907558402346

NEO
TOOLS

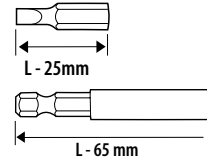

- ⊖ 3, 4, 5, 6 mm
- ⊕ PH1, 2xPH2, PH3
- ⊕ PZ1, 2xPZ2, PZ3
- H3, H4, H5, H6
- T10, T15, T20, T25, T27, T30, T40
- TT10, TT15, TT20, TT25, TT27, TT30, TT40

Ref. 06-106 12/48 EAN 5907558410143

NEO
TOOLS



- ⊖ 3, 4, 4.5, 5.5, 6, 6.5, 7, 8 mm
- ⊕ PH0, PH1, PH2x5, PH3
- ⊕ PZ0, PZ1x2, PZ2x5, PZ3
- T8, T10, T15, T20, T25, T27, T30, T40, T45
- TT8, TT10, TT15, TT20, TT25, TT27, TT30, TT35, TT40
- H1.5, H2, H2.5, H3, H4, H5, H5.5, H6, H8
- H1/16, H5/64, H3/32, H7/64, H1/8, H9/64, H5/32, H3/16, H7/32, H1/4"
- HT2, HT2.5, HT3, HT4, HT5, HT6
- 5/64, 3/32, 7/64, 1/8, 9/64, 5/32"
- M5, M6, M8
- ⊕ 4, 6, 8, 10 mm
- ⊕ 2, 3, 4 mm
- ⊕ 1, 2, 3 mm
- ⊕ 6, 8, 10 mm
- No0, No1, No2, No3

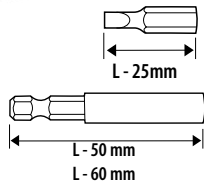

Ref. 06-104 6/24 EAN 5907558406245

NEO
TOOLS



- ⊖ 3, 4, 5, 6 mm
- ⊕ PH1x2, PH2x2, PH3x2
- ⊕ PZ1x2, PZ2x2, PZ3x3
- T10, T15, T20, T25, T27, T30, T40
- TT10, TT15, TT20, TT25, TT27, TT30, TT40
- H2, H2.5, H3, H4, H5, H6

Ref. 06-105 6/36 EAN 5907558402315

Końcówki wkrętakowe z uchwytem

Screwdriver bits with holder / Einsätze für Schraubendreher mit Aufnahme / Набор насадок с держателем / Наконечники викруткови, з рукоятям / Csavarhúzó cserélhető feje / Set biti cu suport capat / Šroubovákové nástavce s držadlem / Skrutkovacie nástavce s upínadlom / Nastavki za izvijač z vpenjalom / Atsuktavo antgaliai su laikikliu / Skruvgrieža uzgaļu komplekts ar turētāju / Krivikeerajaotsakud koos käepidemega / Накрайники за отвёртка с держач / Nastavci za odvijač s hvataljkom / Nastavci za odvijač s drškom / Σετ με καταβιδώματα και προσαρμογέα / Puntas destornilladoras con mango / Set inserti con supporto / Ponteiros Chave de fenda com Suporte / Embouts de tournevis de précision avec manche / Schroevendraaiereinstukken met handvat

NEO
TOOLS

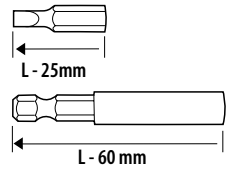

- ⊖ 4, 5, 6 mm
- ⊕ PH1, PH2
- ⊙ T15, T20



Ref. 06-101 12/120 EAN 5907558402339

TOPEX

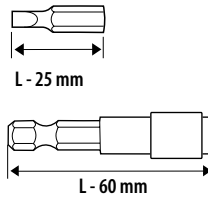

- ⊖ 4; 5; 6; 7 mm
- ⊕ PH1; PH2; PH3
- ⊕ PZ1; PZ2; PZ3
- ⊙ T10; T15; T20; T25
- ⊙ H3; H5; H6



Ref. 39D363 12/72 EAN 5902062393630

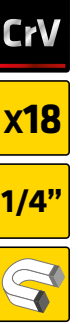

NEO
TOOLS

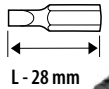

- ⊖ 1.0, 1.5, 2.0, 2.5, 3.0 mm
- ⊕ PH000, PH00, PH0, PH1
- ⊕ PZ00, PZ0, PZ1
- ⊙ T4, T5, T6, T7, T8, T9, T10, T15
- ⊙ H1.5, H2.0
- ⊙ P0.8, P1.2



Ref. 06-128 10/60 EAN 5907558444803

TOPEX



- ⊖ 5; 6 mm
- ⊕ PH1; PH2 x 2; PH3
- ⊕ PZ1; PZ2; PZ3
- ⊙ T15; T20; T25



Ref. 39D518 12/48 EAN 5902062395184



TOPEX

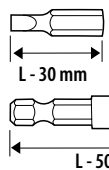

- ⊕ PH0; PH1 x 2; PH2 x 2; PH3

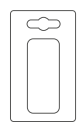

Ref. 39D350 12/96 EAN 5902062393500

TOPEX

- ⊖ 3; 4; 4.5; 5; 5.5; 6; 6.5; 7; 8 mm
- ⊕ PH0; PH1; PH2 x 5; PH3
- ⊕ PZ0; PZ1; PZ2 x 5; PZ3
- H1.5; H2; H2.5; H3; H4; H5; H5.5; H6; H8
- ⊙ H1/16"; H5/64"; H3/32"; H7/64"; H1/8"; H9/64"; H5/32"; H3/16; H7/32"; H1/4"
- ⊙ HT2; HT2.5; HT3; HT4; HT5; HT6
- ⊙ HT5/64"; H3/32"; H7/64"; H1/8"; H9/64"; H5/32"
- ⊙ T8; T10; T15; T20; T25; T27; T30; T40; T45
- ⊙ TT8; TT10; TT15; TT20; TT25; TT27; TT30; TT35; TT40
- ⊙ 4; 6; 8; 10
- ⊕ R0; R1; R2; R3
- ⊕ 6; 8; 10
- ⊙ M5; M6; M8
- ⊖ 1; 2; 3
- ⊖ 1; 2; 3; 4

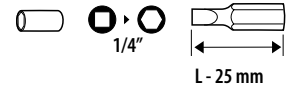

Ref. 39D359 0/10 EAN 5902062431011

TOPEX

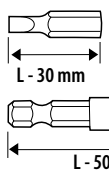

- ⊕ T10; T15; T20; T25; T30; T40



Ref. 39D351 12/96 EAN 5902062393517

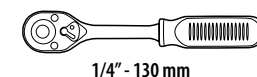
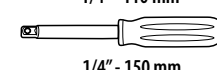
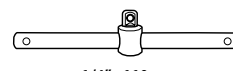
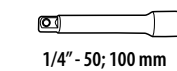

Końcówki wkrętakowe z uchwytem

Screwdriver bits with holder / Einsätze für Schraubendreher mit Aufnahme / Набор насадок с держателем / Наконечники викруткови, з рукоўям / Csavarhúzó cserélhető fejjű / Set biti cu suport capat / Šroubovákové nástavce s držadlem / Skrutkovacie nástavce s upínadlom / Nastavki za izvijač z vpenjalom / Atsuktuva antgaliai su laikikliu / Skrivgrieža uzgaļu komplekts ar turētāju / Kravikeeraajatsakud koos käepidemega / Накрайници за отвёртка с держач / Nastavci za odvijač s hvataljkom / Nastavci za odvijač s držkom / Σετ με καταβιδιώματα και προσαρμογέα / Puntas destornilladoras con mango / Set inserti con supporto / Ponteiros Chave de fenda com Suporte / Embouts de tournevis de précision avec manche / Schroevendraaierinstukken met handvat

TOP TOOLS

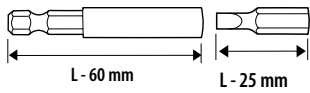

- ⊖ T8, T10, T15, T20, T25, T27, T30, T35, T40
- ⊕ 5/64", 3/32", 7/64", 1/8", 9/64", 5/32"
- ⊕ H2, H2.5, H3, H4, H5, H6
- ⊕ 4, 6, 8, 10
- ⊕ 1, 2, 3, 4
- ⊕ 6, 8, 10

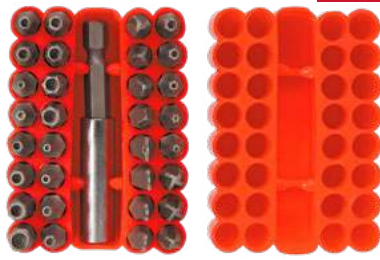

x33

Ref. 39D355 6/48 EAN 5902062053008

TOP TOOLS

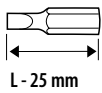

- ⊖ 5, 6, 7 mm
- ⊕ PH0, PH1, PH2, PH3
- ⊕ PZ0, PZ1, PZ2, PZ3
- ⊕ T10, T20, T30, T40

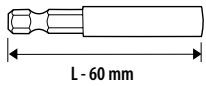

x16

Ref. 39D383 20/100 EAN 5902062393838

TOP TOOLS

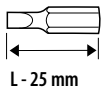

- ⊖ 4, 5, 6 mm
- ⊕ PH1, PH2, PH3
- ⊕ PZ1, PZ2

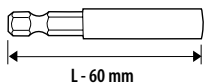

x7



Ref. 39D381 18/180 EAN 5902062050502

TOP TOOLS

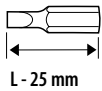

- ⊖ 5, 6 mm
- ⊕ PH1, PH2, PH3

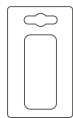

x6

Ref. 39D180 0/100 EAN 5902062051431

TOP TOOLS

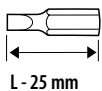

- ⊖ 4, 5, 6 mm
- ⊕ PH1, PH2, PH3
- ⊕ PZ1, PZ2

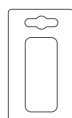

x9 **L/R**

Ref. 39D181 15/90 EAN 5902062051363

TOP TOOLS

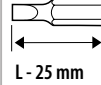

- ⊖ 3, 4, 5, 6 mm
- ⊕ PH1, PH2, PH3
- ⊕ H4
- ⊕ T10, T15, T20, T25

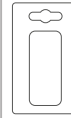

x13

Ref. 39D389 12/72 EAN 5902062002747

TOP TOOLS

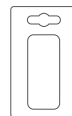
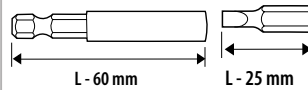

- ⊖ 3, 4, 4.5, 5, 5.5, 6, 7 mm
- ⊕ PH0, PH1, PH2, PH3
- ⊕ PZ0, PZ1, PZ2, PZ3
- ⊕ T10, T20, T25, T27, T30, T35, T40
- ⊕ H1.5, H2, H2.5, H3, H4, H5, H5.5, H6, H7, H8

CrV **x35**

Ref. 39D456 0/40 EAN 5902062394569

TOP TOOLS

- ⊖ 3, 4, 4.5, 5, 5.5, 6, 6.5, 7, 8
- ⊕ PH0, PH1, PH2, PH3
- ⊕ PZ0, PZ1, PZ2, PZ3
- ⊕ T8, T10, T15, T20, T25, T27, T30, T40, T45
- ⊕ TT8, TT10, TT15, TT20, TT25, TT27, TT30, TT40, TT45
- ⊕ H1.5, H2, H2.5, H3, H4, H5, H5.5, H6, H8
- ⊕ H1/16", H5/64", H3/32", H7/64", H1/8", H9/64", H5/32", H3/16", H7/32", H1/4"
- ⊕ HT2, HT2.5, HT3, HT4, HT5, HT6
- ⊕ HT5/64", HT3/32", HT7/64", HT1/8", HT9/64", HT5/32"

x100

CrV

1/4"

- ⊕ 1, 2, 3, 4
- ⊕ 6, 8, 10
- ⊕ 4, 6, 8, 10
- ⊕ 5, 6, 8
- ⊕ 0, 1, 2, 3
- ⊕ 1, 2, 3



Ref. 39D358 0/20 EAN 5902062431004

Końcówki wkrętakowe i nasadki z uchwytem

Driver bits and sockets with handle / Ein- und Aufsätzen für Schraubendreher mit Aufnahme / Набор сменных головок и насадок с держателем / Наконечники викрутковой и насадки с рукояткой / Bit és dugókulcskészlet / Capete de șurubelniță și tubulare cu mâner / Šroubovácové nástavce a nástavce s držadlem / Koncovky skrutkovača a nástavce s držakom / Nastavki za izvijače z vpenjalom / Sukimo antgaliai ir laikikliai su kotu / Skrūvgręzių nominaliūms galviņas uz gaļi ar turētāju / Krivikeeraajotsakud ja padrunid koos käepidemega / Накрайници и наставки за отвертки с держач / Nastavci za odvijač i kapice s hvataljkom / Nastavci za odvijač i nasadke s drškom / Σετ με ανταλλακτικές μύτες και καρδιάκια με αντάτορα / Puntas destornilladoras y vasos con mango / Set di inserti e bussole con cricchetto / Ponteiros chave de fenda e bocais com suporte / Embouts et douilles avec manche / Schroevendraaiereinstukken en doppen met handvat

TOPEX



- 3, 4, 5, 6, 7 mm
- PH1; PH2; PH3
- PZ1; PZ2; PZ3
- T10; T15; T20; T30
- H3; H4; H5; H6; H8



- 5; 6; 7; 8; 9; 10; 11; 12; 13 mm



Ref. 39D522 6/36 EAN 5902062395221

CrV
x34

TOPEX

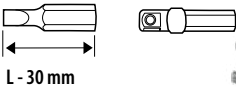

L - 30 mm

- 4; 5,5; 7 mm
- PH1; PH2 x 5; PH3
- T15; T20; T25
- H3; H4
- 1/4" - 10 mm



- 5; 6; 7; 8; 9; 10 mm
- 1/2"; 1/4"; 3/8"; 5/16"; 7/16"; 11/32"



Ref. 39D356 12/24 EAN 5902062393562

CrV x29 1/4"

TOPEX

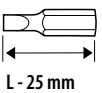
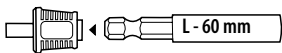

L - 25 mm

- 6; 7; 8; 9; 10; 11 mm
- 4; 7 mm
- PH1; PH2
- PZ1; PZ2; PZ3
- T10; T15; T20

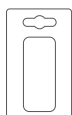

Ref. 39D361 12/72 EAN 5902062431103

x18 1/4"

TOPEX

CrV x38 x9 1/4" x27 25 [mm] 1/4"-5/16"



- 3, 4, 5, 6 mm
- PH0, PH1, PH2, PH3
- PZ0, PZ1, PZ2, PZ3
- T10, T15, T20, T25, T27, T30
- H2, H3, H4, H5, H6
- S0, S1, S2, S3
- 1/4": 4, 5, 6, 7, 8, 9, 10, 11, 12, mm



Ref. 39D344 6/24 EAN 5902062034199

TOPEX

CrV x68 x30 25 [mm] x24 28 [mm] x9 1/4"

- 3, 4, 5, 6 mm
- PH0, PH1, PH2, PH3
- PZ0, PZ1, PZ2, PZ3
- T10, T15, T20, T25, T27, T30
- H3, H4, H5, H6
- S0, S1, S2, S3

- 1, 1.5, 2, 2.5, 3, 3.5, 4 mm
- PH000, PH000, PH00, PH0, PH1
- PZ0, PZ1
- T4, T5, T6, T7, T8
- H0.7, H0.9, H1.3, H1.5, H2



- 1/4": 4, 5, 6, 7, 8, 9, 10, 11, 12, mm



Ref. 39D346 5/20 EAN 5902062034212

Końcówki wkrętakowe i nasadki z uchwytem

Driver bits and sockets with handle / Ein- und Aufsätzen für Schraubendreher mit Aufnahme / Набор сменных головок и насадок с держателем / Наконечники викруткои і насадки з ручкiям / Bit és dugókulcskészlet / Capete de șurubelniță și tubulare cu mâner / Šroubovácové nástavce a nástavce s držákem / Końcówki skrętkowaśa a nástavce s držákem / Nastavki za izvijače z vpenjalom / Sukimo antgatalai ir laikikliai su kotu / Skrūvgrīežu nomaināmās galviņas un uzgaļi ar turētāju / Krivikeeraajotsakud ja padrunid koos käepidemega / Накрайниці и наставки за отвертки с держач / Nastavci za odvijač i kapice s hvataljkom / Nastavci za odvijač i nasadke s drškom / Σετ με ανταλλακτικές μύτες και καρδάρια με αντίπορα / Puntas destornilladoras y vasos con mango / Set di inserti e bussolle con cricchetto / Ponteiros chave de fenda e bocais com suporte / Embouts et douilles avec manche / Schroevendraaierinstukken en doppen met handvat

TOPEX

CrV **x26** **1/4"**

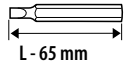

- ⊖ 3; 4; 5; 6; 7 mm
- ⊕ PH0; PH1 x 2; PH3
- ⊕ PZ1; PZ2; PZ3
- ⊙ T15; T20; T25

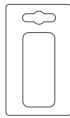

Ref. 39D352 6/24 EAN 5902062393524

TOPEX

CrV **x41** **1/4"**

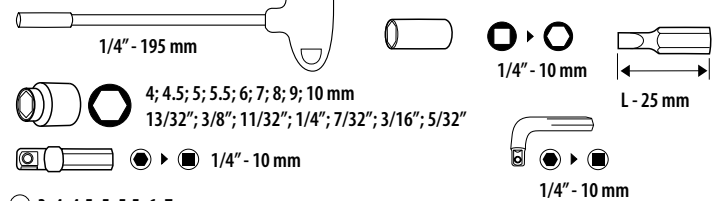

- 1/4" - 195 mm
- 4; 4.5; 5; 5.5; 6; 7; 8; 9; 10 mm
13/32"; 3/8"; 11/32"; 1/4"; 7/32"; 3/16"; 5/32"
- 1/4" - 10 mm
- 1/4" - 10 mm
- ⊖ 3; 4; 4.5; 5; 5.5; 6; 7 mm
- ⊕ PH1; PH2; PH3
- ⊕ PZ1; PZ2; PZ3
- ⊙ H3/32"; H1/8"; H5/32"; H3/16"
- ⊙ T20; T30

Ref. 39D369 0/12 EAN 5902062393692

TOP TOOLS

x22
CrV



- ⊖ 4, 5, 6 mm
 - ⊕ PH1, PH2, PH3
 - ⊕ PZ1, PZ2, PZ3
- 5, 6, 7, 8, 9, 10, 11, 12, 13 mm

Ref. 39D185 0/12 EAN 5902062053428

TOP TOOLS

x40
1/4"



- L - 30 mm
- ⊖ 5, 6, 7 mm
 - ⊕ PH1, PH2, PH3
 - ⊕ PZ1, PZ2
 - ⊙ T10, T15, T20, T25, T27, T30, T40
 - ⊙ 1/16, 5/64, 3/32, 1/8, 5/32, 3/16, 7/32, 1/4
- 6, 7, 8, 9, 10, 11, 12 mm
3/16, 1/4, 5/16, 11/32, 3/8, 7/16, 1/2"

Ref. 39D386 0/30 EAN 5902062051646

TOP TOOLS

x52



- L - 30 mm
- L - 50 mm
- ⊖ 6, 7, 8, 9, 10, 11, 12 mm
 - 3/16", 1/4", 5/16", 11/32", 3/8", 7/16", 1/2"

- ⊖ 3, 4, 5, 6 mm
- ⊕ PH0, PH1, PH2, PH3
- ⊕ PZ0, PZ1, PZ2, PZ3
- ⊙ T10, T15, T20, T25, T27, T30, T40
- ⊙ H1.5, H2, H2.5, H3, H4, H5, H5.5, H6

Ref. 39D357 0/20 EAN 5902062053107

TOP TOOLS

x44
CrV



25
MM
18
PCS

Ref. 39D200 6/24 EAN 5902062035769

TOP TOOLS

x21



- ⊖ 3, 4, 5, 6 mm
 - ⊕ PH1, PH2, PH3
 - ⊕ PZ1, PZ2, PZ3
 - ⊙ T10, T15, T20, T25, T27, T30, T40
- 4, 5, 6, 7, 8, 9, 10, 11, 12 mm

Ref. 39D385 30/60 EAN 5902062050526

Uchwyt do końcówek

Bit holder / Aufnahme für Spitzen / Зажим для наконечников / Тримач до наконечників / Csavarbehajtószer / Dispozitiv de prinderea capetelor / Skličadlo na nástavce / Upínadlo na nástavce / Vpenjalo za nastavke / Laikikkis antagialims / Uzgāju patrona / Otsakupadrin / Держач за накруйниці / Drška za nastavke / Hvata za nastavke / Προσαρμογέας μπιτών / Mandril de sujeción para puntas / Inesto per inserti con impugnatura / Suporte de ponteiros / Manche pour embouts / Houder voor eindstukken

NEO TOOLS



NEO TOOLS

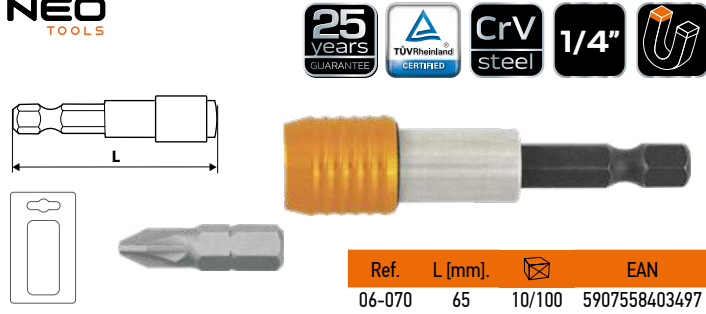

NEO TOOLS



T TOPEX

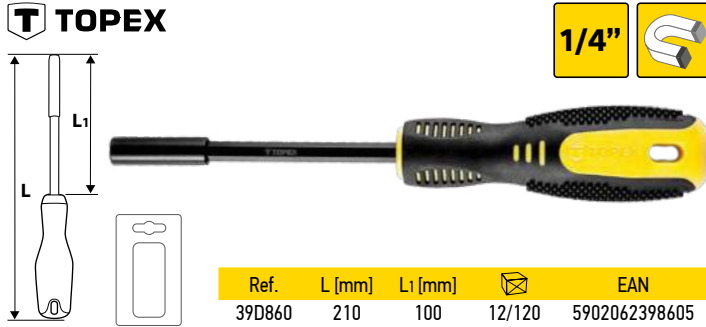

T TOPEX

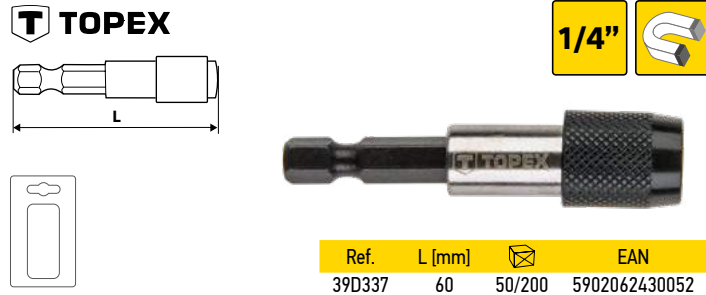

T TOPEX

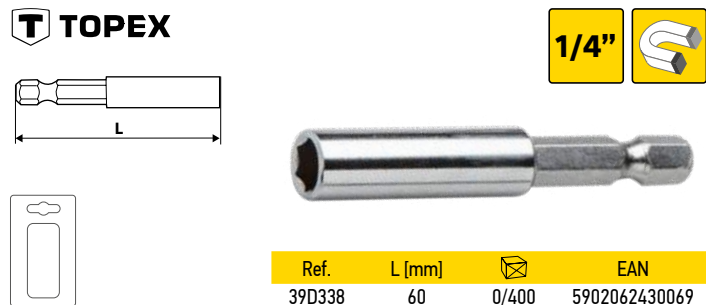

NEO TOOLS

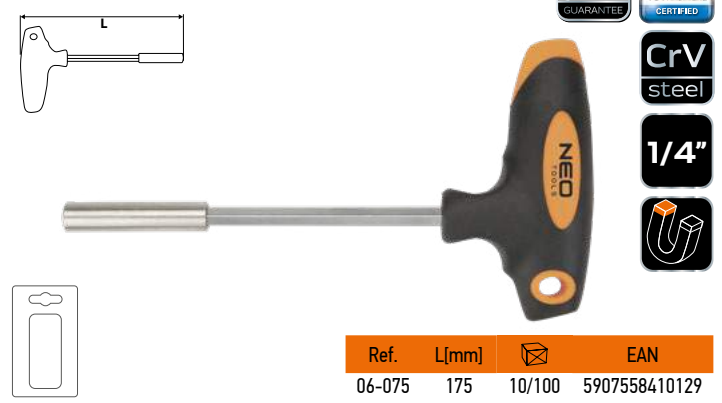

NEO TOOLS

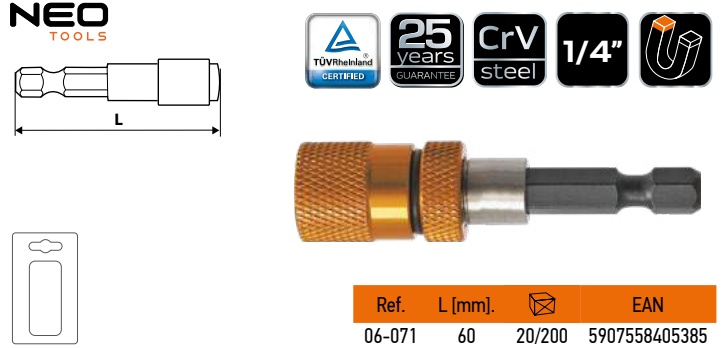

T TOPEX

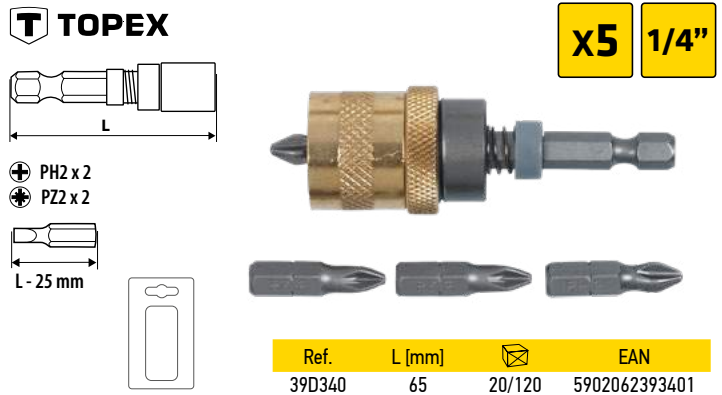

T TOPEX

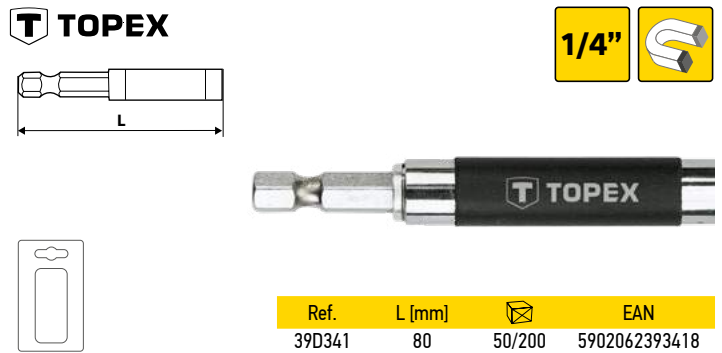

TOP TOOLS



Nasadki wkrętkowe

Socket bits / Schraubendrehereinsätze / Насадки / Насадки викруткови / Csavarbehajtó készlet / Tubulare cu antrenor bit / Šroubovákonné nástavce / Skrutkovacie nástavce / Nasadni ključci za izvijač / Sukimo antgaliai / Skrivgriēja uzgāļi / Krivikeerajapadrunid / Наставки за отвёртка / Карце одвијача / Nasadke za odvijać / Мутец / Vasos destornilladores / Bussole per trapano / Bocais de Chaves de fenda / Douilles de tournevis / Doppen voor schroevendraaiers

TOPEX

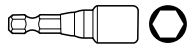

5; 6; 7; 8; 9; 10; 11; 13 mm



Ref.	⊕	EAN
39D387	25/100	5902062043498



Redukcje

Adapter set / Reduzierstücke / Переходники / Перехідники, набір / Adapterkészlet / Set adaptoare / Redukcije / Súprava redukcií / Garnitura adapterjev / Adapterji kompletas / Päreju komplekts / Adapterite komplekt / Адаптор / Produženi adapter / Adapter set / Συλλογή προσαρμοστών / Adaptador a cuadro / Adattatore / Reduções / Réductions / Reductiestukken

TOPEX

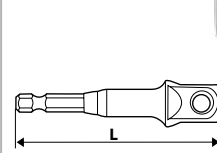

1/4" L - 65 mm
3/8" L - 65 mm
1/2" L - 75 mm



Ref.	⊕	EAN
38D151	24/144	5902062381514

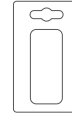

Końcówki wkrętkowe

Driver bits / Einsätze für Schraubendreher / Насадки / Наконечники викруткови / Csavarhúzó hegyek / Set biti / Šroubovákonné nástavce / Skrutkovacie nástavce / Nastavki za izvijače / Atsuktuvo antgaliai / Skrivgriēja uzgāļi / Krivikeerajatsakud / Накрайніци за отвёртка / Nastavci za odvijać / Nastavci za odvijać / Καταβιδόμετες / Puntas destornilladoras / Inserti / Ponteiros de chave de fenda / Embouts de tournevis / Schroevendraaierendstukken

NEO TOOLS

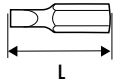

Ref.	⊕	L[mm]	⊗	EAN
06-011	PH2	25	12/120	5907558406351

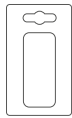

NEO TOOLS

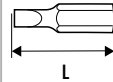

Ref.	⊕	L[mm]	N	⊗	EAN
06-020	PZ2	25	x20	50/150	5907558403015

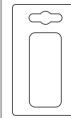

NEO TOOLS

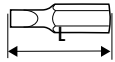

Ref.	⊕	L[mm]	N	⊗	EAN
06-036	PH2	25	x10	50/150	5907558403121
06-037	PH2	50	x5	50/200	5907558403138

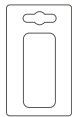

NEO TOOLS



Ref.	⊕	⊗	EAN
06-040	PH2	24/192	5907558410099

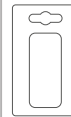

TOPEX

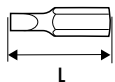

Ref.	⊕	L[mm]	⊗	EAN
39D314	PH2	25	10/300	5902062432100

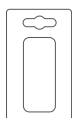

TOP TOOLS

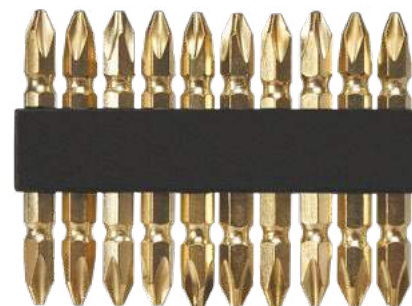
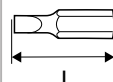

Ref.	⊕	L[mm]	⊗	EAN
39D382	PH2	60	0/100	5902062050519

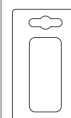

Haki

Hooks / Hacken / Крюки / Ганки / Horgok / Cârlige / Háký / Skoby / Kľjuke / Kabliai / Āķi / Haagid / Кюки / Кюке / Кюке / Γάντζοι / Ganchos / Ganci / Anzós / Crochets / Haken

NEO
TOOLS



25
years
GUARANTEE

TÜVRheinland
CERTIFIED

CrV
steel

x4

Ref. 04-230 6/48 EAN 5907558410075

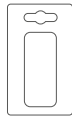

TOP TOOLS



x4

Ref. 39D173 L [mm] 150 12/96 EAN 5902062002723

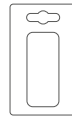

Wkręтак ударowy

Impact screwdriver / Schlag-Schraubendreher / Отвертка ударная / Викрутка ударна / Ütvecsavarozó / Surubelnjā su percutor / Šroubovák rázový / Rázový skrutkovač / Udarni izvijač / Smūginis suktuvas / Trieciēna skrūvgriezis / Löökkruvikeeraja / Ударна отвертка / Odvijač s udarom / Udarni odvijač / Καταβίβι κρούσης / Destornillador de impacto / Sacciavite a percussione / Chave de fenda de impacto / Tournevis à chocs / Slagschroevendraaier

NEO
TOOLS

25
years
GUARANTEE

TÜVRheinland
CERTIFIED

S2
steel

CrV
steel

x11



5, 6, 8, 10, 12, 14 mm
PH1, PH2, PH3

1/2" 5/16"

Ref. 04-250 m[kg] 1,2 0/12 EAN 5907558410082

TOPEX

CrV x7



1/2" - 5/16"
7; 8 mm L - 35 mm
PH2; PH3



Ref. 39D556 0/20 EAN 5902062395566

Szpikulec

Point chisel / Spicknadel / Наконечник / Шило / Ár / Tijā ascuțită / Hrot / Šidlo / Igla za pretikanje / Yla / Caurumsitis / Naaskel / Шило / Šiljak / Probačač, šilo / Műtű / Púa / Punteruolo / Ponta / Pointe / Puntbeitel

NEO
TOOLS

CrV
steel



TRIANGLE
shape

oil
resistant

6x100
mm



Ref. 04-037 12/120 EAN 5907558435917

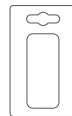

Wkręтак акумулаторowy

Cordless Screwdriver / Akku-Schraubendreher / Отвертка акумулаторная / Шрубоверт акумулаторний / Akkumulátoros csavarozó / Surubelnjā su acumulator / Akkumulátorový šroubovák / Akkumulátorový skrutkovač / Akumulatorski vijačnik / Akumulatorinis suktuvas / Akumulatora skrūvgriezis / Akukurvikeeraja / Akumulatorna отвертка / Akumulatorski odvijač / Akumulatorski odvijač / Εναρφορτιζόμενο καταβίβι / Destornillador a batería / Avvitatore a batteria / Chave de fenda de bateria / Tournevis à batteries / Accu schroevendraaier

NEO
TOOLS



CrV steel 1/4" 3.6V Li-Ion
left-right 280 min⁻¹ 1/4"
max 2.1 Nm 800 mAh 1 h



Ref. 04-200 0/16 EAN 5907558439380

Wkrętak płaski 1000V

Screwdriver slotted / Flachsraubendreher / Отвертка плоская / Відкрутка плоска / Csavarhúzó / Šurubelnitá platá / Šroubovák plochý / Skrutkovač plochý / Ploščati izvijač / Ploščias atsuktuvus / Skrūvgriezis plakans / Lamepa-kruvikeeraja / Отвертка / Одвијач / Одвијач / Καταβίδι ευκονής / Destornillador plano / Giravite piatto 1000V / Chave de fenda plana / Tournevis à fourche / Vlakke schroevendraaier

NEO
TOOLS



Ref.	⌀ [mm]	L [mm]	L ₁ [mm]	⊠	EAN
04-051	2,5	150	75	12/600	5907558401998
04-052	3,0	175	100	12/240	5907558402001
04-053	4,0	205	100	12/240	5907558402018
04-054	5,5	230	125	12/144	5907558402025
04-055	6,5	270	150	12/144	5907558402032

NEO
TOOLS



Ref.	⌀ [mm]	L [mm]	L ₁ [mm]	⊠	EAN
04-130	0,4	175	75	12/120	5907558433227
04-131	0,6	195	100	12/120	5907558433234
04-132	0,8	198	100	12/120	5907558433241
04-133	1,0	230	125	12/120	5907558433258

T TOPEX



Ref.	⌀ [mm]	L [mm]	L ₁ [mm]	⊠	EAN
39D470	2,5	175	70	80/320	5902062394705
39D471	3,0	205	100	60/240	5902062394712
39D472	4,0	210	100	50/200	5902062394729
39D473	5,5	245	125	30/120	5902062394736
39D474	6,5	270	150	25/100	5902062394743

Wkrętak krzyżowy PH 1000V

Screwdriver Phillips / Kreuzschraubendreher / Отвертка крестовая / Відкрутка крестовидна / Csavarhúzó philips / Šurubelnitá tip „Phillips“ / Šroubovák křížový / Skrutkovač PH / Křížni izvijač / Kryžminis atsuktuvus Phillips / Skrūvgriezis krusta PH / Ristpeakruvikeeraja / Отвертка / Одвијач / Одвијач / Καταβίδι σταυρωτό τύπου philips / Destornillador phillips / Giravite Phillips / Chave de fenda de cruzeta / Tournevis en croix / Kriusschroevendraaier



Ref.	⊕	L [mm]	L ₁ [mm]	⊠	EAN
04-071	PH0	135	60	12/600	5907558402070
04-072	PH1	190	80	12/240	5907558402087
04-073	PH2	215	100	12/144	5907558402094

NEO
TOOLS



Ref.	⊕	L [mm]	L ₁ [mm]	⊠	EAN
04-137	PH0	160	60	12/120	5907558433296
04-138	PH1	185	80	12/120	5907558433302
04-139	PH2	210	100	12/120	5907558433319
04-140	PH2	285	175	12/120	5907558433326

T TOPEX



Ref.	⊕	L [mm]	L ₁ [mm]	⊠	EAN
39D475	PH0	270	60	80/320	5902062394750
39D476	PH1	195	80	40/160	5902062394767
39D477	PH2	220	100	30/120	5902062394774

Wkrętak krzyżowy PZ 1000V

Screwdriver Pozidriv / Kreuzschraubendreher / Отвертка крестовая / Відкрутка крестовидна / Csavarhúzó pozidriv / Šurubelnitá tip „Pozidriv“ / Šroubovák křížový / Skrutkovač PZ / Křížni izvijač / Kryžminis atsuktuvus Phillips / Skrūvgriezis krusta PZ / Ristpeakruvikeeraja Pozidriv / Отвертка / Одвијач / Одвијач / Καταβίδι τύπου pozidriv / Destornillador phillips / Giravite Pozzi 1000V / Chave de fenda de cruzeta / Tournevis en croix / Kriusschroevendraaier

NEO
TOOLS



Ref.	⊕	L [mm]	L ₁ [mm]	⊠	EAN
04-062	PZ1	190	80	12/240	5907558402056
04-063	PZ2	217	100	12/144	5907558402063

NEO
TOOLS



Ref.	⊕	L [mm]	L ₁ [mm]	⊠	EAN
04-136	PZ2	210	100	12/120	5907558433289

T TOPEX



Ref.	⊕	L [mm]	L ₁ [mm]	⊠	EAN
39D479	PZ1	195	80	40/160	5902062394798
39D480	PZ2	220	100	30/120	5902062394804

Wkrętak krzyżowy PZ/SL & PH/SL 1000V

Screwdriver / Kreuzschraubendreher / Отвертка крестовая / Відкривка хрестовицна / Csavarhúzó / Šurubelníča / Šroubovák křížový / Skrutkovač / Křížni izvijač / Kryžminis atsuktuvas / Skrūvgriezis krusta / Ristpeakruvikeeraja / Отвертка / Odvijáč / Odvijac / Καταβίδι σταυρωτό τύπου / Destornillador phillips / Giravite / Chave de fenda de cruzeta / Tournevis en croix / Kriusschroevendraaier

NEO
TOOLS



Ref.	⊖ ⊕	L[mm]	L ₁ [mm]	📦	EAN
04-221	SL/PZ2	220	100	12/144	5907558432398
04-222	SL/PH2	220	100	12/144	5907558432404

Wkrętaki 1000V

Screwdriver set / Schraubendreher / Отвертки / Відкривки, набір / Csavarhúzókészlet / Set šurubelníče / Šroubováky / Súprava skrutkovačov+bity / Komplet izvijačev / Atsuktuvų komplektas / Skrūvgriežu komplekts / Kruvikeerajate komplekt / Отвертки компл. / Odvijáč / Odvijac set / Συλλογή καταβιδιών / Destornilladores / Set giraviti 1000V / Chaves de fenda / Tournevis / Schroevendraaiers

NEO
TOOLS

- ⊖ 2.5x75 mm, 4x100 mm, 6.5x150 mm
- ⊕ PH1x80 mm, PH2x100 mm



Ref.	📦	EAN
04-220	6/36	5907558402278

NEO
TOOLS



- ⊖ 0.6, 0.8, 1.0, 1.2, 1.6 mm
- ⊕ PH0, PH1, PH2, PH3

Ref.	📦	EAN
04-142	0/12	5907558433340

NEO
TOOLS

- ⊖ 3, 4, 5.5, 6.5, 8 mm
- ⊕ PH0, PH1, PH2, PH3



Ref.	📦	EAN
04-143	0/12	5907558433357

TOPEX

- ⊖ 3, 5.5, 6.5 mm
- ⊕ PH1, PH2

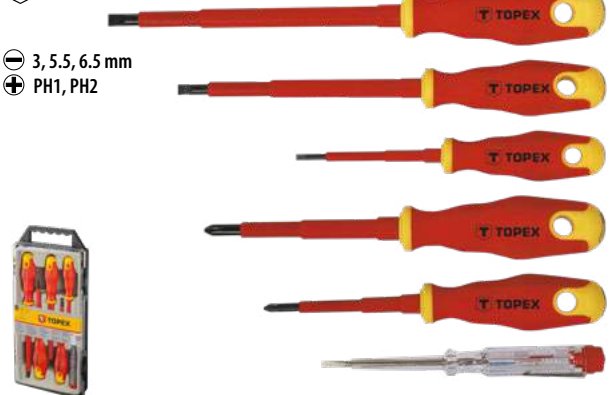

Ref.	📦	EAN
39D673	6/24	5902062396730

TOPEX

- ⊖ 3, 4, 5.5 mm
- ⊕ PH1, PH2



Ref.	📦	EAN
39D150	0/10	5902062391506

TOPEX

- ⊖ 3, 4, 5.5 mm
- ⊕ PH1, PH2

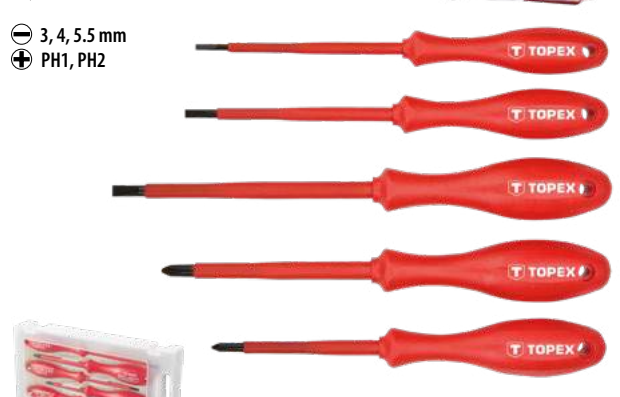

Ref.	📦	EAN
39D155	0/10	5902062051776

Wkrętaki 1000V

Screwdriver set / Schraubendreher / Отвертки / Відкрутки, набір / Csavarhúzókészlet / Set şurubelişte / Šroubováky / Súprava skrutkovačov+bity / Komplet izvijačev / Atsuktuvų komplektas / Skrivgriežu komplekts / Krivikeerajate komplekt / Отвертки компл. / Odvijáč / Odvijac set / Συλλογή καταβιδιών / Destornilladores / Set giraviti 1000V / Chaves de fenda / Tournevis / Schroevendraaiers

TOPEX

⊖ 4, 5,5, 6,5 mm
⊕ PH0, PH1, PH2, PH3

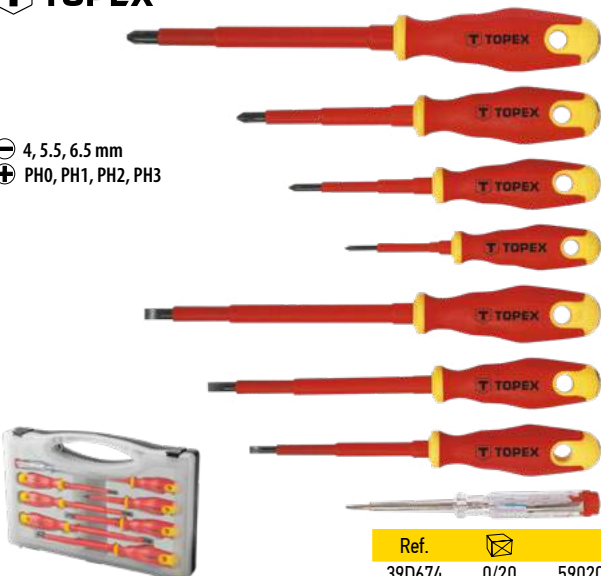

CrMo

1000V

X8

Ref.	☒	EAN
39D674	0/20	5902062396747

Końcówki wkrętakowe z uchwytem 1000V

Screwdriver bits with holder / Einsätze für Schraubendreher mit Aufnahme / Набор насадок с держателем / Наконечники викруткові, з ручієм / Csavarhúzó cserélhető fejű / Set biti cu suport carat / Šroubovákové nástavce s držadlem / Skrutkovicave nástavce s upínadlom / Nastavki za izvijač z vpenjalom / Atsuktuvo antgaliai su laikikliu / Skrivgrieža uzgāļu komplekts ar turētāju / Krivikeerajatsakud koos käepidemega / Накрайници за отвертка с държач / Nastavci za odvijac s hvataljkom / Nastavci za odvijac s drškom / Σετ με καταβιδόμπετες και προσαρμογέα / Puntas destornilladoras con mango / Set inserti con supporto / Ponteiros Chave de fenda com Suporte / Embouts de tournevis de précision avec manche / Schroevendraaiereinstukken met handvat

NEO TOOLS



1000V

S2 steel

54-61 HRC

x12

Ref.	☒	EAN
01-308	0/20	5907558435597

NEO TOOLS



1000V

S2 steel

54-61 HRC

x50

Ref.	☒	EAN
01-309	0/10	5907558435603

Nasadka sześciokątna 1000V

Hexagonal socket / Sechskanteinsatz / Головка сменная шестигранная / Насадка шестигранна / Dugókulcs / Cheie tubulara hexagonala / Šestihranný nástavec / Šesthranný nástavec / Šestkotni natični nastavek / Šešiakampis antgalis / Sešstūra nomaināmā galva / Kuuskantpadrun / Шестозъелна наставка / Šesterokutna kapica / Šestougaona nasadka / Καρούάκι εξήγωνο / Vaso para destornillador hexagonal / Bussola esagonale / Bocal hexagonal / Douille à 6 pans / Zeskant dop

NEO TOOLS



25 years GUARANTEE

TUV Rheinland CERTIFIED

1000V

CrV steel

1/2"



Ref.	W[mm]	☒	EAN
01-181	10	12/108	5907558432893
01-182	11	12/108	5907558432909
01-183	12	12/108	5907558432916
01-184	13	12/108	5907558432923
01-185	14	12/108	5907558432930
01-186	16	12/108	5907558432947
01-187	17	12/108	5907558432954
01-188	18	12/108	5907558432961
01-189	19	12/108	5907558432978
01-190	21	11/110	5907558432985
01-191	22	11/110	5907558432992
01-192	24	11/110	5907558433005
01-193	27	15/105	5907558433012
01-194	30	10/90	5907558433029
01-195	32	10/90	5907558433036

Grzechotka 1000V

Ratchet handle / Ratsche / Трещотка / Держак з тріскотною / Racsnikulcs / Miner de hurluitoare / Řehtačka / Račňa prepínacia / Raglja / Terkšle / Reversa atslėga / Pörkratta pide / Трещотка / Račva za nasadni ključ / Racva za gedoru / Κατσάνα / Llave de carraca / Cricchetto / Catraca de furar / Clé à cliquet / Rattel

NEO TOOLS

25 years GUARANTEE

TUV Rheinland CERTIFIED

CrV steel

1000V

1/2"

250 mm



Ref.	☒	EAN
01-180	4/28	5907558432817

Klucze sześciokątne 1000V

Hex key / Sechskantschlüssel / Ключи шестигранные / Ключ шестигранный / Imbuskulcs készlet / Set chei cu șase laturi / Šestihranný klíč / Súprava imbus klúčov (dlhé) / Garnitura imbus ključev / Šešiakampij raktu komplektas / Seškanšū atslėgu komplekts / Kuuskant-mutrivõtmete komplekt / Лумбусу компл. / Ključ imbus set / Ključ imbus set / Συλλογή εξήγωνικών κλειδιών / Llaves Allen / Chiavi esagonali / Chaves hexagonais / Clefs à 6 pans / Zeskantsleutels

NEO TOOLS

25 years GUARANTEE

TUV Rheinland CERTIFIED

CrV steel

1000V



Ref.	● [mm]	☒	EAN
01-171	3	8/72	5907558432824
01-172	4	8/72	5907558432831
01-173	5	6/72	5907558432848
01-174	6	6/54	5907558432855
01-175	8	8/48	5907558432862
01-176	10	8/48	5907558432879
01-177	12	6/36	5907558432886

Klucz płaski jednostronny 1000V

Open single end spanner / Maulschlüssel einseitig / Ключ рожковый односторонний / Ключ рожковый / Villáskulcs / Cheie piulită unilaterală cu cavitatea deschisă / Plochý klíč jednostranný / Klíč vidlicový jednostranný / Viličasti ključ / Ploščias vienpusis rakts / Ragatslēga / Ūhe avatud otsaga vīti / Ключ Гаечен / Kjuč viljuškasti / Kjuč viljuškasti / Movó γερμανικό κλειδί / Llave fija de una boca / Chiave a forchetta / Chave plana / Clef à fourche simple / Eenzijdig vlakke sleutel

NEO
TOOLS



Ref.	● [mm]	☒	EAN
01-110	6	9/108	5907558432411
01-111	7	9/108	5907558432428
01-112	8	9/108	5907558432435
01-113	9	9/108	5907558432442
01-114	10	9/108	5907558432459
01-115	11	9/108	5907558432466
01-116	12	9/108	5907558432473
01-117	13	9/108	5907558432480
01-118	14	8/72	5907558432497
01-119	15	8/72	5907558432503
01-120	16	8/72	5907558432510
01-121	17	8/72	5907558432527
01-122	18	8/72	5907558432534
01-123	19	8/72	5907558432541
01-124	21	6/54	5907558432558
01-125	22	6/54	5907558432565
01-126	24	6/54	5907558432572
01-127	27	6/36	5907558432589
01-128	30	6/36	5907558432596
01-129	32	6/36	5907558432602

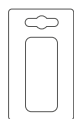

Klucze nasadowe 1000V

Socket wrenches / Steckschlüssel / Набор сменных головок / Ключи торцевые / Dugókulcskészlet / Trusa tubulare / Nástrčné kľúče / Nástrčné klúče / Nasadni ključji / Veržlerakčio antgaliai / Nomaināmo galvu komplekts / Радгунвџмед / Сменными накрайници за ключове / Nasadni ključevni / Ključevni natičaki / Σετ με καρδιάκια / Llaves de vaso / Set di bussolle SuperLock / Chaves tubulares / Clefs à douilles / Dopsleutels

NEO
TOOLS



1/2" - 10, 11, 12, 13, 14, 16, 17, 18, 19, 21, 22 mm

1/2" - 125, 200 mm

1/2" - 115 mm - H4, H5, H6, H8

1/2" - 200 mm

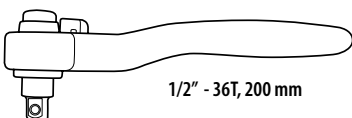

1/2" - 36T, 200 mm

Ref.	☒	EAN
01-306	0/3	5907558435573

Konektory

Electric connectors set / Steckverbinder-Set / Коннекторы набор / Коннектори, набір / Kábel-sarukészlet / Conectori set / Konektory súprava / Konektory / Komplet elektrických príkľučkov / Elektro jungtçi rinkiny / Elektrisko savienotāju komplekts / Elektristikutte komplekt / Комплект электрически съединители / Komplet elektrických konektorů / Комплект электрических коннекторов / Σετ ηλεκτρικών συνδετήρων / Juego de conectores eléctricos / Set di connettori / Conjunto de conectores eléctricos / Jeu de connecteurs électriques / Elektrische connectoren set

NEO
TOOLS

x420

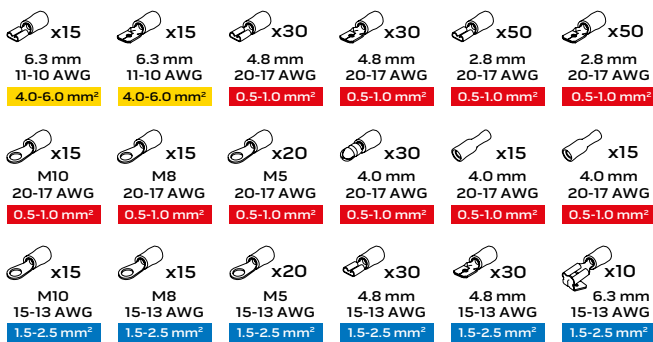

Ref.	☒	EAN
01-535	0/36	5907558439366

NEO
TOOLS



1/2" - 10, 12, 13, 14, 17, 19 mm

1/2" - 125 mm

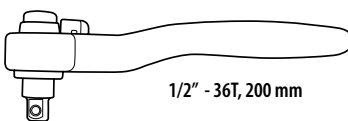

1/2" - 36T, 200 mm

Ref.	☒	EAN
01-307	0/5	5907558435580

Skrzynia serwisowa elektryka 52 szt.

Electrician's tool box 52 pcs / Servicekasten für Elektriker 52-teilig / Инструментальный ящик электрика 52 шт. / Инструментальный ящик электрика 52 шт. / Villanyzerelő koffer, 52 db / Cutie scule electrician 52 piese / Elektrikářský servisní box 52 ks / Elektrikářska skrinka s náradím 52 ks / Servisni kovček elektrikařa 52 kos. / Irankių dėžė elektrikui 52 vnt. / Elektriķa instrumentu kaste 52 gab. / Elektriķu tōiristakast 52 tk / Куфар с инструменти за електротехник 52 бр. / Servisni ormar za električare 52 kom. / Servisna kutija električara 52 kom. / Βαλίτσα εργαλείων ηλεκτρολόγου 52 τμχ / Caja de servicio de eléctrico 52 uds. / Cassetta portautensili per elettricista 52 pz. / Kit de 52 ferramentas de electricista em caixa / Caisse à outil électricien / Gereedschapskoffer van elektricien 52 st.

NEO
TOOLS

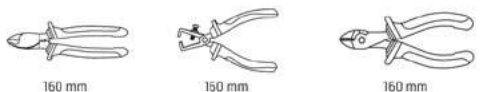

160 mm

150 mm

160 mm

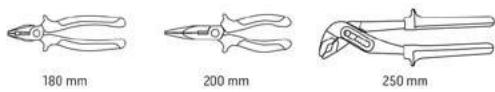

180 mm

200 mm

250 mm

1/2" - 10 / 11 / 12 / 13 / 14 / 16 / 17 / 18 / 19 / 21 / 22 / 24 / 27 mm

1/2", 115 mm - H4 / H5 / H6 / H8

1/2" - 125 / 250 mm

195mm

PH0x60, PH1x80, PH2x100, PH3x150
2.5x75mm, 3x100mm, 4x100mm, 5.5x125mm, 6.5x150mm

8, 10, 11, 12, 13, 14, 15, 16, 17, 18, 19, 22, 24 mm

230 mm, Ra 30 mm



Ref.	Icon	EAN
01-311	0/1	5907558439991

Walizka elektryka

Electrician's suitcase / Elektriker-Koffer / Чемодан электрика / Βαλίτσα ηλεκτρικα / Villanyzerelő koffer / Valiza electricianului / Kufr elektrikaře / Elektrikářský kufrík / Kovček za električarje / Lagaminas elektrikiui / Elektriķa instrumentu koferis / Elektriķu kohver / Куфарче на електротехник / Kovček za električare / Kofar električara / Βαλίτσα εργαλείων ηλεκτρολόγου / Maletin de eléctrico / Valigetta da elettricista / Mala de eletricista / Malette à outils pour électricien / Gereedschapstas elektricien

NEO
TOOLS



1/2" - 15-16-17-19-20-21-22-24-27-30-32 mm
1/4" - 4-4.5-5-5.5-6-7-8-9-10-11-12-13-14 mm

1/2" - E20-E22-E24
3/8" - E10-E11-E12-E14-E16-E18
1/4" - E4-E5-E6-E7-E8

1/2" - T2T
1/4" - T2T

1/2" - 125, 250 mm

1/4" - 50, 100 mm

1/2" - 16, 21 mm

1/4" - 115 mm

1/4" - 150 mm

1000V
SL 5.5x125, SL 3x100mm
PH0x60mm, PH1x80mm
PH2x100mm

250 V CE

160 mm

1000V, 160 mm

1000V, 160 mm

180 mm

0.34-6 mm²

0.25-6 mm²

0.5-6 mm²

0.5-16 mm²



Ref.	Icon	EAN
01-310	0/2	5907558431957

Próbnik instalacji elektrycznej

Voltage tester / Elektroprüfgerät / Отвертка-индикатор / Відкритка-індикатор напруги / Fázisceruza / Aparat de măsurat presiunea / Zkoušečka elektrické instalace / Skúšačka elektro / Preizkuševalec napetosti / El. itampos testeris / Testeris elektroinstalācijai / Voltmeeter / Фазомер / Ispitivač / Glinerica / Δοκιμαστικό καταβίβι ηλεκτρικής εγκατάστασης / Destornillador buscapolos / Voltmetro / Testador de instalação elétrica / Testeur d'installation électrique / Tester van de elektrishe installatie

TOPEX

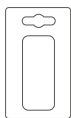

Ref.	U [V]	L [mm]	⊠	EAN
39D067	3-500	175	0/20	5901182000022

TOPEX

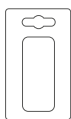

Ref.	U [V]	L [mm]	⊠	EAN
39D066	3-500	155	0/25	5902062051240

TOPEX

250V

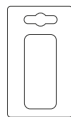

Ref.	U [V]	L [mm]	⊠	EAN
39D058	125-250	140	30/240	5902062390585

TOPEX

250V

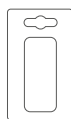

Ref.	U [V]	L [mm]	⊠	EAN
39D055	220-250	140	12/600	5902062051592

TOPEX

250V

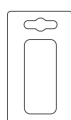

Ref.	U [V]	L [mm]	⊠	EAN
39D054	100-250	190	20/500	5902062504982



MOTORYZACYJNE AUTOMOTIVE TOOLS

АВТОМАСТЕРСКОЕ

NEO TOOLS

! Podnośnik przeznaczony jest wyłącznie do podnoszenia, przed podniesieniem pojazdu należy użyć stałej torbi. Podnośnik ustawić na równym i twardym podłożu.

Before use, repair jack stands should be used. Do not overload. Bottle jack should be placed on flat and firm surface.

1.25 T

12.5 kg

11-730

CE m-c rok

NEO TOOLS

Zestaw blokad rozrządu

Timing tool set / Nockenwellen-Arretierwerkzeugsatz / Набор фиксаторов распределителя для установки фаз ГРМ / Набор стопорів для розподільвальних валів / Vezérműtengely blokkoló készlet / Set de blocarea distribuției / Sada blokovací pro opravu rozvodů / Súprava blokad rozvodov / Set blokad gredi / Paskirstymo velenėlių fiksavimo komplektas / Sadales mehānismu fiksatoru komplekts / Jaotuse blokeerimise komplekt / Комплект блокировки на газораспределителе / Set alata za blokiranje radilice / Pribor za blokadu razvođenja / Σετ συγκράτησης κινδωκοφόρων αξόνων / Kit de bloqueo de la correa de distribución / Attrezzi di blocco dell'albero a camme / Conjunto de bloqueios de engranagem de distribuição / Ensemble de verrouillage de distribution / Set van distributievevergrendeling

NEO
TOOLS



TDI
VAG

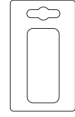

1.2D TDI PD: ANY, AYZ
1.4D TDI PD: AMF, ATL, BHC
1.9D TDI PD: AJM, ANU, ARL, ASZ, ATD, ATJ, AUY,
AVB, AVF, AWX, AXR, BSW, BTB, BVK

Ref.	📦	EAN
11-300	10/40	5907558436051

NEO
TOOLS



TDI
VAG

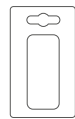

Audi: A1 (10-15), A2 (00-06), A3 (01-13), A4/Allroad (01-16), A5 (08-15), A6 (11-14), TT (08-14), Q3 (11-15), Q5 (08-15), A6 (10-14)
Dodge: Caliber (06-11)
Ford: Galaxy (02-06)
Mitsubishi: Grandis (05-10), Lancer (05-10), Outlander (07-10)
Seat: Alhambra (00-15), Altea/Altea XL (04-15), Cordoba (02-09), Ibiza (02-15), Leon (00-13), Toledo (04-11)
Skoda: Fabia (00-14), Fabia II (07-15), Octavia (00-10), Octavia II (04-15), Praktik (10-15), Rapid (11-15), Roomster (07-15), Superb (02-08), Superb II (08-15), Yeti (09-14)
VW: Amarok (10-16), Beetle (02-15), Bora (02-08), Caddy/Maxi (03-15), EOS (06-15), Fox (05-11), Golf (02-15), Golf Plus (05-14), Jetta (05-15), Lupo (02-05), Passat/CC (02-15), Polo (99-14), Scirocco (08-14), Sharan (02-15), Tiguan (07-15), Touran (03-15), Transporter (03-18)



Kody silników / Engine codes / Коды двигателя:

1.2D TDI CR: CFWA
1.4D TDI PD: AMF, BAY, BMS, BNM, BNV, BWB
1.6D TDI CR: CAYA, CAYB, CAYC, CAYD, CAYE, CLNA
1.9D TDI PD: AJM, ANU, ARL, ASZ, ATD, AUY, AVB, AVF, AVQ, AWX, AXB, AXC, AXR, BJB, BKC, BLS, BLT, BMT, BPZ, BRM, BRR, BRS, BRU, BSU, BSV, BSW, BTB, BVK, BXE, BXF, BXJ
2.0D TDI CR/TDI PD: AZV, BDJ, BDK, BEW, BGW, BHW, BKD, BKP, BKQ, BLB, BMA, BMM, BNM, BNP, BMR, BNA, BPW, BRA, BRC, BRD, BRE, BRF, BRT, BSS, BST, BSY, BUY, BUZ, BVA, BVE, BVF, BVG, BVH, BWC, BWV, CAAA, CAAB, CAAC, CAAD, CAAE, CAGA, CAGB, CAGC, CAHA, CAHB, CBAA, CBAB, CBAC, CBBA, CBBB, CBDA, CBDB, CBDC, CBEA, CCHA, CCHB, CDBA, CDCA, CEGA, CFCA, CFFA, CFFB, CFFD, CFFE, CFBG, CFCG, CFHA, CFHB, CFHC, CFHD, CFHE, CFJA, CGLA, CGLB, CGLC, CGLD, CJAA, CJCA, CJCB, CJCC, CLCA, CLCB, CLJA, CLLA, CNEA, ECD, ECD/BSY, ECD/BYL, ECE/BWD

OEM:

Dodge: 9882, 9883
Ford: 310-085/23-059, 303-1054
Mitsubishi: MB995206, MB995208, MB995209
VAG: T10100, T10050, 3359/T20102, T10115, T10060A/T40098, T20167

Ref.	📦	EAN
11-301	10/40	5907558436068

NEO
TOOLS



TDI
VAG



AUDI: A1, A3, A4 (B8), A5, A6 (C6, C7), TT, Q3, Q5
VW: Golf V-VI, Passat B6, B7, Polo, Jetta V-VI, Scirocco III, Beetle II, Caddy, Touran, Sharan II, T5
SKODA: Fabia, Roomster, Practice, Octavia II, Superb II, Yeti
SEAT: Ibiza, Leon, Exeo, Altea, Alhambra II



Kody silników / Engine codes / Коды двигателя:

1.6 TDI CR (> 2009): CAYB, CAYC
2.0 TDI CR (> 2007): CAAA, CAAB, CAAC, CAAB, CBAB, CBBA, CBAA, CFFB, CAGA, CAHA, CAGB, CAHB, CAGC, CCHA, CAVA, CBDA, CBDD, CBAC, CBDC

OEM: T20102 | U40074 | 3359 | T10050 | T10100 | T10264 | T10265 | T40098 | T10051 | T10052 | T10255

Ref.	📦	EAN
11-302	1/5	5907558436075

NEO
TOOLS



TDI
VAG



Audi: A4 2.7 TDI (05-09); A4 Quattro 2.0 TDI (05-06), Q7 3.0 TDI (06-09)
Volkswagen: Touareg 3.0 V6 TDI (08-); Phaeton 3.0 V6 TDI (06-); Diesel 2.7 TDI, 2.0 TDI 3.0 TDI



Kody silników / Engine codes / Коды двигателя
2.7 TDI V6: BBP, BSG, CAMA, CAMB, CANA, CANC, CAND, CGKA, CGKB
3.0 TDI V6: ASB, BKN, BKS, BMK, BMZ, BNG, BUG, BUN, CAPA, CARA, CARB, CASA, CASB, CASC, CATA, CCMA, CCWA, CCWB, CDYA, CDYB, CDYC, CEXA, 4.0 TDI V8: ASE
OEM: T40062 | T40061 | T40049 | 3359 | T40058 | T40060 | 3242

Ref.	📦	EAN
11-303	1/5	5907558436082

NEO
TOOLS



VAG



Benzyzna / Gasoline / Бензин: 1,2 6V/12V / 1,4 16V / 1,6 16V / 1,4FSI / 1,6FSI

Diesel: 1,2TDi / 1,4TDi / 1,9TDi / 2,0TDi / 2,5 V6 TDi / 3,3 V8 TDi / 2,0TDi (PD oraz CR) / 1,6 TDI CR

Kody silników / Engine codes / Коды двигателя

ANY, ASZ, ATD, AMF, ATL, BHC, AXR, AVB, AVX, AMF, BMS, BNM, BNV, ANU, ARL, AUY, BTB, BVK, BJB, BKC, AZV, BKD, AXB, AXC, BDJ, BST, AJM, AYZ, BWB, BAY, AXG, AXL, AYC, AVQ, BMP, BRM, BRU, BSU, BXE, BXF, BMM, BDK, AZU, BMN, ATJ, BGW, BHW, ACY, AHY, AJ
OEM: T10123 | T10120 | 3458 | 3418 | 2065A | 3366 | T10098 | T10121 | 3242 | T10050 | T10100 | T10060A | T10020 | T10008 | T40011 | 3359 | 2064 | 3369 | T10016 | T10264 | T10265

Ref.	📦	EAN
11-304	1/4	5907558436099

NEO
TOOLS



VAG



AUDI: A3, S3, A5, A6, TT (03-11), SEAT: Ibiza, Leon, Altea, Exeo (04-11)
SKODA: Fabia II, Octavia II, Roomster, Superb II (04-11), VW: Golf, Golf Plus, Jetta, Eos, Scirocco, Tiguan, Touran, Passat (03-11)



Kody silników / Engine codes / Коды двигателя:

2.0FSI: AXA, AWX, BHD, BLR, BLX, BLY, BMB, BVX, BVB, BVZ
2.0TFSI: AXH, BGB, BHZ, BPG, BPJ, BPY, BUL, BWA, BWE, BWJ, BWT, BYD, BYK, BZC, CDLA, CDLB, CDLC, CDLD, CDMA
OEM: T10020 | T10252 | T10092 | T10115 | T10060A | 3366 | T40011

Ref.	📦	EAN
11-306	1/10	5907558436112

Zestaw blokad rozrządu

Timing tool set / Nockenwellen-Arretierwerkzeugsatz / Набор фиксаторов распределения для установки фаз ГПМ / Набор стопорів для розподілювальних валів / Vezérműtengely blokkoló készlet / Set de blocarea distribuției / Sada blokovací pro opravu rozvodů / Súprava blokad rozvodov / Set blokad gredi / Paskirstymo velenėlių fiksavimo komplektas / Sadales mehānismu fiksatoru komplekts / Jaotuse blokeerimise komplekt / Комплект блокировки на газораспределении / Set alata za blokiranje radilice / Pribor za blokadu razvođenja / Σετ συγκράτησης κινωδοφόρων αξόνων / Kit de bloqueo de la correa de distribución / Attrezzi di blocco dell'albero a camme / Conjunto de bloqueios de engranagem de distribuição / Set van distributievegrendeling

NEO
TOOLS



Audi: A1 (10-15), A3 (03-13)
Seat: Alhambra (10-15), Altea/Altea XL (08-15), Ibiza/Cordoba (08-12), Leon (07-13), Toledo (07-15)
Skoda: Fabia II (07-15), Octavia II (04-15), Praktik (10-15), Rapid (12-15), Roomster (06-15), Superb II (09-14), Yeti (09-14)
VW: Beetle (11-15), Caddy/Caddy Maxi (10-15), EOS (06-12), Golf (03-12), Golf Plus (03-14), Golf V Estate (07-13), Golf VI Cabriolet (10-15), Jetta (06-14), Passat (05-11), Polo (02-14), Scirocco (08-12), Tiguan (07-12), Touran (03-15)



Kody silników / Engine codes / Коды двигателя:

1.2 TFSI: CBZA, CBZB, CBZC
1.4 FSI: AXU, BKG, BLN
1.4 TFSI: BLG, BMY, BWK, CAVA, CAVB, CAVC, CAVD, CAVE, CAVF, CAXA, CAXC, CDGA, CSMA
1.6 FSI: BAG, BLF, BLP, BTS
OEM VAG: T10170, T10171A, T40011, T10340, T10414

Ref.	📦	EAN
11-305	1/10	5907558436105

NEO
TOOLS



Audi: A1 - A1 Sportback - A3 - A3 Sportback - A3 CABRIO - S1 - S1 Sportback
SEAT: Alhambra - Altea - Altea XL - Ibiza - Leon - Cordoba - Toledo
SKODA: Octavia II - Praktik - Roomster - Suberb II - Yeti - Yeti Outdoor - RAPID - Rapid Spaceback - Superb II
VW: Beetle - Caddy - Caddy Maxi - Eos - Golf Plus - Golf V - Golf V Estate - Golf VI - Golf VI Cabrio - Golf VI Estate - Jetta - Passat - Polo - Scirocco - Sharan - Tiguan - Touran - CC



Kody silników / Engine codes / Коды двигателя:

1.2 FSI/TFSI: CBZA - CBZB - CBZC
1.4 TSI /1.4 / 1.6 FSI: AXU - BAG - BKG - BLF - BLG - BLN - BLP - BMY - BTS - BWK CAXA (03-)

OEM VAG: T10340, T10414, T10171A, T40011, T10170, VAS6079, T10341

Ref.	📦	EAN
11-307	1/5	5907558436129

NEO
TOOLS



Audi: A3 (2013-)
Seat: Mi (2012-), Leon (2012-), Toledo (2012-) Skoda: Citigo (2012-), Octavia (2013-), Rapid (2012-)
VW: Up (2012-) and Polo mk5 (2014-), Golf VII (2012-), Jetta (2012-)



1.0 Ecofuel, Ecomotive, Bluemotion, Green Tech CHYA, CHYB, CPGA
1.2 TFSI: CJZA, CJZB
1.4 TFSI: CMBA, CXSA, CHPA
1.4 TGI: CPWA
1.4 TSI Multi Fuel CPVA
1.4 Hybrid CRJA
OEM VAG: T10340, T10477, T10476, T10499, T10494, T10487

Ref.	📦	EAN
11-338	0/2	5907558451214

NEO
TOOLS



116i E81/E82/E7/88 (07-12), 118i E81/E82/E7/88 (06-14), 120i E81/E82/E7/88 (06-14)
BMW 3 Series: 316i E90/E91/E92/E93 (07-11), 318i E90/E91/E92/E93 (07-13), 320i E90/E91/E92/E93 (07-14)
BMW 5 Series: 520i E60/E61 (07-10)



Kody silników / Engine codes / Коды двигателя:
N43: B16A/AA, B16AA, B16AA/00, B20A, B20A/AA, B20AA, B20AY, B20KO, B20U0
OEM BMW: 11.8.690 (11.8.691/11.8.692/11.8.693), 11.9.340 (11.9.341/11.9.342), 11.8.710 (11.8.711/11.8.712), 11.3.340, 11.5.120, 11.8.700

Ref.	📦	EAN
11-310	1/5	5907558436136

NEO
TOOLS



BMW 1 Series: 118i E81/E82/E7/88 (04-14), 120i E81/E82/E7/88 (04-14)
BMW 3 Series: 316i/ti Compact E46 (01-07), 318i/ti Compact E46 (01-07), 318i E90/E91/E92/E93 (05-12), 320i E90/E91/E92/E93 (05-14)
BMW 5 Series: 520i E60/E61 (07-10)
BMW X Series: X1 E84 sDrive 18i (10-12), X1 E84 xDrive 18i (10-12), X3 E83 2.0 (05-10)
BMW Z Series: Z4 2.0 E85/E86 (04-09),



Kody silników / Engine codes / Коды двигателя:

2.0:
N42 B18A, N42 B20A, N46 B18, N46 B20, N46 B20B, N46T B20, N46T B20B, N46T B20BD, N46T B20BZ, N46T B2002, N46T B202
OEM BMW: 11 9 310 | 11 9 320 | 11 9 302 | 11 9 301 | 11 9 290 | 11 9 302 | 11 9 340 | 11 9 390 | 11 9 350 | 11 9 270 | 11 2 300 | 11 9 190 | 11 9 330

Ref.	📦	EAN
11-313	1/5	5907558436167

NEO
TOOLS



BMW 1 Series: 118i E81/E82/E7/88 (04-14), 120i E81/E82/E7/88 (04-14)
BMW 3 Series: 316i/ti Compact E46 (01-07), 318i/ti Compact E46 (01-07), 318i E90/E91/E92/E93 (05-12), 320i E90/E91/E92/E93 (05-14)
BMW 5 Series: 520i E60/E61 (07-10)
BMW X Series: X1 E84 sDrive 18i (10-12), X1 E84 xDrive 18i (10-12), X3 E83 2.0 (05-10)
BMW Z Series: Z4 2.0 E85/E86 (04-09),



Kody silników / Engine codes / Коды двигателя:

2.0: N42 B18A, N42 B20A, N46 B18, N46 B20, N46 B20B, N46T B20, N46T B20B, N46T B20BD, N46T B20BZ, N46T B2002, N46T B202
OEM BMW: 11.9.301, 11.9.303, 11.9.310, 11.9.320, 11.9.390

Ref.	📦	EAN
11-312	1/5	5907558436150

Zestaw blokad rozrządu

Timing tool set / Nockenwellen-Arretierwerkzeugsatz / Набор фиксаторов распределения для установки фаз ГРМ / Набор стопорів для розподілювальних валів / Vezérműtengely blokkoló készlet / Set de blocarea distribuției / Sada blokovací pro opravu rozvodů / Súprava blokáď rozvodov / Set blokad gređi / Paskirstymo velenėlių fiksavimo komplektas / Sadales mehānisma fiksatoru komplekts / Jaotuse blokeerimise komplekt / Комплект блокировки на газораспределительном валу / Set alata za blokiranje radilice / Pribor za blokadu razvođenja / Σετ συγκράτησης κινωδοφόρων αξόνων / Kit de bloqueo de la correa de distribución / Attrezzi di blocco dell'albero a camme / Conjunto de bloqueios de engrenagem de distribuição / Ensemble de verrouillage de distribution / Set van distributievengrendeling

NEO TOOLS



NEO TOOLS



BMW 1 Series: 125i E88 (07-13), 128i E82/88 (07-08), 130i E81/87 (05-12), 135i/S E82 (07-11), M Coupe (11-12)
 BMW 3 Series: 323i E90/91/92/93 (04-11), 325i E90/91/92/93 (05-13), 328i E90/91/92/93 (04-08), 330i E90/91/92/93 (04-14), 335i E90/91/92/93 (05-11)
 BMW 5 Series: 523i/Li E60/61/F10/11 (04-11), 525i E60/61 (04-10), 528i E60/61/F10/11 (06-11), 530i E60/61/F10/11 (04-13), 535i E60/61 (06-08)
 BMW 6 Series: 630i E63/64 (04-11)
 BMW 7 Series: 730i E65/66 F01/02/04 (04-11), 740i F01/02/04 (08-12)
 BMW X Series: X1 E84 xDrive 20i (11-14), X1 E84 sDrive 20i(11-14), X1 E84 xDrive 28i(11-14), X1 E84 3.0 xDrive25i (10-11), X1 E84 xDrive28i (09-11), X3 F25 20i (11-14), X3 E83 2.5Si (06-10), X3 E83 3.0i/Si (06-10), X3 F25 3.0 xDrive 28i (11-13), X5 E70 3.0Si/xDrive 30i (06-10), X6 E71/72 3.0 xDrive35i (08-10)
 BMW Z Series: Z4 E85/86 2.5i/Si (05-09), Z4 E85/86 3.0i/Si (05-09), Z4 E89 2.5 sDrive23i (09-11), Z4 E89 3.0 sDrive 30i (09-11), Z4 E89 3.0 sDrive 35i/si (09-13)



Kody silników / Engine codes / Коды двигателя:
 N52/N52K: B25A, B25A/O1, B25AE, B25AF, B25BE, B25O1, B25O2, B25U1, B30/O2, B30A, B30A/O1, B30AE, B30AF, B30O2, B30U1
 N53/N54: B25A, B30A, B30A/AA, B30A/OO, B30A/TO, B30OO, B30TD, B30UO
 OEM BMW: 110300 | 114280 | 114281 | 114282 | 114283 | 114290 | 118520

Ref. 11-311 EAN 5907558436143



BMW:
 118d / 120d: E87:
 318d / 318td Compact / 320td Compact / 320d / 330d: E46:
 316i: 316ti, 318ci, 318ti, 320i E90/E91:
 318i: 320i E90/E91/E92/E93: 520d / 525d / 530d: E39:
 318tds / 318tds Compact (1994-2000) / 325id / tds (1991-99): E36
 525d / 530d / 535d: E60/E61:
 525td/ tds (1991-2003): E34/E39
 635d: E63:
 725tds (1991-2003) M47 / M47 TU / T2 / M57 TU / T2: E38:
 730d: E38/E65/E66:
 X3: 2.0i d / 3.0i d E83:
 X5: 3.0i d E53/E70:
 Land-Rover
 Range Rover: 2.5 TD (1994-2002)
 Range Rover: 3.0 TD6 (2002-2006)
 Freelander: 2.0 TD4 (2002-2006)



Kody silników / Engine codes / Коды двигателя:
 M41, M51, M47 - M47 TU/T2, M57 TU/T2: 2.0i / 3.0i - 1998 - 2008
 OEM BMW: 11 2 300 | 11 3 320 | 11 3 340 | 11 3 360 | 11 5 180 | 11 6 080 | 11 6 320 | 11 6 321 | 11 6 322 | 13 5 120 | 13 5 190 | 13 5 191 | 13 5 192
 OEM Land Rover: LRT-12-108 | LRT-12-112 | LRT-12-115 | LRT-12-114 | LRT-12-119
 OEM Opel: KM-6267 | KM-6269 | KM-6268 | KM-813 | KM-823

Ref. 11-316 EAN 5907558436198

NEO TOOLS



NEO TOOLS



BMW: N42 / N46 / N46T - Valvetronic
 Seria 1: E87 118i/120i (04-10)
 Seria 3: E46 316i/316ti Compact, 318ti Compact (01-05), 318i (01-07), E90 318i (05-08)
 Seria 5: E90 520i (04-08), X3 E83 2.0i (05-09)



Kody silników / Engine codes / Коды двигателя:
 N46, B18, B20B, B20, N42, B18A, B20A, N46T
 OEM BMW: 11 3 350 | 11 9 293 | 11 9 292 | 11 9 291 | 11 9 291 | 11 9 340 | 11 5 120 | 11 9 270 | 11 9 190

Ref. 11-314 EAN 5907558436174



Citroen: AX, ZX, XM, Xsara, Xantia, Dispatch, Evasion, Berlingo, Jumpy, C2, C3, C5
 Peugeot: 106, 205, 206, 305, 306, 307, 309, 405, 406, 406 Coupe, 605, 607, 806, 807, Express, Expert, Partner, Boxer.



Silniki / Engines / Двигатели:
 Benzyna / Gasoline / Бензин: 1,0 / 1,1 / 1,4 / 1,6 / 1,8 / 2,0 / 2,0 HPI
 Diesel: 1,8 / 1,9 / D / TD 1,4 / 2,0 / 2,2 / HDI 2,1 / 2,2 / 2,5 / TD
 OEM: 4 4507-TJ | 0132X | 9767.89 | 0132X12 | 0132Q | 5711-TA | 4507-TB | 0132R | 9767.27 | 7014-TM | 4507-TA | 0132OZ | 0189-C | 0153G | 0153Y | 0153N | 0188D | 7017-TR | 0118X | 7004-TG | 7014-TJ | 7017-TR | 0132AB | 4527-TS2 | 5711-TD | 0189-B | 5711-TC | 9041-TZ | 0188-H | 4527-T-S1 | 0132AJ2 | 0188M | 4533-TAC2 | 0132AJ1 | 4533TACT | 0189-A | 0189AZ | 0189-L | 0188Y | 0288D | 7099-TM | 7014-TJ | 0188P/P2 | 7015T | 0134AF | 0188F | 9044

Ref. 11-320 EAN 5907558436211

NEO TOOLS



NEO TOOLS



Kody silników / Engine codes / Коды двигателя:
 N47, N47S D20A, N57
 OEM BMW: 11 6 480 | 11 8 760 | 11 8 740 | 11 8 741 | 118742 | 11 5 320



BMW 1.4 2.0 3.0 d
 118d E81; 118d E87 - (2006-2010)
 120d E81; 120d E82; 120d E87 - (2006-2010)
 123d E81; 123d E82; 123d E87 - (2007-2010)
 318d E90; 318d E91 - (2007-2010)
 320d E90; 320d E91; 320d E92 - (2005-2010)
 520d E60; 520d E61 - (2006-2008)
 X3 2.0d E83 - (2007-2010)

Ref. 11-315 EAN 5907558436181



BMW 3 Series: 318tds E36 (94-99), 318tds Compact E36 (95-00), 325id/tds E36 (91-99)
 BMW 5 Series: 525td/tds E34 (91-96), 525td/tds E39 (97-03)
 BMW 7 Series: 725tds E38 (96-02)
 Land Rover: Range Rover (94-02)
 Vauxhall/Opel: Omega-B (94-01)



Kody silników / Engine codes / Коды двигателя:
 1.7D: M41/174T1 2.5D: M51/256T1, M51/256T1L 2.5D Turbo: M51, 256T, 250T, X250T
 OEM BMW: 11 2 150, 13 5 062, 11 3 340, 11 3 360, 11 3 320, 13 5 120, 11 2 300
 OEM Land Rover: LRT-12-118, LRT-12-112, LRT-12-114, LRT-12-115, LRT-12-119, LRT-12-108
 OEM Vauxhall/Opel: KM-819, KM-826, KM-823, KM-822, KM-811, KM-825, KM-813

Ref. 11-317 EAN 5907558436204

Zestaw blokad rozrządu

Timing tool set / Nockenwellen-Arretierwerkzeugsatz / Набор фиксаторов распределения для установки фаз ГРМ / Набор стопорів для розподілювальних валів / Vezérműtengely blokkoló készlet / Set de blocarea distribuției / Sada blokovací pro opravu rozvodů / Súprava blokad rozvodov / Set blokad gredi / Paskirstymo velenėlių fiksavimo komplektas / Sadales mehānismu fiksatoru komplekts / Jaotuse blokeerimise komplekt / Комплект блокировки на газораспределении / Set alata za blokiranje radilice / Pribor za blokadu razvođenja / Σετ συγκράτησης κινωδοφόρων αξόνων / Kit de bloqueo de la correa de distribución / Attrezzi di blocco dell'albero a camme / Conjunto de bloqueios de engrenagem de distribuição / Ensemble de verrouillage de distribution / Set van distributievergrendeling

NEO
TOOLS



RENAULT
OPEL

NEO
TOOLS



PSA



RENAULT: Clio, Clio Sport, Twingo, Kangoo, Megane, Scenic, Laguna, Espace, Safrane, Spider, R19, Master, Trafic
OPEL: Arena, Movano
VOLVO: S40, V40
Gasoline engine: 1.2 / 1.4 / 1.6 / 1.7 / 1.8 / 2.0 / 2.2 / 1.4 16V / 1.6 16V / 1.8 16V / 2.0 16V / 2.5 20V
Diesel Engine: 1.9 / 2.5 / 2.8



Kody silników / Engine codes / Коды двигателя:
B16, B18, B20, N70, N7U, K4J, K4M, F4P, F4R, D7F, E5F, E7F, E7J, K7M, F1N, F3N, F3P, F3R, F3R, F7P, F7R, J5R, J7R, J5T, F8M, F8Q, G8T, J8S, F9D, S8U, S9U, S9W

OEM: MOT1348 | MOT1312 | MOT1135 -01 | MOT1384 | MOT1337 | MOT1496 | MOT910-1 | MOT910 | MOT861 | MOT863 | MOT1054 | MOT1318 | MOT1489 | MOT1340 | MOT1386 | MOT1490-1

Ref. EAN
11-322 1/4 5907558436235



Citroen: C4 Picasso/Grand Picasso (06-10), C5 II (04-08), C8 (05-10), Dispatch/Jumpy (07-11), Xsara 2.0 16v, C5 1.8/2.0/HPI, Xsara Picasso 1.8/2.0 16v (02-05)
Peugeot: 406 1.8 16v (00-04), 407 (06-10), 807 2.0 16v (02-05)



Kody silników / Engine codes / Коды двигателя:

1.8 16v: EW7A(6FY)
2.0 16v: EW10A(RFJ), EW10ABE4(RFH), EW10J4S(RFK)
OEM: 0189S1, 0189S2, 0132AB / 0194A/0178D, 0194B, 0188M, 0189B, 0188AH, 0189R, 70177R / 0153U, 0188J2, 0188J/J2, 0178E / 5711TE

Ref. EAN
11-321 1/4 5907558436228

NEO
TOOLS

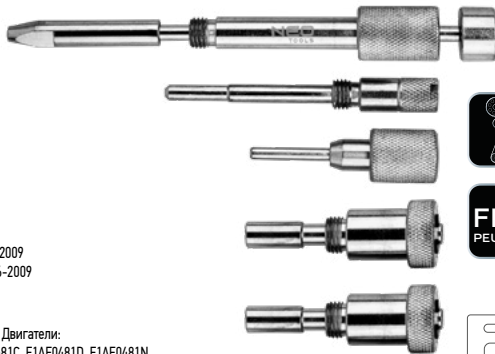

FIAT Ducato, IVECO Daily 2002-2009
CITROEN Relay, Jumper III 2006-2009
PEUGEOT Boxer III 2006-2009



Silniki / Engines / Двигатели:
2.3 JTD - F1AE0481C, F1AE0481D, F1AE0481N,
3.0 JTD - F1CE0481D (2004-)
3.0HDI - F30DT
OEM: 99360614(-), 0191/2.B, 99360615/2.000.018.200(-), 191/2.A, 99360608/1.860.617.000

Ref. EAN
11-325 8/32 5907558436266

NEO
TOOLS



FIAT: Panda, Idea, Doblo
OPEL: Agila, Corsa, Astra H, Tigra B, Meriva
ALFA ROMEO: 147, 156
OPEL: Astra, Vectra, Signum, Zafira



Silniki / Engines / Двигатели:
1.3 JTD MULTIJET (04-07)
1.3 CDTI (04-07)
1.9/2.4 JTD, 16V, 20V
1.9 JTD 16V/2.4 JTD 20V
1.9 CDTI (04-06)
1.7D / 1.9 D FIAT / TD / JTD 2.4

Ref. EAN
11-323 1/4 5907558436242

NEO
TOOLS



FIAT
PEUGEOT

NEO
TOOLS



FIAT
GM



FIAT: Bravo/Brava, Barchetta, Coupe, Doblo Cargo, Idea, Marea/Weekend, Multipla, Siena, Palio/Weekend, Punto, Stilo
Silniki benzynowe / Gasoline engine / Бензиновый двигатель:
1.2; 1.4; 1.6; 1.8 16V
Bravo/Brava, Cargo, Doblo, Ducato, Marea/Weekend, Multipla, Palio/Weekend, Punto, Scudo, Stilo, Ulysse, Dukato, Croma itd



Silniki diesla / Diesel engine / Дизельный двигатель:
1.9D, 1.9TD, 1.9JTD, 2.4TD, 2.4JTD
OEM: 1860847000 | 1860875000 | 1870697000 | 1860895000 | 1895879000 | 1860898000 | 1860992000 | 1860771000 | 1860161000 | 1860874000 | 1860876000 | 1860845000 | 1860876000 | 186095000 | 186091000 | 1860905010 | 1860987000 | 1860985000

Ref. EAN
11-326 1/4 5907558436273



ALFA ROMEO: Mito (10-15)
FIAT: 500 (07-15), 500C (07-15), Doblo/Cargo (05-10), Fiorino (09-15), Grande Punto (07-12), Idea (05-12), Linea (07-11), Panda/Panda Classic (09-13), Panda EVO2 (05-12), Punto EVO (09-12), Punto (12-15), Qubo (09-15), Seicento/600 (00-11)
FORD: Ka (09-15)
LANCIA: Musa (05-13), Ypsilon (06-15)



Kody silników / Engine codes / Коды двигателя:

Fiat: 1.1 8v; 187A1.000, 1.2/1.2 Dualogic; 169A4.000, 188A4.000 (EVO2 only), 199A4.000, 1.4/1.4 Bi-Fuel LPG/1.4 Natural Power CNG; 199A7.000, 350A1.000
Ford: 1.2 Duratec; 169A4.000(FP4)
Lancia: 1.2 8v; 188A4.000, 1.4/1.4 Bi-Fuel LPG; 350A1.000
OEM Ford: 303-1477 | 303-1478 | 303-1480 | 303-1479
OEM Fiat: 2000004200 | 2190754200 | 2000004300 | 2000004400 | 2190754400 | 2191964400 | 2000004500 | 2190754500 | 2191964500 | 1860987000

Ref. EAN
11-324 1/5 5907558436259

Zestaw blokad rozrządu

Timing tool set / Nockenwellen-Arretierwerkzeugsatz / Набор фиксаторов распределителя для установки фаз ГРМ / Набор стопорів для розподільвальних валів / Vezérműtengely blokkoló készlet / Set de blocarea distribuției / Sada blokovací pro opravu rozvodů / Súprava blokad rozvodov / Set blokad gredi / Paskirstymo velenėlių fiksavimo komplektas / Sadales mehānismu fiksatoru komplekts / Jaotuse blokeerimise komplekt / Комплект блокировки на газораспределителе / Set alata za blokiranje radilice / Pribor za blokadu razvođenja / Σετ συγκράτησης κινωδοφόρων αξόνων / Kit de bloqueo de la correa de distribución / Attrezzi di blocco dell'albero a camme / Conjunto de bloqueios de engrenagem de distribuição / Ensemble de verrouillage de distribution / Set van distributievegrendeling

NEO
TOOLS



OPEL:
Astra, Vectra B/C, Zafira, Signum, Frontera
Silnik benzynowy/Gasoline engine:
2.2 16V



Kody silników / Engine codes / Коды двигателя:
ZZ2SE, ZZ2YH

Ref. EAN
11-331 1/5 5907558436297

NEO
TOOLS



OPEL:
AGILA, ASTRA, CORSA, FRONTERA, OMEGA,
SINTRA, VECTRA, TIGRA, ZAFIRA, (SAAB, RENAULT)



Silniki diesla / Diesel engine / Дизельный двигатель:
1.3CDTI 16V, 1.9CDTI, 2.0 Di, 2.2DTI
OEM: KM-952/09912-38310, KM-953/09919-58310,
KM-954/09919-08310, KM-955/09919-58320, KM-
6130

Ref. EAN
11-330 1/2 5907558436280

NEO
TOOLS



FORD:
Focus, C-Max, Mondeo (2003-2010)



Silniki benzynowe / Gasoline engine / Бензиновый двигатель: 1.6 16V
Kody silników / Engine codes / Коды двигателя: HXDA (2003-2007), HXJA, PNBA, RHBA,
Silniki diesla / Diesel engine / Дизельный двигатель: 2.0 TDCi
Kody silników / Engine codes / Коды двигателя: G6DA, G6DB, G6DC (2003-2007)
OEM Ford: 303-1097 | 303-1054 | 303-1059 | 303-1270 | 303-748 | 303-735 | 303-1277 | 21-259 | 21-263
OEM Peugeot: 0188X | 0187B | 0189B | 0188M | 0194B | 0132AJ1
OEM Citroen 0188X | 0187B | 0189B | 0188M | 0194B | 0132AJ1
OEM Renault: MOT1430
OEM Volvo: 9997121 | 9997152 | 9997122

Ref. EAN
11-335 1/10 5907558436334

NEO
TOOLS

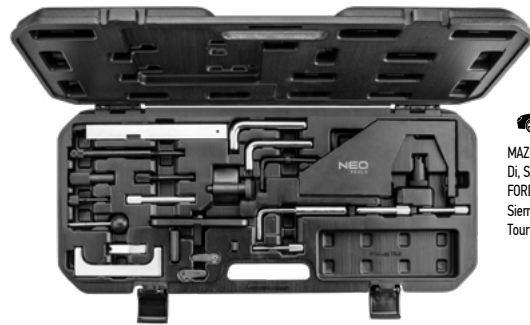

MAZDA: 1.4 1.8 2.0 2.4 2.5 TDCi, TD,
Di, SCI
FORD: Fiesta, Courier, Escort, Orion,
Sierra, Mondeo, Focus, Transit,
Tourneo, Fusion.



Silniki / Engines / Двигатели:
Diesel: 1.4 TDCi, 1.8 D/TD, 1.8 Di, 1.8 TDCi, 2.0TD/TDCi, 2.4 D, 2.5 Di/Turbo/Tci
Benzyna / Gasoline / Бензин: 1.8 Duratec - SCI
Kody silników / Engine codes / Коды двигателя:
C9DC, F9DA/B, C9DA/B, B9DA/B, B9PA, HCPA, FFDA, HCPB, P7PA, P9PA, R2PA, R3PA, RWPA, RFK, RFN, RKD, RTJ, RTK, 4EB,
4EC, 4ED, 4FA, 4FB, 4FC, 4FD, 4GA, 4GB, 4GC, 4GD, 4GE, 4HB, 4HC
OEM Mazda: 49 JE01 061
OEM Ford: 21-162 | 21-162B | 303-367 | 303-376 | 23-059 | 310-085 | 21-168 | 303-393 | 23-020 | 23-047 | 23-020 | 21-163 |
303-620 | 23-019 | 21-210 | 303-507 | 21-251 | 303-698 | 21-262 | 303-734 | 23-029 | 303-1061 | 23-058 | 310-084 | 21-105 |
21-262 | 303-734 | 21-168 | 303-393 | 21-263 | 303-735
OEM VAG: 3359 | T10008 | T10050 | 2065A

Ref. EAN
11-333 1/4 5907558436310

NEO
TOOLS



Chrysler Voyager (2001-2008)
Chrysler Grand Voyager (2001-2008)
Jeep Cherokee (2001-2008)
LDV Maxus (2005-2008)



Kody silników / Engine codes / Коды двигателя:
R2516C, R2516L, R2816K, VM2516L
OEM: VM1052 | VM9660 | VM8873 | VM1080 |
VM1068 | VM1089 | VM1053 Chrysler

Ref. EAN
11-332 1/10 5907558436303

NEO
TOOLS



FORD:
Galaxy, Mondeo, S-Max, Focus 2010-



Silniki benzynowe / Gasoline engine /
Бензиновый двигатель:
2.0 SCTi EcoBoost/Ti-VCT
Kody silników / Engine codes / Коды двигателя:
TNWA / TNWB / TNBA / TPWA / MGDA / XQDA
OEM: 303-748 | 303-1504 | 303-1565 | 303-1521

Ref. EAN
11-336 1/5 5907558436341

Zestaw blokad rozrządu

Timing tool set / Nockenwellen-Arretierwerkzeugsatz / Набор фиксаторов распределения для установки фаз ГРМ / Набор стопорів для розподільвальних валів / Vezérműtengely blokkoló készlet / Set de blocarea distribuției / Sada blokovací pro opravu rozvodů / Súprava blokad rozvodov / Set blokad gredi / Paskirstymo velenėlių fiksavimo komplektas / Sadales mehānismu fiksatoru komplekts / Jaotuse blokeerimise komplekt / Комплект блокировки на газораспределении / Set alata za blokiranje radilice / Pribor za blokadu razvodjenja / Σετ συγκράτησης κωδικοφόρων αξόνων / Kit de bloqueo de la correa de distribución / Attrezzi di blocco dell'albero a camme / Conjunto de bloqueios de engrenagem de distribuição / Ensemble de verrouillage de distribution / Set van distributievergrendeling

NEO
TOOLS



FORD/CITROËN
FIAT/JAGUAR
LAND ROVER
LDV/PEUGEOT



Ford: Mondeo (00-07), Transit (00-14)
Citroen: Relay/Jumper III (06-13)
Fiat: Ducato (06-11) : Ducato (06-11)
Jaguar: X-Type (03-10)
Land Rover: Defender Td4 (06-11)
LDV: Convoy (02-06)
Peugeot: Boxer III (06-12)



Kody silników / Engine codes / Коды двигателя:

2.0D Di/TDci/TDCi: ABFA, D3FA, F3FA, D5BA, D6BA, F1FA, FMBA, FMBB, HJBA, HJBB, HJBC, HJBE, N7BA, N7BB
2.2D TDCi/ECOnetic: BG, CYFA, CYFC, CYFD, DRFA, DRFB, DRFC, P8FA, P8FB, PGFA, PGFB, QJBA, QJBA (BG), QJBB, QJBC, QJBD, QVFA, QVFA, SRFA, SRFB, SRFC, SRFD, SRFE, UHFA
2.2D HDi/JTD:
P22DTE (4HM), P22DTE (4HU), P22DTE (4HV)
2.4D Di/TDCi: DOFA, D2FA, D2FB, D4FA, F4FA, FXFA, H9FA, H9FB, H9FD, JXFA, JXFC, PHFA, PHFC
2.4D TD/Tdi:
ZSD 424
2.4D Td4:
244DT
0EM: 303-679A/21-238, 303-1151, 303-698/21-251, 303-675/21-234

Ref.	Icon	EAN
11-334	1/5	5907558436327

NEO
TOOLS



VOLVO



VOLVO:
Siliniki benzynowe/gasoline engine: 4,5,6 cylinder
S80 (07-), V70 (08-), S80 (-06), XC90, V70 (00-08), V70 XC (01-) / XC70 (-07), S60, C30, C70 (06-), S40 (04-), V50, S40 (-04), V40, 850, C70 Coupe (-05), S70, V70 (-00), V70 XC (-00), 960, S90, V90



Kody silników / Engine codes / Коды двигателя:
B41XX, B42XX, B52XX, B62XX, B63XX, GB52525

Ref.	Icon	EAN
11-337	1/2	5907558436358

Ściągacz uniwersalny

Universal pulley puller / Universalabzieher / Универсальный съёмник / Знімач універсальний / Univerzální agylehúzó / Extractor universal / Univerzální stahovák / Univerzálny stahovák / Univerzalni izvlekač / Univeršalnu nutraukiklits / Univeršālais novilcējs / Univeršaalne tōtmittis / Универсален събо за демонтаж / Univerzalni skidač / Univerzalna alatka za skidanje / Εξωλέκας γενικής χρήσης / Extractor universal / Estrattore universale / Extrator universal / Extracteur de poulie universel / Univeršiele poelietrekker

NEO
TOOLS

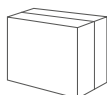

Ref.	Icon	EAN
11-299	1/10	5907558436044

Nasadki do sondy lambda i wtryskiwaczy

Oxygen sensor and fuel injectors wrench set / Aufsätze für lambda-sonden und einspritzdüsen / Набор насадок для лямбда-зонды и форсунок / Насадки до лямбда-зонды и форсунок / Injektor és lambdaszonda szerelő készlet / Ajutaj pentru sonda lambda și injectoare / Klíče na lambda sondy a vstříkací trysky / Nástavce na lambda sondu a vstrekače / Nasadni ključci za sonda lambda in injektorji / Galvučių rinkinys liambda zondui ir purkštukams / Lambda zondes un sprauslu uzgoļi / Lambda sondi otsakud ja pihustid / Накрайниці за лямбда сонда и за инжектори / Nasadni ključevi za lambda sondu ubrizgivača / Nastavci za sondu lambda i brizgalice / Σετ καρβύκια και ακροφύσια για αισθητήρα λямбда και εγχυτήρες / Casquillos para sonda lambda y para inyector / Bussole per sonda lambda e iniettori / Bocais para a sonda lambda e injetores / Douilles pour sondes lambda et injecteurs / Doppen voor lambdasonde en inspuiters

NEO
TOOLS



- 78 mm x 17, 19, 27, 28, 30 mm
- 80 mm x 27 mm
- 85 mm x 21 mm
- 90 mm x 22 mm
- 110 mm x 27 mm

Nasadka sześciokątna 1/2" do sondy lambda / 6 point socket 1/2" for oxygen sensors / Головка 6-гранная 1/2" для лямбда-зонда:

- 80 mm x 20 mm
Nasadki odgięte do sondy lambda / Offset sockets for oxygen sensors / Головки для лямбда-зонда:

- 31 mm x 22 mm x 3/8"

- 50 mm x 22 mm x 1/2"

Nasadki dwunastokątne 1/2" do wtryskiwaczy / 12 point sockets 1/2" for diesel injectors / Головки 12-гранные для форсунок:

- 110 mm x 22 mm
- 150 mm x 22 mm

Ref.	Icon	EAN
11-880	0/5	5907558436877

NEO
TOOLS



Nasadki dwunastokątne 1/2" do sondy lambda / 12 point sockets 1/2" for oxygen sensors / Головки 12-гранные для лямбда-зонда:

- 78 mm x 22, 28 mm
- 80 mm x 27 mm

Nasadka sześciokątna 1/2" do sondy lambda / 6 point socket 1/2" for oxygen sensors / Головка 6-гранная 1/2" для лямбда-зонда:

- 90 mm x 29 mm

Nasadki sześciokątna 3/8" do sondy lambda / 6 point sockets 3/8" for oxygen sensors / Головка 6-гранная 3/8" для лямбда-зонда:

- 74 mm x 27 mm
- 80 mm x 22 mm
- 90 mm x 22 mm

Odgięte nasadki do sondy lambda / Offset sockets for oxygen sensors / Головки для лямбда-зонда:

- 31 mm x 22 mm x 3/8"

- 50 mm x 22 mm x 1/2"

Nasadka dwunastokątna 1/2" do wtryskiwaczy / 12 point socket 1/2" for diesel injectors / Головка 12-гранная 1/2" для форсунок:

- 108 mm x 22 mm

Ref.	Icon	EAN
11-882	0/5	5907558436891

Klucze nasadowe do sondy lambda

Oxygen sensor socket wrench / Aufsatzschlüssel für lambda-sonde / Торцевые головки для лямбда-зонда / Ключи торцеві до лямбда-зонды / Lambdaszonda szerelő készlet / Chei tubulare pentru sonda lambda / Nástrčné klíče pro sondy lambda / Nástavcové klíče na lambda sondu / Nasadni ključci za sonda lambda / Galvutės liambda zondui / Muciņatslēgas liambda zondei / Lambda sondi vōti / Ключови накрайниці за лямбда сонда / Nasadni ključevi za lambda sondu / Ključ natičak za sonda lambda / Καρβύκια για αισθητήρα λямбда / Llave de vaso para sonda lambda / Set di bussole per sonda lambda / Chaves articuladas para a sonda lambda / Clé à sonde lambda / Dopsleutels voor lambdasonde

NEO
TOOLS



1/2" x 29 x 90 mm (wycięcie 8 mm)
1/2" x 27 x 80 mm
3/8" x 7/8" x 90 mm (wycięcie 20 mm)
3/8" x 1-1/16" x 74 mm
3/8" x 7/8" x 80 mm
1/2" x 22 x 50 mm
3/8" x 22 x 31 mm

Ref.	Icon	EAN
11-881	0/10	5907558436884

Klucze nasadowe do sondy lambda

Oxygen sensor socket wrench / Aufsatzschlüssel für lambda-sonde / Торцевые головки для лямбда-зонды / Ключи торцевой до лямбда-зонды / Lambdasonda kulcs készlet / Chei tubulare pentru sonda lambda / Nástrčné kľúče pro sondy lambda / Nástavcové kľúče na lambda sondu / Nasadni ključji za sondo lambda / Galvutės liambda zondui / Muciņatslēgas lambda zondei / Lambda sondi vōti / Ключови накрайници за лямбда сонда / Nasadni ključevi za lambda sondu / Кључи натикач за сонде lambda / Καρυδάκια για αισθητήρα λямбда / Llave de vaso para sonda lambda / Set di bussole per sonda Lamda / Chaves articuladas para a sonda lambda / Clé à sonde lambda / Dopsleutels voor lambdasonde

NEO
TOOLS



Otkienka w nasadkach pozwalają na montaż bez demontażu przewodów
Nasadki pasują do popularnych aut osobowych poruszających się po europejskich drogach
Open-sided for lambda probe fitting without the removal of cables
The sockets fit popular European cars

Благодаря отверстиям в головках, отсутствует риск повреждения топливных трубок
Головки подходят для обслуживания большинства автомобилей, передвигающихся по европейским дорогам

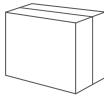

Nasadka koronowej sondy lambda (gorącej) / The socket for end lambda probes (hot) / Головка для горячего лямбда-зонды 1/2", 22 mm x 50 mm
Nasadka szujnika podciśnienia i sondy lambda (do sond nisko osadzonych) / The socket for end lambda probes (hot) / Головка для горячего лямбда-зонды 3/8", 22 mm x 30 mm
Nasadka szujnika podciśnienia i sondy lambda / The socket for vacuum sensor and lambda probe / Головка для датчика вакуума и лямбда-зонды 3/8", 22 mm x 80 mm

Ref.	📦	EAN
11-203	0/20	5907558416763

Klucz do sondy lambda

Oxygen sensor socket wrench / Schlüssel für lambda-sonde / Ключ для лямбда-зонды / Ключ до лямбда-зонды / Lambdasonda kulcs, rövid / Cheie pentru sonda lambda / Kľúč na lambda sondy / Kľúč na lambda sondu / Kļučis za sonda lambda / Raktas liambda zondui / Lambda zondes atslēga / Lambda sondi vōti / Ключ за лямбда сонда / Кључи за sonda lambda / Кључи за сонду lambda / Кλειδί αισθητήρα λямбда / Llave para sonda lambda / Set di bussole per sonda Lamda / Chave para a sonda lambda / Clé à sonde lambda / Sleutel voor lambdasonde

NEO
TOOLS

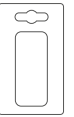

Nasadka do długich sond lambda i tam gdzie złącze przewodów nie pozwala na zastosowanie typowej nasadki do sond ze szczeliną
The socket is suitable for long lambda probes and wherever cable connectors do not allow for using typical probe sockets with a gap

Головка для снятия длинных датчиков кислорода, а также для работы в местах, в которых невозможно использовать типовую головку для лямбда-зонды с зазором

Ref.	W [mm]	📦	EAN
11-204	22	10/100	5907558416749

NEO
TOOLS



Nasadka do krótkich sond lambda
The socket is suitable for short lambda probes
Головка для коротких лямбда-зондов

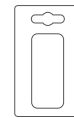

Ref.	W [mm]	📦	EAN
11-205	22	10/50	5907558416756

Ściągacze do wtrysków z młotkiem bezwładnościowym

Fuel injector extractor service set / Abzieher für Einspritzungen mit Trägheitshammer / Комплект для снятия дизельных форсунок с обратными молотками / Комплект знімачів форсунок зі зворотним молотками / Befestigungszugwerkzeug für Injektoren / Instalații de decapare pentru injectori cu ciocan inertial / Sada na vstřikovače s reverzním kladivem / Sťahovky vstrekačov so zotrvačným kladivom / Izvlekači za injektorje z inercialnim kladivom / Dizelinių purkštukų nuėmimo komplektas su atbuliniu plaktuku / Dizela sprauslu noņēmtāju komplekts ar inercialu āturu / Kūtusepūhusti tōmmitasad, inertshaaamriga / Инструмент скоба обратен чук за вадење на дюзи / Skidači za ubrizgivače s inercialnim čekićem / Komplet atlatki za skidanje mlaznica sa inercialnim čekićem / Σετ εξαγωγής ακροφυσίων εγκυτήρα νιζέζελ με σφαιρικά ολίσθησης, κεφαλές / Extractores para inyección con martillo de inercia / Estrattori per iniettori con martello inerziale / Fresas para limpeza de encaixes de injetores / Kit extracteur injection diesel avec marteau coulissant / Injectietrekkers met glijhamer

NEO
TOOLS

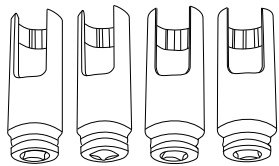

25, 27, 29, 30 x 100 mm

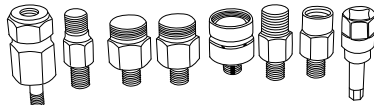

M14 x 1.5 - Delphi,
M17 x 1; M27 x 1 - Bosch
M20 x 1 - Denso,
M24 x 1; M27 x 1 - Siemens,
M14 x 1.5P

NEO
TOOLS



1.6 kg / 160 mm
2.7 kg / 460 mm
5.1 kg / 600 mm

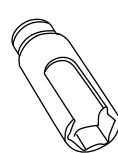

3 x M27 x 1 mm
1 x M25 x 1 mm



3 x M27 x 1 mm,

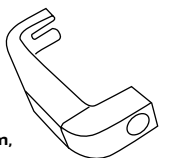

25, 27, 28, 29, 30 x 100 mm 35 x 29 mm / M17 x 1 mm 13.7 x 18 x 105 mm 12.7 x 19 x 135 mm



Ref.	📦	EAN
11-883	1/2	5907558435405



Ref.	📦	EAN
11-884	1/1	5907558435412

Frezy do czyszczenia gniazd wtryskiwaczy

Diesel injector seat cleaning / Fräsen zur Reinigung von Einspritzungsbuchsen / Набор для чистки посадочных мест дизельных форсунок / Набор для чищення посадкових місць дизельних форсунок / Injektor fészek maró és tisztító készlet / Freze pentru curățarea prizelor injectoarelor / Frézy na čištění sedel vstřikovačů / Frézy na čistenie zásuviek vstrekovačov / Orodje za čiščenje ležišč injektorjev / Dyzelinijų purkštukų lizdų valymo įrankių rinkinys / Dizela sprauslu ligzdu tīrītāji / Pihustipesade puhastamise freesid / Фрезы за почистване на леглото на инжектору / Set za čiščenje priključka ubrizgivača / Pribor za čiščenje utičnica ubrizgivača / Σετ καθαρισμού υποδοχών ακροφυσίων εγχυτήρα ντίζελ / Fresas para la limpieza de las tomas de los inyectores / Frese per la pulizia delle sedi degli iniettori / Fresas para limpeza de encaixes de injetores / Kit de nettoyage pour sièges d'injecteurs / Freesstukken voor reiniging van injectie nesten

NEO
TOOLS



14 x 14 mm, 15 x 19 mm, 15,5 x 15,5 mm, 17 x 17 mm, 17 x 17,5 mm, 17 x 19 mm, 17 x 19,5 mm, 17 x 20 mm, 19 x 21,5 mm



15,5 x 15,5 mm, 17 x 17 mm, 17 x 21 mm, 17,5 x 20,5 mm



NEO
TOOLS

CrV
steel

x4



Frez do gniazd zaworowych diesel. Zawartość: frez 15 mm płaski frez uniwersalny, 17 mm frez płaski dla wtryskiwaczy, Delphi/Bosch (BMW/PSA/Renault/Ford), 19 mm Frez płaski dla wtryskiwaczy Bosch (Mercedes CRD), 19 mm Frez kątowy dla wtryskiwaczy Fiat/Iveco, Trzpień pilotujący 19 mm HEX

Diesel injector seat cutter set 4 pcs. Edge trimming cutter 15 mm flat, universal, 17 mm flat for Delphi/Bosch injectors (BMW/PSA/RENAULT/FORD), 19 mm flat for Bosch injectors (Mercedes CRD), 19 mm angle edge trimming cutter for FIAT/IVECO, Pilot mandrel 19 mm HEX

Фреза для чистки седел дизельных форсунок. В комплекте: плоская фреза 15 мм - универсальное применение, 17 мм плоская фреза для Delphi/Bosch (BMW/PSA/Renault/Ford), 19 мм плоская фреза для Bosch (Mercedes CRD), 19 мм угловая фреза для Fiat/Iveco, держатель-направляющая 19 мм HEX

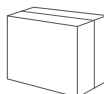

Ref.	📦	EAN
11-218	0/20	5907558420401

Ref.	📦	EAN
11-885	1/5	5907558435429

Zestaw do centrowania tarcz sprzęgła

Clutch center set / Zentriersatz für Kupplungsscheiben / Универсальный набор для центровки дисков сцепления / Набор универсальний для центрування дисків зчеплення / Kuplungtárca központosító készlet / Trusa de centrare a discurilor de ambreiaj / Sada pro centrování spojkových kotoučů / Centrovacia súprava kotúčov spojky / Kľúč za centriranje plošč sklopke / Sankabos diskų centravimo rinkinys / Sąjūga disku centrėšanas instrumentu universālais komplekts / Siduriketaste tsentreerimise komplekt / Комплект за центровка на съединители / Set za centriranje ploča spojke / Pribor za centriranje diskova kvačila / Σετ κεντραρίσματος δίσκων συμπλέκτη / Kit de centrado de la placa de embrague / Kit per il centraggio del disco frizione / Kit de centragem de discos de embraiagem / Kit de centrage pour disques d'embrayage

NEO
TOOLS



11, 12, 15, 17, 19, 20, 21, 25 mm



NEO
TOOLS



DCT
FORD
VOLVO

Volvo: C30, C70 (06->), S40 (04->), S60 (11->), S80(07->), S80L, V40 (13->), V40 Cross Country, V50, V60, V70(08->), XC60 Ford: Focus(04->), C-Max, S-Max, Galaxy, Mondeo (07->), Kuga (13->), zamiennik / replacement / замена OEM: Volvo 9997435, Ford 308-763



Ref.	📦	EAN
11-170	1/10	5907558437348

Ref.	📦	EAN
11-171	1/4	5907558437379

Szczypce do opasek

Clamp pliers / Zange für Kraftstoffleitungen / Щипцы для хомутов / Щипці для шлангів / Bilincsfogó / Clește / Klešče na spony / Kliešte na hadicové spony / Klešče za vzmetne objemke / Replés žarnelių žiedų užspaudimui / Savilceju knaibles / Kaablisidemet tangid / Щипци за проводници на горювето / Kliešta za stiskanje / Klešta za žicu / Λαβίδα στεφανιών στερέωσης / Alicates para bridas / Pinza per morsetti in gomma / Pinças para abraçadeiras / Pince de serrage

NEO
TOOLS

Do opasek sprężających na przewodach olejowych i wodnych etc.
Do pracy w miejscach trudno dostępnych
Długość giętkiej części: 630 mm, długość części z ręką: 210 mm
Zasięg ścisisku: 0 – 45 mm

For spring clips on oil and water hoses
For difficult to reach places
Flexible section length: 630 mm, handle section length: 210 mm
Clamping range: 0 – 45 mm

Для пружинных хомутов топливных, масляных и водяных шлангов и т.п.
Для работы в труднодоступных местах
Длина гибкой части: 630 мм, длина части с рукояткой: 210 мм
Диапазон зажима: 0 – 45 мм

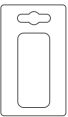
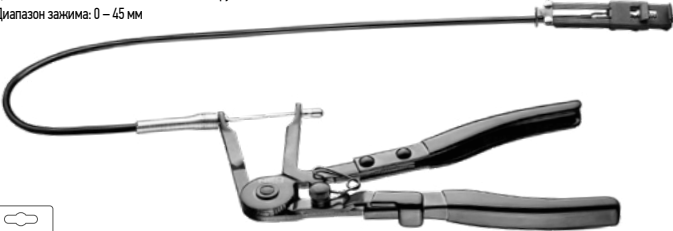

Ref.	W [mm]	⊠	EAN
11-221	840	6/36	5907558416602



NEO
TOOLS



Ref.	⊠	EAN
11-228	1/5	5907558437386

NEO
TOOLS

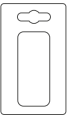

Ref.	⊠	EAN
11-222	0/54	5907558418545

NEO
TOOLS

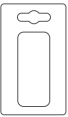

Ref.	⊠	EAN
11-223	6/48	5907558418552

NEO
TOOLS

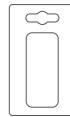

Ref.	⊠	EAN
11-226	6/60	5907558420197

Szczypce zaciskowe z tworzywa

Flexible line clamp / Gripzange aus Kunststoff / Набор зажимов с фиксатором / Кліщі для шлангів / Ünzáró fogókészlet műanyag / Clește de strângere din plastic / Plastové svěrací klešče / Zvieracie plastové kliešte / Plastične klešče za preščiž cevi / Replés stabdžiu šlangelėms užspaudimui / Plastmasas saspiešanas knaibles / Plastist lukustustangid / Стягаючи клеци от пластмаса / Stezna kliešta od umjetnog materijala / Plastična klešta / Σετ σφρυκτήρες με μηχανισμό ασφάλισης / Tenazas abrazaderas de plástico / Pinza occlusion tubo in plastica / Pinças de plástico / Pince de serrage en plastique / Krimptang van kunststof

NEO
TOOLS

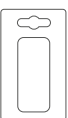

Ref.	⊠	EAN
11-224	0/48	5907558418699

NEO
TOOLS

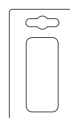

Ref.	⊠	EAN
11-227	24/48	5907558420395

Zestaw mini szczypiec do pierścieni osadzczych

Mini pliers set for circlips / Mini-Zangenset für Stellringe / Набор щипцов для стопорных колец, "mini" / Набор мини-щипцов до стопорных кільць / Mini pliers set for circlips / Garnitura de mini clești pentru inele de strangere / Sada precizních kleštů na pojistné kroužky / Súprava mini klieštů na poistné krúžky / Set mini klešč za objemke / Mini replij komplektas, fiksavimo žiedams / Sprostgredzenu knaibļu komplekts, mini / Lukustusrõngaste minitangide komplekt / Комплект мини щипцов за стопорни пръстени / Set mini seger kliešta za stiskanje i širenje / Komplet mini klešta za talažne prstene / Σετ μικρές λαβίδες για διακτύλια ασφαλείας / Juego de mini alicates para anillos de retención / Kit mini pinze per anelli d'arresto / Pinças para anéis / Jeu de mini-pinces pour colliers de fixation / Set van mini tangen voor dopringen



Zaciskacz do pierścieni

Piston ring compressor / Ringklemme / Оправка поршневых колец / Затискач до кілець / Dugattyúgyűrű szerítő szalag / Strängåtor de inele / Svērka na kroužky / Pás na sťahovanie piestnych krúžkov / Obročni prižemnik / Žiedų suspaudėjas / Gredzenu spasiėdėjs / Vārusulgur / Стяга за пръстени / Stezaljka za prstenje / Stezač za prsten / Συμπιεστής βακτηλιών εμβόλου / Compresor para anillos / Morsetto per anelli / Fixador de anéis / Colier de serrage / Ringklem

NEO
TOOLS

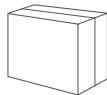

Ref.	Ra [mm]	☒	EAN
11-250	50 - 125	0/60	5907558418330

Klucz do demontażu napinaczy z wymiennymi końcówkami

Tensioner pulley / Schlüssel zum Abbau von Spannern mit auswechselbaren Spitzen / Ключ для снятия переднатяжителей со сменными наконечниками / Ключ для зняття переднатягувачів зі змінними наконечниками / Feszítőörgő kulcs cserélhető fejekkel / Cheie pentru demontarea întinzătoarelor cu capete interschimbabile / Klíč na demontáž napínací kladky s výměnitelnými koncovkami / Kľúč na odstraňovanie napínačov s vymeniteľnými hrotmi / Kľuč za odstranitev zategovalnikov z izmenljivimi konicami / Raktas įtempiklių nuėmimui, su keičiamais antgaliais / Priekšspriegotāja demontāžas atslėga ar maiņas uzgaļiem / Pingūтите eemaldamise vōti, vahetatavate atsakutega / Ключ за демонтiranje на обтяжени ролки със сменяеми накрайници / Kľuč za demontažu zatezaca sa izmenjivim nastavcima / Kľuč za demontiranje zatezaca sa promenljivim krajevima / Κλειδί αφαιρέσης προεντατήρων με αναλλακτικές μύτες / Llave para quitar los tensores con puntas intercambiables / Chiave per smontaggio dei tenditori con punte intercambiabili / Chave para desmontar tensores com pontas substituíveis / Clé de démontage des détracteurs avec embouts interchangeables / Sleutel voor demontage van spanners met eindstukken

NEO
TOOLS

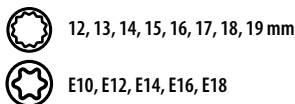

Ref.	☒	EAN
11-169	0/10	5907558437331

Klucz do napinania pasków klinowych

Transmission belt tensioning wrench / Schlüssel zum Spannen von V-Spanngurten / Ключ для затягивания клиновых ремней / Ключ для затягування клинових пасів / Ékszjű feszítő kulcs / Cheie pentru strângerea curelei trapezoidale / Klíč k napínání řemenice / Kľúč na utáňovanie klinových remeňov / Kľuč za napenjanje klinastega jermena / Pleištniņų diržų užvertimo raktas / Transmisijas siksnas pievilksanas atslėga / Kiiirihmade pingutamise vōti / Инструмент за натягане на клинов ремьк / Kľuč za naprezanje remena / Kľuč za zatezanje klinastih remenova / Κλειδί τάνσης σφηνοειδών ιμάντων / Llave para apretar las correas / Chiave per il tensionamento di cinghie dentate / Chave para tensionar correias / Clé pour tendre des courroies / Spanner voor V-snaar

NEO
TOOLS



Ref.	☒	EAN
11-168	1/6	5907558437324

Zestaw do alternatora

Combined sockets for alternator / Lichtmaschinen-Schlüsselsatz / Набор для альтернатора / Набор до генератора змінного струму / Készlet generátor szereléshez / Set de alternator / Sada na alternátor / Súprava pre alternátor / Set za alternator / Rinkinys kintamosios srovės generatoriui / Mainstrāvas ģeneratora instrumentu komplekts / Generatori padrunvōtmete komplekt / Комплект за альтернатора / Garnitura za alternator / Garnitura za alternator / Σετ για εναλλακτήρα / Juego para alternador / Kit per montaggio e smontaggio alternatori / Jogo de acessórios para alternador / Kit d'alternateur / Set voor wisselstroomgenerator

NEO
TOOLS

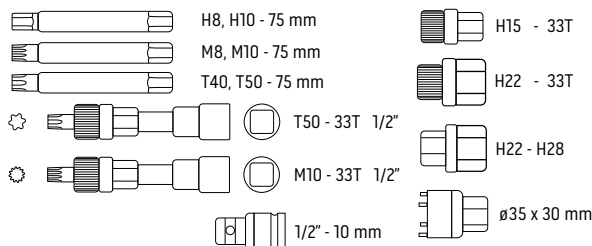

Ref.	☒	EAN
11-167	1/10	5907558437317

Zestaw do układów cieżnienia/podciężnienia

Tester for vacuum and pressure systems / Satz für Druck-/Vakuumsysteme / Набор для напорных / вакуумных систем / Набор для напірних/вакуумних систем / Vákuum és nyomás tesztelő / Set pentru sisteme de presiune / vid / Tester pro tlakové/podtlakové systémy / Súprava pre tlakové / podtlakové systémy / Set za vakuumske in tlačne sisteme / Rinkinys slėgio / vakuumo sistemoms / Spiediena/ vakuuma sistēmu instrumentu komplekts / Rāhu-/vakuumsūsteemide komplekt / Πομα за тестване на вакуум и налягане / Set za sustave tlaka/podtlaka / Pribor za sistem priiška/vakuuma / Σετ για συστήματα κενού αέρος/παροχής υπό πίεση / Probador de sistemas de presión / vacío / Kit per impianti a pressione/in depressione / Kit para sistemas de pressão/subpressão / Testeur de pression / compression / Meter voor druk/onderdruk systemen

NEO
TOOLS

-1÷3
BAR



Ref.	☒	EAN
11-267	1/10	5907558436013

Zestaw do diagnostyki systemów Common Rail

Common Rail diagnostic set / Diagnosissatz für Common-Rail-Systeme / Набор для диагностики систем Common Rail / Набор для диагностики систем комон-рэйл / Common rail rendszer diagnosztikai készlet / Trusă pentru diagnosticarea sistemelor Common Rail / Sada pro diagnostiku systémů Common Rail / Sada pre diagnostiku systémov Common Rail / Set za diagnostiku sistemov Common Rail / Diagnostikos rinkinys, skirtas sistemai Common Rail / Common Rail sistėmu diagnosticėšanas komplekts / Common Rail sistėmide diagnostikakomplekt / Комплект за диагностика на систему Common Rail / Set za dijagnostiku sustava Common Rail / Pribor za dijagnostiku sistema Common Rail / Διαγνωστικό σετ για αυστήματα Common Rail / Set para diagnóstico de sistemas Common Rail / Kit diagnostico per sistemi Common Rail / Kit de diagnóstico de sistemas Common Rail / Kit de diagnostic pour systèmes Common Rail / Common Rail diagnostische set

NEO
TOOLS



BOSCH
SIEMENS
DENSO
DELPHI



Ref. EAN
11-263 1/5 5907558435979

Zestaw do testowania systemów wtryskowych

Fuel injection injector pressure test set / Testsatz für Einspritzsysteme / Набор для проверки форсунки впрыска топлива / Набор для перевірки форсунок вприскування палива / Befestskendő rendszer tesztelő készlet / Set pentru testarea sistemelor de injectie / Sada pro testování vstřikovacíh systémů / Súprava na testovanie vstrekovacích systémov / Set za testiranje injektorskih sistemov / Įpurškimo sistemų testavimo rinkinys / Degvielas iesmidzināšanas sprauslas pārbaudes instrumentu komplekts / Sissepritseüsteemide testimise komplekt / Комплект за диагностика на инжекционни системи / Set za ispitivanje sustava ubrizgivanja / Sistem za testiranje sistema za ubrizgavanje / Σετ ελέγχου ακροφυσίου έγχυσης καυσίμου / Kit para pruebas de sistemas de inyección / Kit per il test di sistemi di iniezione / Kit de testagem de sistemas de injeção / Kit d'essai pour systèmes à injection / Brandstofinjectie test set

NEO
TOOLS



0-10
BAR

Ref. EAN
11-264 1/5 5907558435986

Miernik ciśnienia sprężania

Compression tester / Verdichtungsdruckmesser / Компрессометр бензиновый / Компресометр / Kompresszió mérő készlet / Aparat de măsurat compresia / Měřicí přístroj kompresního tlaku / Merač kompresného tlaku. / Merilec pritiska adapter / Kompresijos matuoklis / Kompresijos manometrs / Manometer adapterite komplekt / Компресометр / Mjerač pritiska / Merač pritiska sabijanja / Συμπιεσόμετρο βενζίνης / Medidor de aire comprimido / Misuratore della compressione / Medidor de pressão de compressão / Compressiometre compression / Meter van persdruk

NEO
TOOLS

70
BAR x16
DIESEL



Miernik kompresji do pomiarów ciśnienia sprężania w cylindrach silników wysokoprężnych (diesla)
Zestaw zawiera różne adaptery pasujące do większości silników aut osobowych i dostawczych
Maksymalny zakres pomiaru – 70 barów

Pressure gauge for measuring compression pressure in diesel engine cylinders
The set includes various adapters suited for a majority of passenger and delivery vehicle engines
The maximum measurement range – 70 bars

Компрессометр для измерения давления в дизельных двигателях
В комплект входят адаптеры, которые подходят к большинству двигателей легковых и грузовых автомобилей
Диапазон измеряемого давления – до 70 бар

Ref. EAN
11-262 0/6 5907558416732

NEO
TOOLS

21
BAR



Miernik kompresji do pomiarów ciśnienia sprężania w cylindrach silników spalinyowych benzynowych
Zestaw zawiera adapter pasujący do większości silników aut osobowych i dostawczych
Maksymalny zakres pomiaru – 21 barów

Compression pressure gauge for measuring compression pressure in petrol combustion engine cylinders
The set includes an adapter suited for a majority of passenger and delivery vehicles
The maximum measurement range is – 21 bars

Компрессометр (тестер давления) для измерения давления в бензиновых двигателях
В комплект входит адаптер, который подходит к большинству двигателей легковых и грузовых автомобилей
Диапазон измеряемого давления – до 21 бар

Ref. EAN
11-261 0/20 5907558416725

Tester ciśnienia turbosprężarki

Turbo pressure gauge / Druckprüfgerät für Turbolader / Тестер турбо давления / Тестер тиску у турбокомпресорі / Turbófeltöltő nyomás tesztelő / Tester de presiune turbocompresor / Manometr pro kontrolu tlaku turba / Tester tlaku turbodúchadla / Preskuševalnik tlaka turbo kompresorja / Turbokompresorij testavimo rinkinys / Turbo spiediena mēritājs / Turbolaaduri rõhu tester / Тестер за налягане на турбокомпресор / Tester pritiska u turbokompresoru / Tester za pritisak turbokompresora / Ελεγκτής πίεσης turbo / Probador de presión para turbocompresor / Tester di pressione per turbocompressori / Aparelho de teste de pressão de turbocompressor / Testeur de pression d'huile turbocompresseur / Turbocompressor druk meter

NEO
TOOLS



-1÷3
BAR

Ref. 11-265
EAN 5907558435993

Tester ciśnienia oleju

Engine oil pressure tester / Druckprüfgerät für Öldruck / Тестер давления масла / Тестер тиску оливи / Olajnyomás tesztelő / Tester de presiune ulei / Tester tlaku oleje / Tester tlaku oleja / Preskuševalnik tlaka olja / Tepalo slégio matuoklis / Είλας spiediena mēritājs / Ölirõhu tester / Тестер за налягането на маслото / Tester pritiska ulja / Tester za pritisak ulja / Ελεγκτής πίεσης λαδιού / Probador de presión del aceite / Tester di pressione dell'olio / Aparelho de teste de pressão de óleo / Testeur de pression d'huile / Motorolie druk meter

NEO
TOOLS



0-10
BAR



Ref. 11-266
EAN 5907558436006

Zestaw kluczy nasadowych do filtra oleju

Car type oil filter wrench set / Steckschlüsselsatz für Ölfilter / Набор торцовых ключей к масляному фильтру / Набор накидных ключів до олійного фільтра / Dugókulcs-készlet olajsűrűhöz / Set de chei tubulare pentru filtru de ulei / Sada miskovitých klíčů na olejové filtry / Súprava nástavcových klúčov na olejový filter / Set nasadnih ključev za oljni filter / Galvučių rinkinys tepalo filtrui / Είλας filtra mucipnatslėgu kompleks / Ölfilteri padrūnviõmete komplekt / Комплект гаечни ключове за масления филтър / Garnitura nasadnih ključeva za filter ulja / Garnitura ključeva natikača za filtere za ulje / Σει μπουλονόκλειδα για φίλτρο λαδιού / Juego de llaves de vaso para filtro de aceite / Completo di chiavi a bussola per il filtro dell'olio / Jogo de chaves tubulares para filtro de óleo / Jeu de clés à douille pour filtre à huile / Set van dopsleutels voor oliefilter

NEO
TOOLS

x30



NEO
TOOLS

x16



Ø	Ø mm	N	
	66/6	6	Fiat Punto 1.2; Renault Clio1.2, Rapid, Twingo
	65/14	14	Daihatsu; Toyota; Nissan; Fiat; Camry
	65/67	14	Daihatsu; Toyota; Mazda; Mitsubishi
	68/14	14	Mazda; Ford; Subaru; Toyota
	73/14	14	Toyota; Lexus
	74/15	15	Audi; Rover; Chrysler; Lexus; GM
	74/76	15	Ford; Opel; VW; Audi; Mercedes; GM
	75/77	15	VW; Audi; Isuzu; Mercedes; GM; Chrysler
	76/12	12	Fiat; Mercedes; Renault
	76/14	14	VW; Porsche; Mercedes; BMW; Audi; Opel; Buick
	76/30	30	Ford; VW; Renault; Peugeot
	76/8	8	Fiat; Lancia
	78/15	15	Nissan; Ford; Toyota
	80/15	15	Nissan; Honda; Opel; Mazda; Iveco

Ref. 11-242
Ra[mm] 66-108
EAN 5907558435955

Ø	Ø mm	N	
	80/82	80	Subaru; Toyota; Honda; Nissan; Iveco; Hyundai; Mazda
	86/16	86	Volvo
	86/18	18	VW Golf; Audi A6 TDI; Peugeot; Citroen
	90/15	90	Honda; Mitsubishi; Isuzu; Mazda
	92/10	92	Fiat
	93/15	93	Mazda; Volvo; Mitsubishi; Nissan; Honda
	93/36	93	Ford; Audi
	93/45	93	VW; Audi TDI
	95/15	95	Toyota; Alfa Romeo; Ford
	96/18	96	Audi A4; A6 TDI; VW Passat TDI; Renault Laguna
	100/15	100	Isuzu; Mitsubishi; Buick; Hyundai; Iveco; Daewoo; Renault
	106/15	106	Fiat Ducato
	108/15	108	Volvo
	108/18	108	Renault Espace; Laguna; Safrane; Traffic

Ref. 11-243
Ra[mm] 65-100
EAN 5907558435962

Nasadka do filtra oleju

Sup type oil filter wrench / Ölfilterkarpen / Съемник масляного фильтра "чашка" / Знімач масляного фільтра "чашка" / Csésze olajsűrő lehúzó / Supő filtru de ulei / Stahovák olejového filtru / Ključ na olejový filter / Ključ za oljni filter / Raktas tepalo filtrui / Atslēga eļļas filtram / Öljüfiltri vöü / Водеца шина за дрза / Ključ za uljni filter / Ključ za uljani filter / Κλειδί φίλτρου λαδιού / Llave para filtro de aceite / Chiave per il filtro dell'olio / Chave p. filtros de óleo / Clef à filtre d'huile / Sleutel voor oliefilter

NEO
TOOLS



3/8"

Ref.	Ø mm	N	Ø	EAN
11-360	76	12	10/60	5907558445299
11-361	65	14	10/60	5907558445305
11-362	67	14	10/60	5907558445312
11-363	73	14	10/60	5907558445329
11-364	76	14	10/60	5907558445336
11-365	74	15	10/60	5907558445343
11-366	78	15	10/60	5907558445350
11-367	80	15	10/60	5907558445367
11-368	90	15	10/60	5907558445374
11-369	95	15	10/60	5907558445381
11-370	108	15	10/60	5907558445398
11-371	86	16	10/60	5907558445404
11-372	86	18	10/60	5907558445411
11-373	96	18	10/60	5907558445428

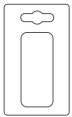

Zestaw do misek oleju

Oil change tool kit / Ölwechsel-Werkzeugsatz / Набор инструментов для замены масла / Набор інструментів для заміни масла / Különleges szerszámkészlet olajcseréhez / Trusa de scule specială pentru schimbul de ulei / Speciální sada náradí pro výměnu oleje / Speciálna sada náradia na výmenu oleja / Orodje komplet posebnih za menjavo olja / Įrankių rinkinys specialus alyvos keitimui / Įrašs instrumentu komplekts eļļas maiņai / Тööriistakomplekt spetsiaalne õlivahetuseks / Комплект инструментов за смяна на масло / Komplet alata poseban za zamjenu ulja / Комплект алата специјални за заменуља / Είδικό kit εργαλείων για αλλαγή λαδιού / Kit de herramientas especial para cambio de aceite / Kit attrezzi speciali per cambio olio / Kit de ferramentas especial para troca de óleo / Kit d'outils spécial pour le changement d'huile

NEO
TOOLS



5
ELEMENTS

1/4"

3/8"



Audi / SEAT / Škoda / VW:
model year 2013 with 1.2 · 1.4 · 1.8 · 2.0 l TFSI petrol engines
Audi: A1, A3, A4, A5, Q5
VW: Golf 7
SEAT: Leon, etc. with 1.6 and 2.0 l diesel engines



OEM: Connect 31775 Peugeot/Citroen (OEM 9801444780 Plug) and Ford (OEM 18711598 plug) Connect 31776 Ford (OEM 1830727 plug) Connect 31774 BMW (OEM 11137605018 plug) Connect 31771 VAG (OEM 06L 103 801 sump and cam cover plug)



Ref.	Ø	EAN
11-384	5/20	5907558452273

Końcówka wkrętakowa do korków oleju

Special bit for oil drain plug / Spezial Bit für Ölablassschraube / Бита специальная для сливной пробки / масляного под / Бита для сливной пробки / Bit az olajdugókhöz / Bit special pentru dopul de scurgere a uleiului / Speciální bit pro vypouštění zátku oleje / Špeciálny bit pre vypúšťacíu zátku oleja / Poseben bit za zamašek za izpust olja / Specialus antgalis alyvos išleidimo kamščiai / Įrašs bit eļļas iztukšošanas aizbāznei / Spetsiaalne ots õli väljalaskekrui jaoks / Ключ за маслену ману / Ključ za čepove za ulje / Ключ за чепове за уље / Кλειδί για βύσματα λαδιού / Llave especial tapón de aceite / Chiave speciale per tappi olio / Chave especial para óleo / Clé à bouchon d'huile spéciale / Speciale olieplugsleutel /

NEO
TOOLS

1/4"



Audi / SEAT / Škoda / VW:
model year 2013 with 1.2 · 1.4 · 1.8 · 2.0 l TFSI petrol engines
Audi: A1, A3, A4, A5, Q5
VW: Golf 7
SEAT: Leon, etc. with 1.6 and 2.0 l diesel engines

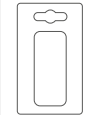

Ref.	Ø	EAN
11-383	20/100	5907558452266

Klucze do spustu oleju

Oil drainer set / Ölablassschlüssel / Ключи для слива масла / Ключи для зливання оливи / Olajleeresztő kulcs készlet / Chei pentru dop de scurgerea uleiului / Klíče na vypúšťení oleje / Sada klíčov na vypúšťanie oleja / Vijaki za spuščanje olja / Raktai alyvos išleidimui / Eļļas nolaišanas atslēgas / Ölkorgi võtmed / Ключове за източване на масло / Ключеви за испуштање улја / Ключеви за испуштање олја / Σετ αποστράγγισης λαδιού / Llaves para evacuación de aceite / Inserti per tappo olio / Chaves para evacuação de óleo / Clés pour la vidange d'huile / Sleutels voor oliedreinage

NEO
TOOLS

CrV
steel

3/8"

x18



Zastosowanie / Application / Применение:

Hex 8 mm: BMW, Ford, GM
Hex 9 mm: GM
Hex 10 mm: Ford
Hex 12 mm: Fiat, Lancia, Peugeot
Hex 14 mm: Lancia, Mercedes
Hex 17 mm: Audi, VW, BMW, Austin
Square 7, 8 mm: Citroen, Peugeot, Renault, Talbot, Volvo
Square 11 mm: Ford
Square 13.1 mm: Nissan, Subaru
Square 3/8": Honda, Mazda, Renault, Saab, Volvo
Square (5/16"), 10 mm Female, Square: 10 mm: do skrzyń biegów i mechanizmów różnicowych różnych marek aut np. / for gearboxes and differential mechanisms of various makes / для коробки передач и дифференциала автомобилей разных марок: BMW, Ford, Renault, Toyota
Triangular: 10 mm Renault
M16 Spline (Tamp-proof): Audi A4 i A6



Ref.	Ø	EAN
11-235	0/10	5907558417098

Klucz do filtra oleju

Oil filter wrench / Schlüssel für Ölfilter / Съёмник масляных фильтров / Ключ для оливных фильтров / Olajsűrő leszedő / Cheie pentru filtre de ulei / Ključ na olejovj filtr / Ključ na olejovj filter / Ključ za oljni filter / Raktas tepalo filtrui / Eljas filtru atslega / Ölfiltrivöti / Ключ за маслен филтър / Ključ za filtre za ulje / Ključ za filter za ulje / Κλειδί αφαίρεσης φίλτρου λαδιού / Llave para filtros de aceite / Chiave per filto olio / Chave para filtros de óleo / Cle filtre a huile / Filtersteutel

NEO
TOOLS

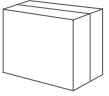

Ref.	Ra[mm]	📦	EAN
11-237	43-102	1/40	5907558437355

NEO
TOOLS

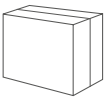

Ref.	Ra[mm]	📦	EAN
11-239	64-100	1/40	5907558435924

NEO
TOOLS

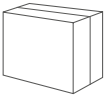

Ref.	Ra[mm]	📦	EAN
11-238	64-120	1/40	5907558437362

NEO
TOOLS

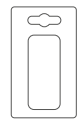

Ref.	Ra[mm]	📦	EAN
11-381	60 - 115	5/20	5907558445459

60-115
mm



1/2"

NEO
TOOLS

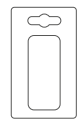

Ref.	Ra[mm]	📦	EAN
11-382	60 - 160	6/24	5907558445466

60-160
mm



NEO
TOOLS

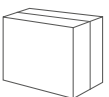

Ref.	Ra[mm]	📦	EAN
11-380	80 - 115	1/20	5907558445442

80-115
mm



NEO
TOOLS



20°

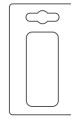

Ref.	Ra[mm]	📦	EAN
11-240	63.5 - 116	6/36	5907558435931

NEO
TOOLS



30°
60°
90°

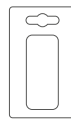

Ref.	Ra[mm]	📦	EAN
11-241	63.5 - 116	5/30	5907558435931

NEO
TOOLS

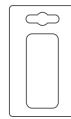

Ref.	Ra[mm]	📦	EAN
11-231	73 - 85	6/36	5907558416657

TOPEX

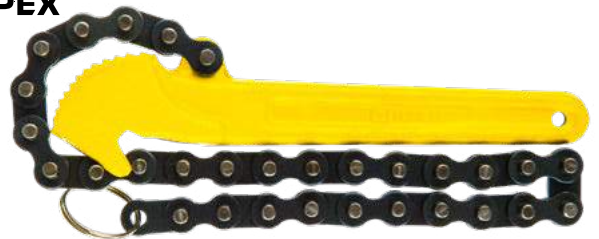

Ref.	Ø max [mm]	📦	EAN
37D204	110	6/36	5902062230379

TOPEX

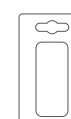

Ref.	Ø max [mm]	📦	EAN
37D207	120	12/120	5902062230386

TOP TOOLS

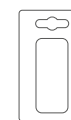

Ref.	📦	EAN
37D205	12/36	5902062040596

Odciągarka do oleju

Oil suction gun / Ölabszieher / Отсосное устройство для масла / Оливодісмонтувач / Olajleszívó / Trägator de ulei / Odsávačka oleje (ruční) / Odsávačka na olej / Črpalka za olje / Alyvos siurblys / Eļļas atvilcējs / Ölisüstal / Засмывающая масляная помпа / Sisaljka za ulje / Putra za ispružavanje ulja / Αναρροφτήρας λαδιού / Dispositivo de extracción de aceite / Pistola di aspirazione olio / Máquina de remover óleo / Vidangeur d'huile / Olieafzuiger

NEO
TOOLS

METAL

280
mm

PRESSOL

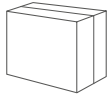
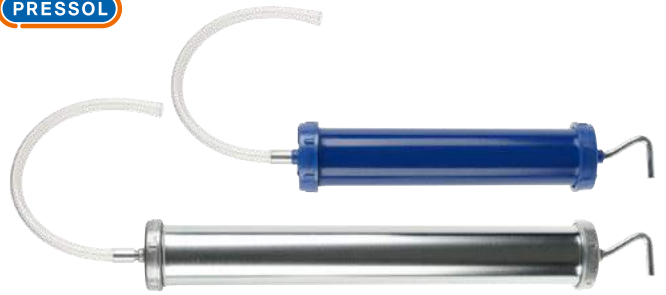

Ref.	[ml]	Ø [mm]	L [mm]	☒	EAN
11-510	500	56,4	280	0/20	5907558415346
11-511	1000	62,5	400	0/10	5907558415353

Ref.	[ml]	☒	EAN
12 902	500	1/0	4103810129025
12 908	1000	1/0	4103810129087

Wanna do oleju

Oil drain bucket / Ölwanne / Ванночка для масла / Ванна оливова / Olajkád / Baie de ulei / Vana na olej / Vaňa na olej / Posoda za olje / Vonele tepalui / Vanniņa eļļai / Ölivann / Вана за масло / Posuda za ulje / Kada za ulje / Λεκάνη αποστράγγισης λαδιού / Bandeja para aceite / Contenitore olio / Bandeja para troca de óleo / Bac à huile

NEO
TOOLS

7
dm³

PLASTIC

PRESSOL



Ref.	☒	EAN
11-550	0/10	5907558415360

6
dm³

PLASTIC



Ref.	☒	EAN
24 110	1/5	4103810241109

Kanister na benzynę

Can for petrol / Benzinbehälter / Канистра для бензина / Канистра для бензину / Üzetanyagkanna, műanyag / Bidon de benzina / Kanistr na benzin / Kanistra na benzin / Kanister za benzin / Bakas benzini / Benzina kanna / Bensiinkanister / Бидон за бензин / Kanister za benzin / Kanta za benzin / Κάνιστρο βενζίνης / Bidón para gasolina / Tanica per la benzina / Tanque para gasolina / Jerrycan à essence / Jerrycan voor benzien

NEO
TOOLS

HDPE
PP
LDPE



Ref.	V [l]	☒	EAN
11-560	10	0/50	5907558436402
11-561	20	0/30	5907558436419

Lejek

Funnel / Trichter / Воронка / Воронка / Tölcsér, flexibilis, szűrővel / Pálnie / Nálevka / Lievik / Lijak / Piltuvēlis / Piltuve / Lehter / Фуння / Lijevak / Levak / Хови / Embudo / Imbuto / Funil / Entonnoir / Trechter

NEO
TOOLS

1,2 L

HDPE
LDPE



Ref.	Ø ₁ [mm]	Ø ₂ [mm]	☒	EAN
11-555	45	160	0/6	5907558436396

PRESSOL



Ref.	Info	☒	EAN
02 366	ø210 x 24,5 mm	1/6	4103810023668
02 372	ø160 x 21,5 mm	1/6	4103810023729
02 562	ø160 x 20,0 mm	1/6	4103810025624

PRESSOL



21 127

21 127-950

Ref.	V [l]	☒	EAN
21 127	20	1/0	4103810211270
21 127-950	20	1/0	4103810424571

TOP TOOLS



x4

Ref.	Ø [mm]	☒	EAN
77P530	50,75,95,115	0/72	5902062173188

Smarownica dźwigniowa

Lever-operated grease gun / Schmier spritze mit Hebel / Шприц рычажно-плунжерный / Шприц важільно-плунжерный / Karos zsírzó / Gresor cu prghie / Páková maznice / Páková mazica / Ročna mazalka / Rankinis tepalo presas / Leelätājs ar sviru / Kangiga määrimisseade / Ръчна масльонка / Mazalica ručna / Mazalica na rupu / Γρασαδόρος με μοχλό / Engrasadora de palanca* / Pistola per grasso / Pistola de lubrificação / Graisseur à levier

NEO
TOOLS

400 cm³ 10000 Psi 8x300 mm



Ref. 11-500 Info. 0/10 EAN 5907558415278

PRESSOL



Ref. 12 632 Info. 500 cm³ + 12 635 + 12 631 EAN 4103810126321

PRESSOL



Ref. 12 630 Info. 500 cm³ + 12 656 + 12 631 EAN 4103810126307

Wężyk do smarownic

Hose for grease gun / Schlauch für Schmiergeräte / Шланг смазочный / Шланг до дозаторів оливи / Zsírzó cső / Furtunpentru pistol de gresare/ungere / Hadička pro mazničky / Hadička do maznic / Cev za mazalnike / Žarnelè tepalinèms / Caurulite eļļas kanniņai / Ölprüstolivoelik / Маркуч за масльонка / Crijevo za mazalice / Crevo za podmazivanje / Εύκαμπτος σωλήνας λίπανσης / Mangueira para engrasadoras / Tubo in Nylon / Mangueira para lubrificadores / Flexible de graisseur / Slang voor smeerapparaten

NEO
TOOLS



do smarownicy 11-500
for 11-500 grease gun
для масленики 11-500

Ref. 11-532 Info. L [mm] 11x300 EAN 5907558415308

PRESSOL



Ref.	info	EAN
12 655-810	11 x 300 mm + 12 631	4103810420290
12 665-810	11 x 500 mm + 12 631	5902062000033
12 656-810	8 x 300 mm + 12 631	4103810426506
12 666-810	8 x 500 mm + 12 631	5902062153371

PRESSOL



Ref. 12 679 Info. 500 cm³ + 12 655 + 12 643 EAN 4103810126796

PRESSOL



Ref. 12 636-101 Info. 500 cm³ + 12 655 + 12 631 EAN 4103810129810

TOPEX

400 cm³ 8x300 [mm]

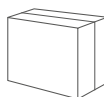
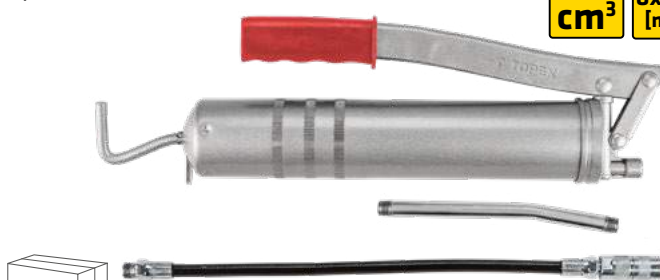

Ref. 97X300 Info. 0/10 EAN 5902062003591

Końcówka smarownicza

Grease coupler / Schmiernippel / Насадка / Наконечник змащувальний / Zsírzófej, négyprófas / Piesa de ungere / Mazací koncovka / Mazací nástavec / Mazalni nastavek / Antgalis / Četřžoklu ieļļošana / Määrimisotsak / Четурчелюстен / Glava mazalice / Podmazna kupa / Тоок урсаодору / Punta de engrase / Terminale a 4 ganasse con attacco M10x1 / Ponta de lubrificação / Embout de graissage

PRESSOL



Ref.	info	EAN
12 643	M10x1	4103810126437
12 631	M10x1	4103810126314

Smarowniczka

Grease nipple / Öl / Масленика / Оливница / Zsírözsem / Cană de ungere / Maznička / Maznička / Mazalica / Tepalo - dozatorius / Eļļa kanniņa / Väike määrdrupp / Ръчна масльонка / Dozer za mazivo / Mala mazalica / Ελαιοβεφαμενή / Engrasadora / Punto de ingrassaggio / Lubrificador / Raccord de graissage / Smeernippel

PRESSOL



Ref.	info	EAN
15 007	H1, M6 x 1	5902062011756
15 009	H1, M8 x 1	5902062011749
15 013	H1, M10 x 1	4103810440144
15 113-140	H2, M10 x 1	5902062153975

Separator

Spreader / Abscheider / Съемник / Сепаратор / Fémunkahenger visszanyomó tárcsafékhez / Separator / Separátor / Separátor / Separatori / Separators / Separador / Сепаратор / Separator / Separator / Διαχωριστής / Separador / Separatore / Separator / Séparateur / Separator

NEO
TOOLS

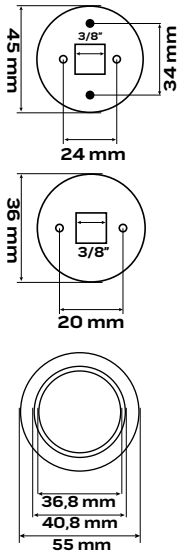

Ref.	Ra[mm]	☒	EAN
11-125	35-90	5/20	5907558437218

NEO
TOOLS

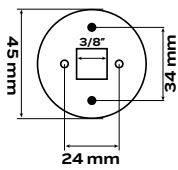

Ref.	Ra[mm]	☒	EAN
11-126	25-60	5/20	5907558437232

NEO
TOOLS

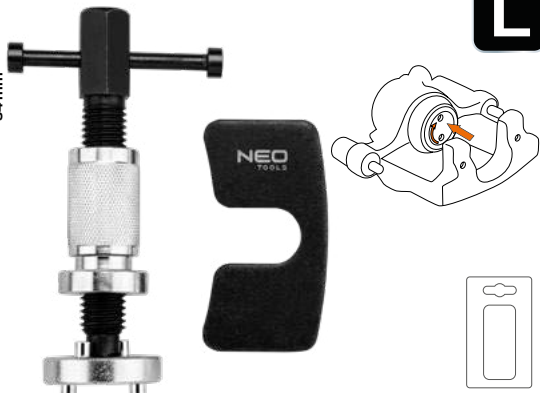
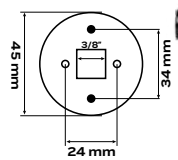

Ref.	Ra[mm]	☒	EAN
11-127	25-60	5/20	5907558437232

NEO
TOOLS



Ref.	Ra[mm]	☒	EAN
11-128	40-70	1/20	5907558437249

Zestaw ręcznych separatorów do zacisków hamulcowych

Set of hand separators for brake calipers / Bremskolbenrückstellersatz / Комплект приспособлений для обслуживания тормозных цилиндров / Набор ручних сепараторів для гальмівних колодок / Tárcsafék szerelő és visszanyomó készlet / Set manual de separatori la cleme de frană / Sada na montáž kotoučových brzd / Súprava na montáž kotúčových brzd / Set ročních ločevalnikov zavornih batov / Stabdžij cilindru suspaudimo komplektas / Bremžu cilindru manuālo separatoru komplekts / Piduriklotside sepaaraarite komplekt / Комплект рьчни сепаратори за спирачните клеми / Set ručních odvařačů za kočione stezaljke / Pribor ručních separatora za kočione stezače / Set συντήρησης κυλίνδρων πέδησης / Juego de separadores manuales para las pinzas de freno / Utensili per il riposizionamento dei pistoncini dei freni / Jogo de separadores manuais para maxilas de travão / Jeu de séparateurs manuels pour étriers de freins / Set voor handmatige afstanders voor remklemmen

NEO
TOOLS



Ref.	☒	EAN
11-123	0/10	5907558419993

NEO
TOOLS

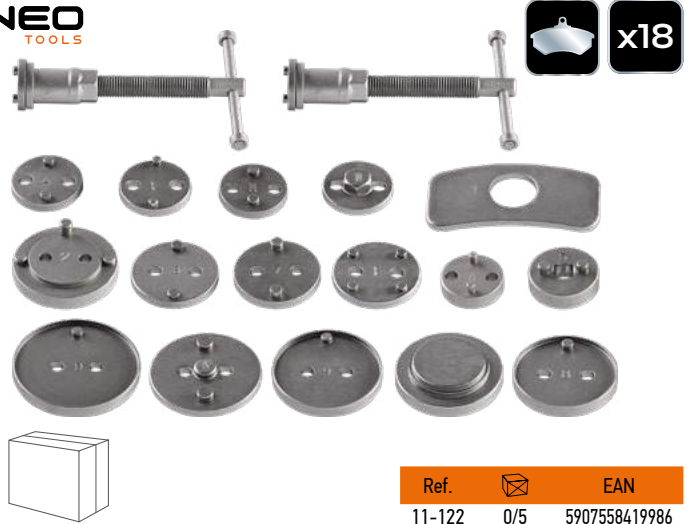

Ref.	☒	EAN
11-122	0/5	5907558419986

NEO
TOOLS



Ref.	☒	EAN
11-129	1/5	5907558437256

Separator pneumatyczny z końcówkami

Air brake caliper wing tool / Einstellwerkzeug für pneumatische Bremszylinder / Инструмент регулировки пневматического тормозного цилиндра / Инструмент регуливання пневматичного гальмівного цилиндра / Pneumatikus fékhenger beállító eszköz / Instrument de reglare a cilindrului de frână pneumatic / Nástroj pro seřízení pneumatického brzdového válce / Nástroj na nastavenie pneumatického brzdového valca / Orodje za nastavitvev pnevmatičnega zavornega valja / Pneumatinis stabdžių cilindro reguliavimo įrankis / Pnevmatisks bremžu cilindra regulēšanas rīks / Pneumatiline pidurisilindri reguleerimise tööriist / Пневматичен инструмент за регулиране на спирачния цилиндър / Alat za podešavanje pnevmatskog kočnog cilindra / Αλμαίο ρύθμισης κυλίνδρου πεπιεσμένου αέρα / Herramienta de ajuste del cilindro de freno neumático / Strumento di regolazione del cilindro del freno pneumatico / Ferramenta de ajuste de cilindro de freio pneumático / Outil de réglage du cylindre de frein pneumatique / Luchtremklauw vleugel gereedschap

NEO
TOOLS

16
ELEMENTS

L/R

1/4"



Ref.	📦	EAN
11-132	0/5	5907558445435

Ściernice do czyszczenia piast

Wheel hub grinder Schleifmittel zur Reinigung von Naben / Шлифовальные круги для очистки ступицы / Шліфувальні круги для очищення маточин / Kerékagy tisztító dörzstárcsa / Discuri pentru curățarea butucilor / Brusné kotouče pro čistění nábojů / Brusné kotúče na čistenie nábojov / Brusi za čiščenje pest / Įrankiai ratų stebulių valymui / Ritepa rumbas tūrišanas slīpdiski / Rataste puhastamise lihvkettad / Почистювачи четки за главци / Diskovi za čiščenje glavčine / Brusione ploče za čiščenje čvorišta / Τροχοί λείανσης για καθαρισμό πλίνθινς τροχού / Amoladora para limpiar cubos de ruedas / Dischi abrasivi per la pulizia di mozzi / Escovas circulares para limpeza de cubos de rodas / Meules pour nettoyage des moyeux / Wielnaaf grinder voor reiniging

NEO
TOOLS

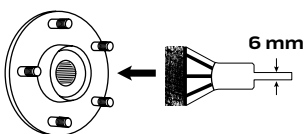
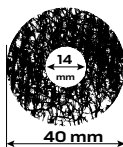

Ref.	📦	EAN
11-135	25/50	5907558437287

Zestaw do sprawdzania bicia tarcz hamulcowych

Brake disc run out kit / Prüfsatz für Unrundlauf von Brems Scheiben / Набор для проверки тормозных дисков / Набор для перевірки гальмівних дисків / Tárcsafék ütésmerő készlet / Trusă pentru verificarea bătăii discurilor de frână / Sada pro kontrolu brzdových kotoučů / Súprava na kontrolu brzdových kotúčov / Komplet za preverjanje zavornih diskov / Rinkiny stabdžių diskų patikrinimui / Bremžu disku pārbaudes instrumentu komplekts / Piduriketaste kontrollimise komplekt / Комплект за проверка на биемето на спирачните дискове / Set za proverju kočionih pločica / Pribor za proveru kočionih diskova / Σε ελέγχου δισκοφρένων / Kit para la comprobación de los discos de freno / Kit per il controllo dell'oscillazione assiale dei dischi freno / Kit de verificação de batimento dos discos de travão / Kit de mesure pour disques de freins / Remschijf opraken kit

±0,01
mm



NEO
TOOLS



Ref.	📦	EAN
11-130	1/10	5907558437263

Zestaw do montażu szczęk hamulcowych

Tool kit for brake shoe fitting / Bremsbacken-Montagewerkzeugsatz / Инструмент для обслуживания тормозной системы / Набор для монтажу гальмівних колодок / Fékprofaszerező készlet / Set pentru montarea sabotilor de frana / Sada na montáž brzdových čelistí / Súprava na montáž brzdových čelistí / Set za montažo zavornih čeljusti / Stabdžių trinkelų montavimo rinkinys / Bremžu uzliku turētāju montāžas komplekts / Piduriketaste paigaldamise komplekt / Комплект за монтирање на спирачните челюсти / Set za montažu kočionih čeljusti / Pribor za montažu kočionih čeljusti / Εργαλεία συντήρησης ουστημάτων πέδησης / Kit de montage de mordazas de frenos / Kit per montaggio pinze del freno / Jogo de ferramentas para montagem de maxilas de travão / Jeu d'outils de montage de mâchoire de frein / Set voor montage van remkaken

NEO
TOOLS



Ref.	📦	EAN
11-131	1/5	5907558437270

Klucz do kół

Wheel wrench / Radschlüssel / Ключ для колес / Ключ для монтажу кіл автомобільних / Kereszt kerékkulcs / Cheie piulită p/u demontarea și montarea roților / Klič na kola / Klič na kolesá teleskopický / Ključ za avtomobilsko kolesa / Raktas ratams / Riteņu atslēga / Rattavõti / Ключ за гуми / Ključ za kotač / Ključ za točak / Κλειδί για τροχούς / Llave extensible para ruedas / Chiave a croce / Chave para filtro / Clef pour filtre / Wielsleutel

NEO
TOOLS

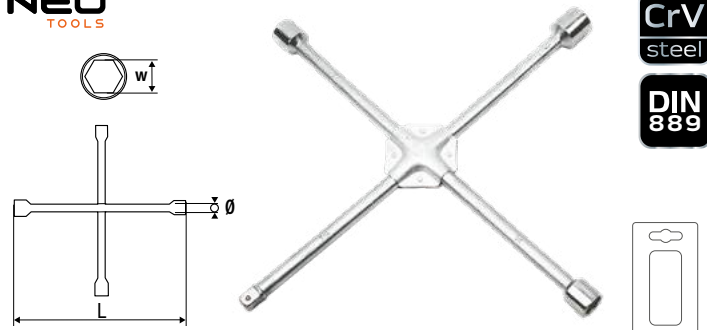

CrV
steel

DIN
889

Ref.	W	ø[mm]	L[mm]	⊠	EAN
11-100	17x19x22x1/2"	16	355	0/16	5907558412864

NEO
TOOLS

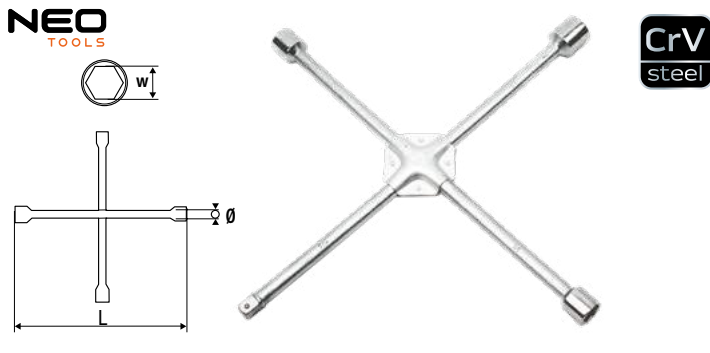

CrV
steel

Ref.	W	ø [mm]	L [mm]	⊠	EAN
11-102	24 x 27 x 32 mm, 3/4"	22	700	0/4	5907558418309

NEO
TOOLS



CrV
steel

1/2"

Ref.	W	⊠	EAN
11-101	17x19x1/2"	6/12	5907558417135

TOPEX



Ref.	W [mm]	L [mm]	⊠	EAN
37D305	17/19	340/520	0/24	5902062040671

TOPEX

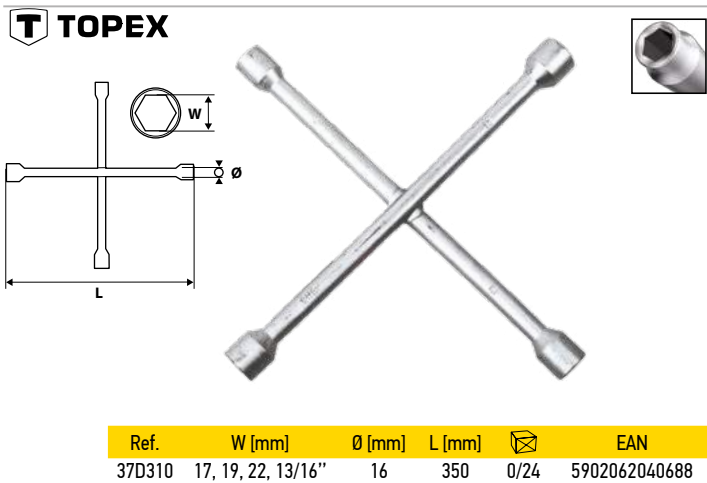

Ref.	W [mm]	Ø [mm]	L [mm]	⊠	EAN
37D310	17, 19, 22, 13/16"	16	350	0/24	5902062040688

TOPEX

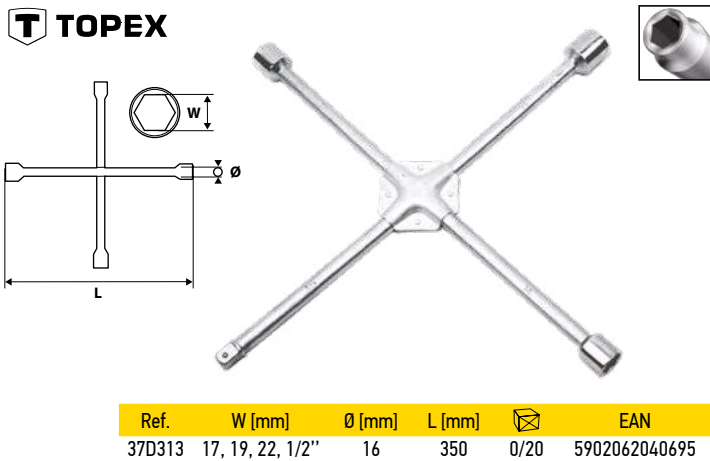

Ref.	W [mm]	Ø [mm]	L [mm]	⊠	EAN
37D313	17, 19, 22, 1/2"	16	350	0/20	5902062040695

Zestaw łomów

Go-through pry bar set / Brechstangen-set / Набор монтажек / Набор ломів / Feszítóvas készlet / Set de rângi de oțel / Sada pačidel / Súprava pačidel / Komplet lomik / Laužtuvų rinkinys / Laužtu komplekts / Kangide komplekt / Комплект щангу / Set poluga / Garnitura poluga / Σετ κουτάλες / Juego de palancas / Set di leve da sforzo / Kit de pés-de-cabra / Jeu de pieds-de-biche / Set van breekijzers

NEO
TOOLS

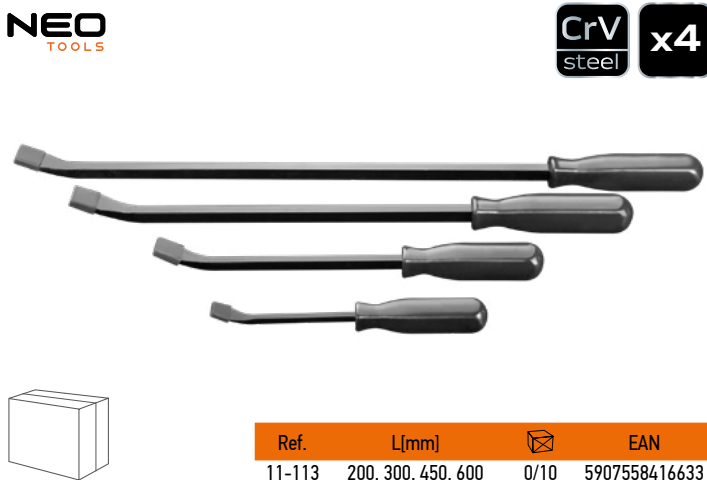

CrV
steel

x4

Ref.	L[mm]	⊠	EAN
11-113	200, 300, 450, 600	0/10	5907558416633

Łyżka do opon

Wrecking bar / Reifenlöffel / Монтажна автомобильная / Монтувалка / Gumiabroncs szerelővas / Levier pentru pneu / Montážní páka na pneumatiky / Páka na pneumatiky / Žlička za pneumatike / Svirts padangų montavimui / Lápstipa riepu montāžai / Rehvilusikas / Щанга за демонтаж на гуми / Podizač za montiranje guma / Kašika za gumu / Κουτάλα φανοποιίας / Llave cuchara para extraer ruedas / Leve per pneumatici / Ferramenta para rodas / Demonte-pneus / Breekijzer

NEO
TOOLS

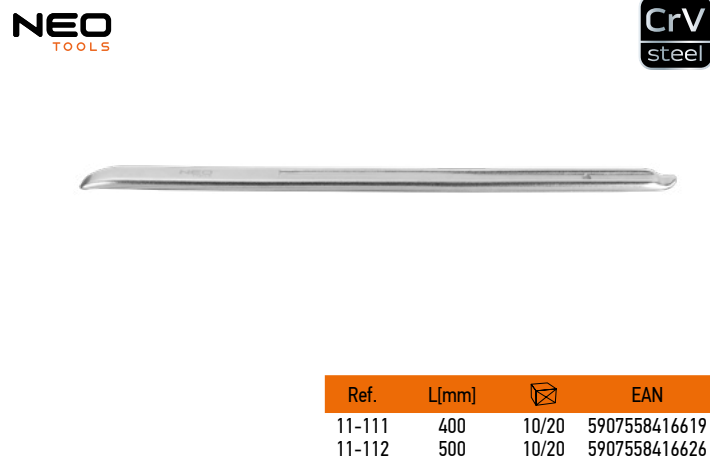

CrV
steel

Ref.	L[mm]	⊠	EAN
11-111	400	10/20	5907558416619
11-112	500	10/20	5907558416626

Nasadka do świec

Spark plug socket / Aufsatz für Zündkerzen / Головка сменная свечная / Ключої свічній / Gyertyakulcs / Cheie tubulara pentru bujii / Nástavec na svičky / Nástavec na svečice / Nasadni ključ za svečke / Galvutė žvakėms / Sveču atslēga / Küünlapadrun / Наставка за свеци / Карика за свјеџице / Nasadka za svećice / Kapuđaki za použi / Vaso para bujia / Chiave per candele / Bocal p. velas / Douille à bougie / Kaarsendop

NEO
TOOLS

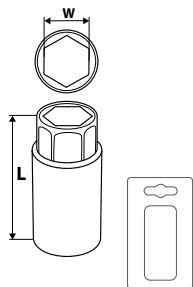

CrV
steel

1/2"

Ref.	W [mm]	L [mm]	⊠	EAN
08-090	16	65	24/144	5907558406092
08-091	21	68	24/96	5907558406252

T TOPEX

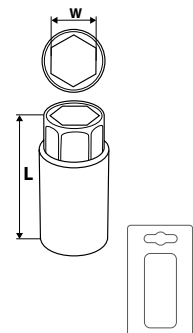

CrV 1/2"

Ref.	W [mm]	L [mm]	⊠	EAN
38D764	16	65	20/160	5902062387646
38D765	21	65	12/96	5902062387653

Klucz do świec

Spark plug wrench / Zündkerzenschlüssel / Ключої свічній / Ключ для свічок / Gyújtógyertyakulcs / Cheie luminare / Klič na svičky / Ključ sviečkový / Ključ za vžigalno svečko / Raktas degimo žvakėms / Svečatslēga / Süütekiünla võti / Ключ / Ключ / Ключ / Кλειδί για πουζι / Llave para bujia / Bussolle poligonali / Chave p. velas / Clef à bougie / Kaarsleutel

NEO
TOOLS

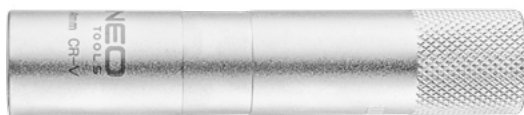

3/8"

Ref.	W [mm]	L [mm]	⊠	EAN
11-152	14	90	50/100	5907558417166
11-153	16	90	50/100	5907558417173

T TOPEX



CrV

Ref.	W [mm]	⊠	EAN
37D051	21	1/70	5902062370518
37D052	16	1/70	5902062370525

TOP TOOLS



Ref.	W [mm]	⊠	EAN
37D221	21	6/60	5902062040657
37D222	16	0/60	5902062040664

Szczypce do ściągnięcia przewodów zapłonowych

Spark plug wire boot pliers / Zange zum Abziehen von Zündkabeln / Плоскогубцы для снятия проводов зажигания / Плоскогубци для знімання опртові запалювання / Gyújtókábel lehúzó fogó / Clește pentru scoaterea cablurilor de aprindere / Kleště na kabely zapalovacích svíček / Kliešte na demontáž zapalovacích vodičov / Klešče za vtiče vžigalnih svečk / Replij rinkiņys, uzvedimo laidu nužēvinimui / Platknabiles aizdedzes vadu noņemšanai / Süütejuhtmete näpitsad / Клеци за кабели на свециме / Klijesta za skidanje žica za paljenja / Klješta za skidanje kablova svećica / Πένσα εξαγωγής μπουζοκαλωδίων / Alicates para quitar los cables de arranque / Pinze per lo scollamento dei cavi d'accensione / Alicates para extração de cabos de ignição / Pincas pour enlever les câbles batterie / Tangen voor bougie leidingen

NEO
TOOLS

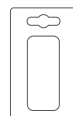
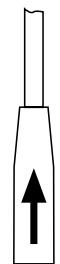

Ref.	⊠	EAN
11-165	5/20	5907558437294

Szczelinomierz

Feeler gauge / Schiebelehre / Шлн / Шлн / Hézagmérő készlet / Calibru măsurare grosime / Spároměr / Lístkové mierky / Kontrolni lističi / Ertmių matavimo prietaisas / Spraugmērs / Mõõtesond / Лыфтмомер / Kontrolni lističi / Kontrolni lističi / Διακενόμετρο / Calibre de espesores / Calibro a spessore / Medidor de folgas / Jauge d'épaisseur / Voelmaat

NEO
TOOLS

STAINLESS
steel 65
Mn



Ref.	Ra [mm]	N	⊠	EAN
11-190	0.04 - 0.63	26	20/120	5907558452433
11-191	0.05 - 1.0	20	20/120	5907558452440
11-192	0.127 - 0.508	16	20/120	5907558452457

T TOPEX

x20



Ref.	⊠	EAN
97X272	0/1	5902062170590

Ściągacze do sprężyn

Spring pullers / Abzieher für Feder / Съёмные приспособления для пружин / Знімачі пружин / Rugóösszehúzó kézi / Ancore de arcure / Stahovák pružin / Stahovák pružin / Izvlekači za vzmeti / Spyruoklių spaustai / Atsperu noņemama ierīce / Vedrutõmmitsad / Скобы за пружину / Skidači za opruge / Stega za oprugu / Εξωλέκας ελατηρίων / Extractor de muelles / Pressori per molle / Ponta de aperto para molas / Extracteurs de ressorts / Trekkers voor veren

NEO
TOOLS



Ref.	Ra[mm]	☒	EAN
11-796	23-280	1/5	5907558436747

NEO
TOOLS



125/212 mm, 88/160 mm, 65/125 mm.

BMW: E31 - E67, MINI R50/R52/R53, Fiat, Alfa Romeo, Chrysler, Lancia, Ford, Mazda, Honda, Hyundai, Jaguar, Jeep, Kia, Mercedes C/E, Citroen, Peugeot, Opel, Vauxhall, Saab, Renault, Nissan, Infiniti, Dacia, Mitsubishi, Rover, Subaru, Toyota, Audi, Porsche, Skoda, VW, Volvo

Ref.	☒	EAN
11-797	1/1	5907558436754

Ściągacz do koła kierownicy

Steering wheel puller / Abzieher für Lenkradsrad / Съёмное устройство рулевого колеса / Знімач керма / Kormánykerék leszedő készlet / Ancoră de volan / Stahovák volantu / Stahovák volantu / Izvlekač za volan / Vairo traukės nuėmklis / Stūres rata noņemama ierīce / Juhtratta tõmmits / Скоба за колелото на волана / Skidač kotača volana / Stega za upravljač / Εξωλέκας τιμονιού / Extractor de volante / Estrattore di volante / Ponta de aperto para volante / Extracteur de volant / Trekker voor stuurwiel

NEO
TOOLS



Ref.	☒	EAN
11-816	5/20	5907558419696

NEO
TOOLS



70-130
90-150
mm



70/130 mm, 90/150 mm
Mercedes

W123, W124, W126, W140, W202, W210

W107, W114, W115, W116, W123, W124, W126, W129, W140, W201, W202, W203

Opel / Vauxhall / Hyundai / Lada / Rover / Saab / Fiat / Ford / Mazda / Toyota / Nissan / Mitsubishi / Peugeot / Volo / VW

Ref.	Ra[mm]	☒	EAN
11-798	70-130; 90-150	1/2	5907558436761

NEO
TOOLS

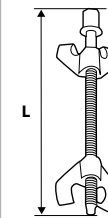

Ref.	L[mm]	☒	EAN
11-807	300	0/10	5907558418453

NEO
TOOLS

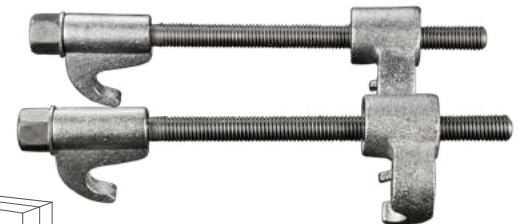
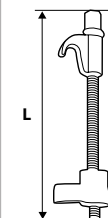

Ref.	L[mm]	☒	EAN
11-808	300	0/10	5907558418460

Dźwignia do przegubów

Lever for articulated joints / Hebel für Gelenke / Рычаг для шарниров / Важіль до шарнирів / Gömbfejserelő villa / Levier de articulation / Podpěra kloubů / Páka k čarom / Vítice za zglobne / Vyrių svirtis / Šarniru svira / Klambrikang / Лост за шарнири / Poluga za zglobove / Poluga za zglobove / Μοχλός μετεξέδων / Palanca para rótulas / Leva per giunti articolati / Alavanca p. Articulações / Levier pour articulations / Hefboom voor spilverbindingen

NEO
TOOLS

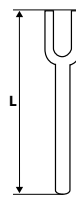

Ref.	L [mm]	☒	EAN
11-805	300	0/12	5907558418590
11-806	400	0/12	5907558418606

Ściągacz do przegubów

Ball joint puller / Gelenkabziehvorrichtung / Съёмник шарниров / Пристрій для зняття шарнірів / Gömbcsukló kinyomó / Extractor articulații sferice / Stahovák kloubů / Stahovák na gulavé čapy / Snemalec / Nuémiklis sarnyrams / Novilcējs / Kuullidestõmmits / Скоба за болтове / Izvlačáč / Radarciger / Кρικοπάλαυκα για καστανές / Extractor de juntas de rótula / Estrattore di giunti a sfera / Ponta de aperto de articulações / Arrache-articulations / Trekker voor spilverbindingen

NEO
TOOLS

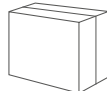
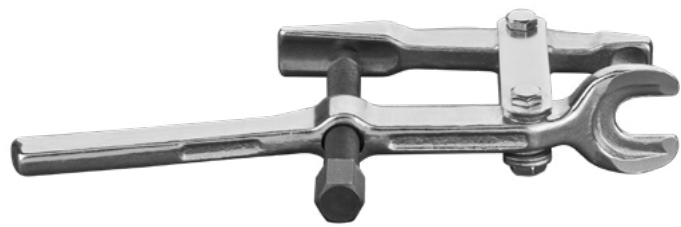

Ref.	ø [mm]	☒	EAN
11-801	20	0/20	5907558416527

NEO
TOOLS

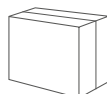
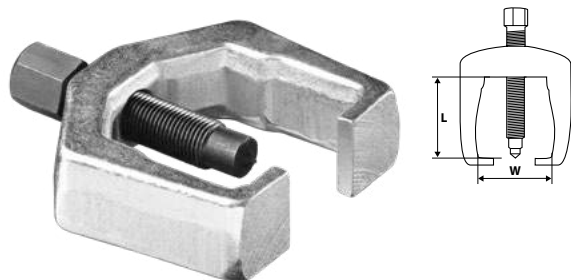

Ref.	L [mm]	W [mm]	☒	EAN
11-803	45	27	0/20	5907558418439
11-804	65	32	0/20	5907558418446

Zestaw ściągaczy do drążków kierowniczych

Steering rods puler set / Abziehvorrichtungssatz für Spurstangen / Набор съёмников шаровых опор и рулевых наконечников / Набор знімачів до кермових тяг / Kormányösszekató-gömbfejkinymó készlet / Set trágätoare bare de comandă / Sada stahováků táhel řízení / Sada stahovákův tiahiel riadenia / Set izvlekačev za krmilne drogove / Guolinių atramų ir vairo traukių nuėmimo rinkinys / Stūres uzgaļu un sfērisko balstu novilcēju komplekts / Roolivarda tõmmitsate komplekt / Комплект скобы за изваждане на нормилни щанги / Set skidača za upravljačke šipke / Pribor alatki za skidanje upravljačkog stalka / Set εξωλκέων σφαιρικών αρθρώσεων και κατευθυντήριων ραβδών / Juego de extractores de barras de dirección / Kit di estrattori per tiranti dello sterzo / Kit de extractores de barras de direção / Kit d'extracteurs de biellette de direction / Trekkers voor stuurstangen

NEO
TOOLS



Ref.	☒	EAN
11-799	1/2	5907558436778

NEO
TOOLS

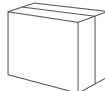
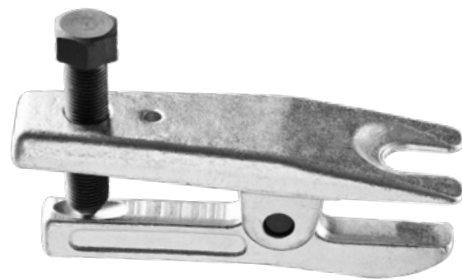

Ref.	ø [mm]	☒	EAN
11-802	19	0/20	5907558418422

TOPEX

CrV

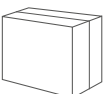
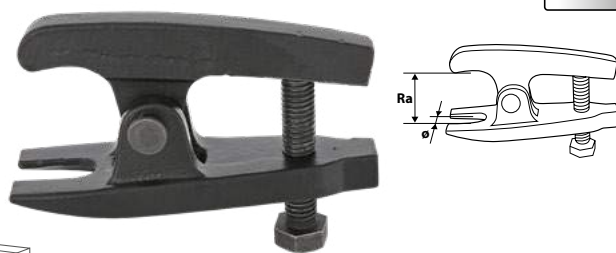

Ref.	Ra [mm]	ø [mm]	☒	EAN
37D410	45	15	5/20	5902062374103

Ściągacz z siłownikiem

Hydraulic puler / Abzieher mit Servoantrieb / Съёмник с гидроприводом / Знімач із гідроприводом / Lehúzó hidraulikus rásegítéssel / Extractor cu dispozitiv de acționare / Hydraulický stahovák / Stahovák so servomotorom / Hidravlični izvlečáč / Hidraulinis nutraukiklis / Novilcējs ar hidropiedziņu / Servomotoriga tõmmits / Инструмент за демонтаж с цилиндр / Skidač sa cilindrom / Alatka za skidanje sa hidraulikom / Υδραυλικός εξωλκέας / Extractor con accionador / Estrattore con cilindro / Extrator com acionador / Extracteur avec vérin / Hydraulische trekker

NEO
TOOLS

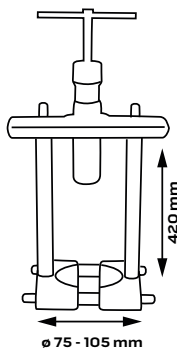

Ref.	☒	EAN
11-847	1/2	5907558436853

Ściągacz trójramienny

Three-arm puller / 3-Arm Abzieher / Съёмник с тремя захватами / Знімач тріплечеви / Csapágyelhúzó, háromkörmös / Extractor cu trei brațe / Трёхручійний стahовák / Trojramenný stahovač / Trokraki snemalec / Trižiaunis nutraukklis / Trīsplecu novilcējs / Kolmeharuline tõmmits / Трёхручійна скоба / Trokraki izvlakač / Trokraki alat za skidanje / Εξολκείας με τρεις σιαγόνες / Extractor de tres brazos / Estrattore a tre griffe / Extrator de três braços / Arrache à trois branches / Driearmige trekker

NEO
TOOLS

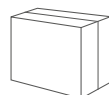
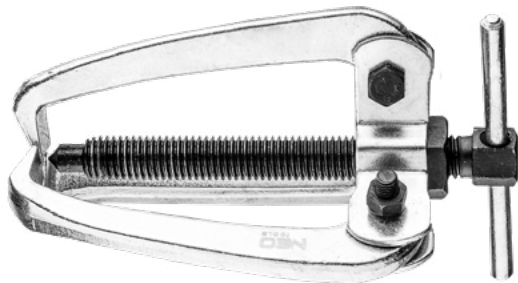

Ref.	L[mm]	☒	EAN
11-868	25	0/50	5907558420128
11-869	50	0/50	5907558420135
11-870	75	0/50	5907558420142

NEO
TOOLS

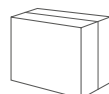

Ref.	L[mm]	☒	EAN
11-857	150	0/16	5907558416862
11-858	200	0/6	5907558416879
11-859	300	0/2	5907558416886

NEO
TOOLS

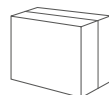

Ref.	L[mm]	☒	EAN
11-861	100	0/20	5907558416794
11-862	150	0/10	5907558416800

T TOPEX

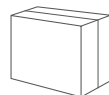

Ref.	Ø [mm]	L [mm]	☒	EAN
37D405	75	50	0/30	5902062040770
37D406	100	55	0/20	5902062040787

Ściągacz dwuramienny

2 jaws puller / Abzieher mit zwei schenkeln / Съёмник подшипников 2-х лапчатый / Знімач двоплечеви / Csapágyelhúzó, kétkörmös / Extractor cu două brațe / Stahovák dvouramenný / Dvojramenný stahovák / Dvokraki snemalec / Nuēmējas, divšakis / Divplecu novilcējs / Kaheharuline tõmmits / Двухручійна скоба / Dvostruki odvajač / Dvokraka stega / Εξολκείας έναρριων τριβέων με 2 σιαγόνες / Extractor de dos brazos / Estrattore a due griffe / Sacador de 2 garras / Extracteur a 2 bras / Tweearmige trekker

NEO
TOOLS

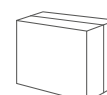

Ref.	L[mm]	☒	EAN
11-871	25	25/100	5907558420159
11-872	50	25/100	5907558420166
11-873	75	25/50	5907558420173

NEO
TOOLS

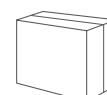

Ref.	L[mm]	☒	EAN
11-850	75	0/50	5907558416817
11-851	100	0/50	5907558416824
11-852	150	0/50	5907558416831

NEO
TOOLS

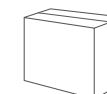
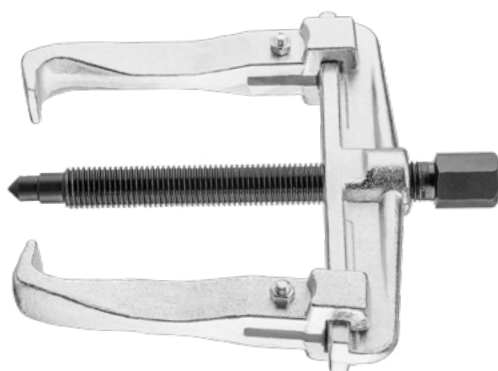

Ref.	L[mm]	☒	EAN
11-865	100	0/16	5907558418514
11-866	110	0/12	5907558418521
11-867	140	0/12	5907558418538

Ściągacz do ramion wycieraczek

Wiper arm puller / Abzieher für Scheibenwischer / Съёмник рычагов стеклоочистителя / Знімач важелів склоочисників / Ablaktör für Kar lehúzó / Dispositiv de scos de brate de stergător de parbriz / Stahovák na ramínka stěračů / Stahovač na demontáž ramienok stieračov / Snemalec za brisalce / Valytuvu kotu nuēmiklis / Stikla tīrītāju plecu novilcējs / Kojamehe hoobade tõmmits / Скоба за ramo на чистачката / Alat za skidanje brizgaljki / Alat za skidanje ramena brisača / Εξολκείας μοχλών υαλοκαθαριστήρα / Extractor de brazos de limpiaparabrisas / estrattore per braccio del tergicristallo / Extrator de limpa para-brisas / Extracteur de bras d'essuie-glaces / Trekker voor ruitenwisserarmen

NEO
TOOLS

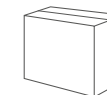

Ref.	☒	EAN
11-827	0/120	5907558420067

Ściągacz dwuramienny i separator

Gear puller set / Abzieher mit zwei schenkeln und ausscheider / Съёмник универсальный с сепаратором / Знімач двооплечевий і сепаратор / Csapágylehúzó készlet / Extractor universal cu două brațe și separator / Sada dvouramenný stahovák a oddělovač / Súprava dvojamenný stahovák a separátor / Komplet dvokrakega snemalca in ločilnika / Dvišakių nuėmėjų rinkinys su separatorium / Diplecu novilceja un separatora kompleks / Kaheharuline tõmmits ja sepaator / Комплект двураменна стяга със сепаратор / Set dvokraki skidač i separator / Garnitura dvokraka stega i separator / Εξολκείας γενικής χρήσης με διαχωριστή / Juego de extractores de dos brazos y separador / Set separatore per cambio / Kit sacador de 2 garras e separador / Jeu d'extracteurs a 2 bras et separateur / Tweearmig trekker en separator

NEO
TOOLS



Ref.	📦	EAN
11-810	0/4	5907558416572

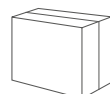

Ściągacz do piast

Wheel hub puller / Abzieher für Radnaben / Съёмное приспособление для ступицы / Знімач маточин / Kerékagy lehúzó készlet / Ancoră de butuc / Stahovák hlavy kola / Stahovák náboja / Izvlekač za pesta / Stebulių spaustai / Rumbu noņemama ierīce / Rattarummu tõmmits / Скоба за втулку / Skidač za glavčine / Stega za glavčino / Εξολκείας πλήμνης / Extractor de cubos de ruedas / Estrattore a bilanciere / Ponta de aperto / Extracteur de moyeux / Trekker voor naaf

NEO
TOOLS



Ref.	📦	EAN
11-811	5/20	5907558418484

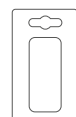

Zestaw do demontażu poduszek powietrznych

Airbag removal tool set / Abbausatz für Luftkissen / Набор для замены подушки безопасности / Набор для заміни подушок безпеки / Légzsák kiszerező készlet / Set pentru scoaterea airbag-urilor / Sada na demontáž airbagů / Súprava na demontáž airbagov / Set za odstranitev zračnih blazin / Oro paagalvių išmontavimo rinkinys / Drošības spilvena noņemšanas instrumentu komplekts / ðhkrpatjade eemaldamise komplekt / Комплект за демонтаж на въздушни възглавници / Set za skidanje zračnih jastuka / Pribor za demontiranje vazdušnih jastuka / Σετ αντικατάστασης αερόσακου / Kit de desmontaje de airbags / Kit per lo smontaggio di airbag / Kit de ferramentas de desmontagem de airbags / Kit de démontage des airbags / Set voor demontage van airbags

NEO
TOOLS



Ref.	📦	EAN
11-817	1/10	5907558436785

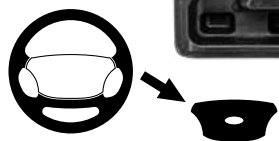

Ściągacz do łożysk

Gear puller / Lagerabziehvorrichtung / Съёмник подшипников / Пристрій для зняття підшипників / Csapágylehúzó / Extractor elicoidal / Stahovák ložísek / Stahovák dvojamenný / Snemalec / Guolių nuėmėklis / Novilcējs gultņiem / Hammarratta tõmmits / Скоба за лезеру / Izvlekač / Radarciger / Κρικοπάλαγο για άξονες τριβής / Extractor de cojinetes / Estrattore rapporti / Ponta de aperto para rolamentos / Arrache-roulements / Lageronderbank

NEO
TOOLS

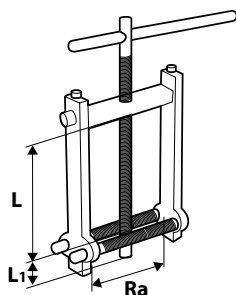

Ref.	L [mm]	L ₁ [mm]	Ra [mm]	📦	EAN
11-813	100	20	24 - 55	0/30	5907558418507

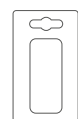

NEO
TOOLS



Ref.	Ra [mm]	📦	EAN
11-848	35-130	1/2	5907558436860

NEO
TOOLS

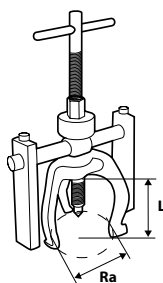

Ref.	L [mm]	Ra [mm]	📦	EAN
11-812	70	18 - 43	0/20	5907558418491

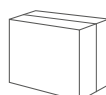

Zestaw do ściągania i instalowania łożysk

Bearing removal and fitting kit / Radlager-Werkzeug-Satz / Набор для снятия/установки подшипников / Хабір для знімання та встановлення вальниць / Csapágszerező szerszámkészlet / Set de dispozitive de scos si de instalat lagare / Sada pro výtěnu a montáž ložisek / Súprava na demontáž a inštaláciu ložísk / Set za snemanje in montažo ležajev / Guolių montavimo komplektas / Gultņņu novilkšanas un instalēšanas komplekts / Laagrite eemaldamise ja paigaldamise komplekt / Комплект за стягане и инсталлиране на лагери / Set za skidanje i instaliranje ležaja / Pribor za skidanje i instaliranje ležišta / Σετ αποβίβασης/αφαιρέσεως τριβέων / Juego para extraer e instalar rodamientos / Kit estrazione e montaggio cuscinetti / Jogo de ferramentas para remover e instalar rolamentos / Jeu d'arrache-roulement et de monte-roulement / Set voor demontage en installatie van lagers

NEO
TOOLS



50-88
mm

Ref.	Ø [mm]	📦	EAN
11-690	50, 55, 60, 64, 67, 70, 72, 74, 75, 78, 82, 84, 88	1/2	5907558436624

NEO
TOOLS



18-65
mm

Ref.	Ø [mm]	📦	EAN
11-691	18, 19, 20, 21, 22, 23, 24, 25, 26, 27, 28, 29, 30, 31, 32, 33, 34, 35, 36, 37, 38, 39, 40, 41, 42, 43, 44, 45, 46, 47, 48, 49, 50, 51, 52, 53, 54, 55, 56, 57, 58, 59, 60, 61, 62, 63, 64, 65	1/1	5907558436631

Przecinaki do nakrętek

Nut splitters / Meißel für Mutter / Γαϊνολομύς / Розривач до мутр / Csavaranyágók / Dălți pentru piulițe / Trháč matic / Trhače matic / Lomilci matic / Veržliči kirstukai / Uzgriežņi cirtņi / Meislid / Сеначи за гайки / Rezač za matice / Sekač navrtanja / Κόφτες παξιμαδιών / Tajadera de tuercas / Spaccadadi / Cortadores de porcas / Burins à écrous / Moerknippers

NEO
TOOLS



oczko 9 - 12 mm / klucz 12 mm
9 - 12 mm nut splitter. Spaner drive shaft 12 mm
размер гайки 9 - 12 мм / ключ 12 мм
oczko 12 - 16 mm / klucz 14 mm
12 - 16 mm nut splitter. Spaner drive shaft 14 mm
размер гайки 12 - 16 мм / ключ 14 мм
oczko 16 - 22 mm / klucz 19 mm
16 - 22 mm nut splitter. Spaner drive shaft 19 mm
размер гайки 16 - 22 мм / ключ 19 мм
oczko 22 - 27 mm / klucz 21 mm
22 - 27 mm nut splitter. Spaner drive shaft 21 mm
размер гайки 22 - 27 мм / ключ 21 мм

Ref.	📦	EAN
11-925	0/10	5907558436945

Zestaw nasadek

Socket set / Aufsatzset / Набор головок торцевых / Хабір насадок торцевих / Törtcsavarkihajtó készlet / Set duze / Sada násadek / Súprava nástr. klúčov / Garnitura nasadnih ključev / Antgalių rinkinys / Мисциу комплекts / Padruni komplekt / Геодре номн / Šesterokutne kapice / Gedora set / Συλλογή καρυκακιών / Llaves de vaso / Set di boccole / Kit de bicos / Jeu de douilles / Set van doppen

NEO
TOOLS

x16 1/2"



8, 10, 11, 12, 13, 14, 15, 16, 17, 19, 21, 22, 24, 27 mm
2 wybijaki do usuwania śrub z nasadek
2 x punches
2 выколотки для снятия винтов с головок
Można stosować z kluczami udarowymi
Suitable for impact wrenches
Можно использовать с ударными гаечковертами
Wewnętrzna spirala powoduje samoczynne zaciskanie się na uszkodzonej śrubie/nakrętce umożliwiając bezpieczne odkręcenie
The innovative spiral profile digs itself into the head of a damaged screw/nut and thereby allows to loosen it securely
Внутренняя спираль вызывает автоматическое зажатие поврежденного болта/гайки, обеспечивая безопасное откручивание

Ref.	📦	EAN
11-920	0/10	5907558436914

NEO
TOOLS

x11 3/8"



9, 10, 11, 12, 13, 14, 15, 16, 17, 19 mm
przetyczka 1 szt.
1 x punches
1 x штырь
Wewnętrzna spirala powoduje samoczynne zaciskanie się na uszkodzonej śrubie/nakrętce umożliwiając bezpieczne odkręcenie
The innovative spiral profile digs itself into the head of a damaged screw/nut and thereby allows to loosen it securely
Внутренняя спираль вызывает автоматическое зажатие поврежденного болта/гайки, обеспечивая безопасное откручивание

Ref.	📦	EAN
11-922	0/20	5907558436938

Indukcyjna grzałka do śrub

Induction bolt and screw heater / Induktives Heizgerät für Schrauben / Индукционный нагреватель / Нагревач индукційний / Indukciós hevítő készlet / Incalzător cu inducție pentru șuruburi / Indukční ohřev šroubů / Indukčný ohrievač pre skrutky / Indukcijski grelnik za vijake / Indukcinis šildytuvas varžtams / Indukcijas silātājs / Induktsioon-põldisoojendi / Индукционен нагревател за болтове / Indukcijski grijač za vijake / Indukcioni grejač za šrafove / Επαγωγικός θερμαντήρας / Calentador de inducción para tornillos / Riscaldatore ed induzione per viti / Aquecedor de indução para parafusos / Pistolet à chaleur inductive pour vis / Inductie dampelaar voor schroeven

NEO
TOOLS



700°C 1200W

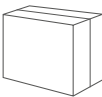

Ref.	☒	EAN
11-931	0/1	5907558436969

Zestaw do naprawy gwintów

Thread repairing kit / Gewindereparatursatz / Набор для восстановления резьбы / Набор для відновлення гвинтованих з'єднань / Menejavitő készlet / Set de rectificat fileturi / Sada pro opravu závitů / Súprava na opravu závitov / Set za popravilo navojev / Sriegimo įrankių rinkinys / Skrivju remontkomplekts / Keerteraparanduskomplekt / Комплект за ремонт на резьба / Set za popravak navoja / Pribor za popravku šrafova / Σετ αποκατάστασης σπειρωμάτων μ5 / Juego de reparación de tornillos / Kit riparazione filetti / Jogo de ferramentas para reparacão de roscas / Kit de réparation de taraudages / Schroefdraad herstelset

NEO
TOOLS



CrV
steel

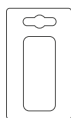

Ref.	Ø	☒	EAN
11-901	M6	10/40	5907558419870
11-902	M8	10/40	5907558419887
11-903	M10	10/40	5907558419894
11-904	M12	10/40	5907558419900

Wkłady do naprawy gwintów

Thread repairing kit / Gewindereparatureinsätze / Набор резьбовых вставок / Набор для відновлення гвинтованих з'єднань / Menejavitő betét / Adasuri de rectificat fileturi / Vložky pro opravu závitů / Vložky na opravu závitov / Set za popravilo navojev / Sriegimo galvučių rinkinys / Leiktnji vitņu remontam / Keerteraparandustüüblik / Элементы за ремонт на резьба / Umeci za popravak navoja / Umetak za popravku / Σετ ένθετα σπειρωμάτων / Repuestos para reparación de tornillos / Kit riparazione filetti / Cartuxos para reparacão de roscas / Inserts de réparation de taraudages / Inzetdelen voor schroefdraad herstel

NEO
TOOLS



Ref.	Ø	N	☒	EAN
11-905	M5	20	50/250	5907558419917
11-906	M6	20	50/250	5907558419924
11-907	M8	20	50/250	5907558419931
11-908	M10	20	50/250	5907558419948
11-909	M12	10	50/250	5907558419955

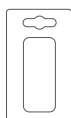

Narzynki i gwintowniki

Tap and die set / Schneideisen und Gewindebohrer / Плашки и метчики / Позначники й плашки, набір / Menetkészítő készlet / Set scule tăiere filet interior și exterior / Závítnice a závitníky / Súprava závitníkov / Garnitura vreznikov in nareznikov navoja / Sriegipjovės ir sriegikliai / Vitņgriežu komplekts / Kraani ja valuvormi komplekt / Метчици и плашки / Nareznice i ureznice set / Set ureznika i nareznika / Ελικοκόφτες και κολαούζα / Cojinetes y machos de roscar, juego / Madreviti e maschi / Cassonetes e roscas / Filières et tarauds / Snijplaat en schroefdraad snijtoestel

NEO
TOOLS

x110



Ref.	☒	EAN
11-915	1/3	5907558436907

TOPEX

WOLFRAM



x20

DIN
352

DIN
223

Ref.	Ø [nr]	☒	EAN
14A425	M3-M12	10/20	5902062544186

TOPEX

WOLFRAM



x32

DIN
352

DIN
223

Ref.	Ø [nr]	☒	EAN
14A426	M3-M12	0/16	5902062062024

Gwintowniki

Taps / Gewindebohrer / Метчики / Мітчики / Menetfúró készlet / Tarozí / Závıtnıky / Závıtnıky / Vrezniki navoja / Sriegtuvai / Vıthurbıs / Keermepuırd / Метцици / Alati za rezanje navoja / Narezna svrdla / Ξυλοράγος διάνοιξης απειρωμάτων / Machos de roscar / Filetti / Machos / Tarauds / Draadsnijtappen

TOPEX



x21

DIN 352

Ref.	Ø [nr]	⊠	EAN
14A430	M3 - M12	0/20	5902062062031

TOPEX



DIN 352



Ref.	Ø	⊠	EAN
14A203	M3	0/200	5902062060662
14A204	M4	0/200	5902062060679
14A205	M5	0/200	5902062060686
14A206	M6	0/200	5902062060693
14A208	M8	0/160	5902062060709
14A210	M10	0/100	5902062060716
14A212	M12	0/120	5902062060723

Pokrętko do gwintowników

Handle for hand tap / Gewindebohrergrıff / Вороток для метчиков / Вороток для позначника / Menetfúró hajtóvas / Manivelă burghiu manual / Vratidlo k závıtnıkům / Vratidlo na závıtnıky / Ročaj za vreznike navoja / Rankena sriegiklams / Vıthgrieža turétajs / Kásikraani käepide / Върток за метчик / Držač Ureznica / Okretac ureznika / Χειρολαβή για κολαούζο / Manivela para machos de roscar / Impugnatura per filetto / Chave para machos / Tourne-à-gauche / Draaiknop voor draadtap

TOPEX



Ref.	L [mm]	⊠	EAN
14A410	215	0/100	5902062060792

Narzynka

Die / Schneideisen / Плашка / Плашка / Menetmetsző / Filieră / Závıtová čelist / Závıtové očko / Narezniki navoja / Sriegpıovė / Vıthgriezis / Valuvorm / Плашка / Nareznica / Nareznica / Ελκοκόπηξ / Cojnete de roscar / Filetatrice / Cassonete / Filière / Snijplaat

TOPEX



DIN 233

Ref.	Ø [nr]	⊠	EAN
14A306	M6 [25x9mm]	0/200	5902062060839
14A308	M8 [25x9mm]	10/0200	5902062060846
14A310	M10 [25x9mm]	0/200	5902062060853
14A312	M12 [25x9mm]	0/200	5902062060860

Oprawka do narzynek

Handle for die / Schneideisenfassung / Вороток для плашек / Вороток для плашки / Menetmetsző hajtóvas / Miner filieră / Objımka závıtnic / Vratidlo na očká / Ročaj za nareznike navoja / Sriegpıovės rėmas / Vıthgrieža turétajs / Valuvormi käepide / Върток за плашка / Držač nareznica / Okretac nareznika / Χειρολαβή για ελκοκόπηξ / Terraaja de cojnetes / Impugnatura per filetatrice / Armadura p. Cassonetes / Monture de filière / Kader voor snijplaten

TOPEX



Ref.	L [mm]	⊠	EAN
14A420	230	0/100	5902062060587

Opaska ślimakowa

Hose clamp / Schneckenschelle / Хомут червячный / Хомут гвинтований / Tömlöbilincs / Brıtaıu cu melc / Šneková spona / Stahovacia páska kovová / Objemka na polža / Sqvarža / Gliemežsavilcėjs / Toruklamber / Скоба с червячна резба / Обујимка са рıжним навојем / Šelna / Οδοντωτός σφιγκτήρας σωλήνα / Bridas / Fascetta a vite / Abraçadeira caracol / Collier de serrage

NEO TOOLS



STAINLESS steel

W4

Ref.	Ø [mm]	N	⊠	EAN
11-400	8-12 / 9 mm	x3	0/200	5907558420425
11-401	10-16 / 9 mm	x3	0/200	5907558420432
11-402	12-20 / 9 mm	x3	0/200	5907558420449
11-403	16-27 / 9 mm	x3	0/200	5907558420456
11-404	20-32 / 9 mm	x3	0/200	5907558420463

TOPEX

W2



Ref.	Ø [mm]	H [mm]	⊠	EAN
37D501	8-12	9	0/1000	5902062375018
37D502	10-16	9	0/1000	5902062375025
37D503	12-20	9	0/1000	5902062375032
37D504	16-25	9	0/1000	5902062375049
37D505	20-32	9	0/1000	5902062375056
37D506	25-40	9	0/500	5902062375063
37D507	32-50	9	0/500	5902062375070
37D508	40-60	9	50/500	5902062375087
37D509	50-70	9	0/500	5902062375094
37D510	60-80	9	50/500	5902062375100
37D511	70-90	9	0/250	5902062375117
37D512	80-100	9	0/250	5902062375124
37D513	90-110	9	0/250	5902062375131
37D514	100-120	9	25/250	5902062375148
37D515	110-130	9	25/250	5902062375155
37D516	120-140	9	0/250	5902062375162
37D517	130-150	9	0/250	5902062375179
37D518	140-160	9	0/250	5902062375186

Szczypce do klipsów

Trim clip removal pliers / Trimmzange zum Entfernen des Clips / Плоскогубцы для удаления клипсы / Плоскогубцы для удаления клипсы / Vágókarpos-eltávolító fogók / Cliesti pentru scoaterea clemelor / Kleště na odstranění klipů / Klešte na odstraňovanie spôn / Klešče za odstranjevanje sponk / Sqvaržų šalinimo replės / Klipu noņemšanas knaibles / Klambrite eemaldamise tangid / Клеци за премахане на клип / Klješta za uklanjnje isječka / Къешта за укланяње клипа / Πένσα αφαίρεσης κλιπ / Recorte alicates de extracción de clip / Pinza per tagliare clip / Alicates de remoção de cliques de acabamento / Pince pour enlever les clips / Tang voor verwijderen van clip /

NEO TOOLS



25 years GUARANTEE

35x35 mm

Ref.	⊠	EAN
11-030	6/36	5907558445527

Zestaw ściągaczy do tapicerki

Upholstery puller set / Lösehebel-Satz für Polster / Набор съёмников панелей облицовки / Набор знімачів до обивки салону / Kárpíteszedő készlet / Set de scos piése de tapiserie / Sada pro demontáž čalounění / Súprava na demontáž čalúnenia / Set smetalcev oblazinjenja / Tvirtinimo elementu ištvaukikliu / Tapsėjuma novilcėju / Polstriřommitsate / Комплект скюбу за мануцериу / Set za skidanje tapicerung / Pribor alata za skidanje tapetarskog materijala / Σετ εξολκείς πλακών επένδυσης / Juego de extractores de tapizado / Serie di utensili per interni / Conjunto de extractores para tapeçaria / Jeu d'extracteurs de tapisserie / Set van trekkers voor stoffering

NEO
TOOLS



Ref.	☒	EAN
11-825	6/12	5907558436808

NEO
TOOLS



NYLON

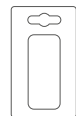

Ref.	N	☒	EAN
11-822	x5	6/24	5907558420029
11-823	x6	6/24	5907558420036
11-824	x11	0/10	5907558420043

Zestaw spinek samochodowych

Car pins / Auto-Körper-Clipsset / Клипсы крепления обивки / Набор кліпс кріплення обивки / Gépkocsi rögzítő patent készlet / Set de clipuri auto / Sada přichytek čalounění / Súprava sponiek do auta / Set avtomobilskih sponk / Avtomobilnių tvirtinimo elementų rinkinys / Арşuvuma stiprinājumi komplekts / Autotihvide komplekt / Комплект автомобильни щипки / Set spona za vozila / Komplet spojnice za automobile / Клипс тапетаріаіс / Kit de remaches de coche / Set di clip per carrozzeria / Luvas de nitrilo laranja / Ensemble d'épingles auto / Auto pinnen

NEO
TOOLS



x300

OPEL

Ref.	☒	EAN
11-952	0/28	5907558436990

NEO
TOOLS



x345

PEUGEOT

Ref.	☒	EAN
11-953	0/28	5907558437003

NEO
TOOLS



x408

HONDA

Ref.	☒	EAN
11-956	0/28	5907558437034

NEO
TOOLS



x415

MITSUBISHI

Ref.	☒	EAN
11-960	0/28	5907558437072

NEO
TOOLS



x290

BMW

Ref.	☒	EAN
11-961	0/28	5907558437089

NEO
TOOLS



x360

TOYOTA
LEXUS

Ref.	☒	EAN
11-950	0/28	5907558436976

Zestaw spinek samochodowych

Car pins / Auto-Körper-Clipsset / Κλιπсы крепления обшивки / Набор клипс кріплення обшивки / Gépkocsi rögzítő készlet / Set de clipuri auto / Sada přichytek čalounění / Súprava sponiek do auta / Set automobilskih sponk / Automobilių tvirtinimo elementų rinkinys / Арşuvuma stıprınājumi komplekts / Autotivtīde komplekt / Комплект автомобильни щипки / Set spona za vozila / Komplet spojnice za automobile / Κλιπς ταπεσαρίας / Kit de remaches de coche / Set di clip per carrozzeria / Luvas de nitrito laranja / Ensemble d'épingles auto / Auto pinnen

NEO
TOOLS

x255

VOLKSWAGEN



Ref.	☒	EAN
11-963	0/28	5907558437102

Nakrętki samohamowne

Self-locking nuts / Selbstsichernde Muttern / Самоконтрящиеся гайки / Гайки самоконтряючі / Őnzáró anyák / Piulițe cu auto-blocare / Samosvorné matice / Samosvorné matice / Samozaporne matice / Savaitme užsifiksuojaiančios veržlės / Pašbremzėjošie uzgriežni / Iseblokeeruvad mutrid / Самозаконтряци гайки / Samokočive matice / Samokočne matice / Παξιμάδια αυτοσφαλίζόμενα / Tuercas autoblocantes / Dadi autobloccanti / Porcas autotravantes / Écrous freins / Zelfverschuilende moeren

NEO
TOOLS

x146



Ref.	Ø [nr]	☒	EAN
11-972	M4 - M12	0/20	5907558437140

Podkładki miedziane

Coper pads / Unterlegscheiben aus Kupfer / Мідные шайбы / Шайби мідні / Réz alátétek / Şaibe de cupru / Měděné podložky / Medené podložky / Medeninaste podložke / Varinēs tarpinēs / Vara starplikas / Vasest seibid / Мідни шайби / Mesingasti podložci / Bakarne podložke / Χάλκινες ροδέλες / Arandelas de cobre / Rondelle in rame / Anéis de cobre / Rondelles en cuivre / Roestvrije onderringen

NEO
TOOLS

x300

CU



Ref.	☒	EAN
11-971	0/10	5907558437133

NEO
TOOLS

x150



Ref.	☒	EAN
11-979	0/20	5907558435740

Nity

Rivets / Niete / Закленки / Закленки / Alu popszegecs készlet / Nituri / Njity / Nity / Zakovice / Kniedēs / Kniedēs / Needitangid / Нитоее / Zakovice / Nitna / Πριτσίνια / Remaches / Rivetti / Rebites / Rivets / Klinknagels /

NEO
TOOLS

AL x400



Ref.	Ø [mm]	☒	EAN
11-970	2.4, 3.2, 4.0, 4.8	0/20	5907558437126

Sprężyny

Springs / Federn / Пружини / Пружини / Rugó készlet / Arcuri / Pružiny / Pružiny / Vzmeti / Spyruoklių rinkinys / Atsperes / Vedrud / Пружини / Opruge / Opruge / Σετ ελατήρια / Espirales / Molle / Molas / Ressorts / Veren

NEO
TOOLS

x200



Ref.	☒	EAN
11-980	0/20	5907558435757

Opaski zaciskowe

Band clips / Klemmschellen / Хомуты стяжные / Хомуты стяжні / Csőbilincs készlet / Cleme conexiune / Hadicové pásky / Fixačné pásky / PVC vezice / Užspauďejas / Savilceji / Rihmaklamber / Кабелин превръзки / Stezne trake / Pvc vezice / Καλλάρια αύσιφής / Bridas / Fasce con morsetto / Cintas p. gramppear / Bride de serrage / Klembanden

NEO
TOOLS

x34



Ref.	☒	EAN
11-981	0/20	5907558435764

Uszczelki (O-ring NBR)

Seals (O-ring NBR) / Dichtungen (O-ring NBR) / Прокладки (O-ring NBR) / Прокладки (O-ring NBR) / Tömítés készlet (o-gyűrű nbr) / Garnituri (O-ring NBR) / Těsnění (O-ring NBR) / Tesnenia (O-ring NBR) / Tesnila (O-ring NBR) / Tarpinės (O-ring NBR) / Blīves (O-ring NBR) / Tihendid (O-ring NBR) / Гарнитурa (O-ring NBR) / Brtvila (O-ring NBR) / Zaptvike (O-ring NBR) / Ταμώρες (O-ring NBR) / Juntas de calafateo (O-ring NBR) / Guarnizioni (O-ring NBR) / Vedantes (O-ring NBR) / Joints (O-ring NBR) / Dichtringen (O-ring NBR)

NEO
TOOLS

x225



Ref.	☒	EAN
11-977	0/20	5907558437195

Koszulki termokurczliwe

Heat shrink sleeves / Wärmeschrumpfende Hüllen / Термоусадочные рукава / Рукави термоусадочні / Zsugorcső készlet / Manşoane termocontractabile / Teplom smrštitelné rukávy / Teplom zmrštitelné návleky / Toplotno-skrčene spojke / Termiškaiki susitraukiančios rankovės / Termoručigas uznavas / Termokahanevad särgid / Термосушсаемае шлагух / Termo savitljivi rukavi / Rukavi koji se skupljaju na toploti / Θερμοσυστέλλόμενα μονωτικά καλωδίων / Mangas termoencogibles / Guaine termorestringenti / Mangas termoretráteis / Gaines thermorétractables / Thermokrimp mouwen

NEO
TOOLS

x127



Ref.	☒	EAN
11-978	0/20	5907558437201

Korki z uszczelkami miedzianymi

Drain plugs and coper pads / Verschlusschrauben mit Kupferdichtungen / Набор медных прокладок и пробок / Набор мідних прокладок і корків / Menetes dugó és rézalátét készlet / Buşoane cu garnituri din cupru / Zátky s měděným těsněním / Zátky s medenými tesneniami / Čepi za medeninastimi tesnili / Variniai kamščiai ir tarpinės / Vāciņi ar vara starplikām / Vasktindhendega korgid / Пробки за източване с медни уплотнения / Zatvarači s mesingastim brtvama / Komplet čepova sa bakarnim zaprtivcima / Σετ χάλκινων παρεμβυσμάτων και ταπών / Tapones con juntas de cobre / Tappi con guarnizioni in rame / Tampões com anéis de cobre / Bouchons avec joints en cuivre / Krukken met messing dichting

NEO
TOOLS

x534



Ref.	☒	EAN
11-974	0/10	5907558437164

Pierścienie segera

Seeger rings / Seeger-Ring / Стопорные кольца / Кільця стопорні / Seeger gyűrűk / Inele Seeger / Segerové kroužky / Segerove kružky / Seger obroči / Žiedai Segera / Ārējie un iekšējie sprostgredzeni / Seeger ringid / Зезерну / Uskočnici / Seger prstenovi / Δακτύλιοι συγκράτησης / Anillos seger / Anelli Seeger / Anéis Seeger / Anneaux élastiques / Seeger ringen

NEO
TOOLS

x300

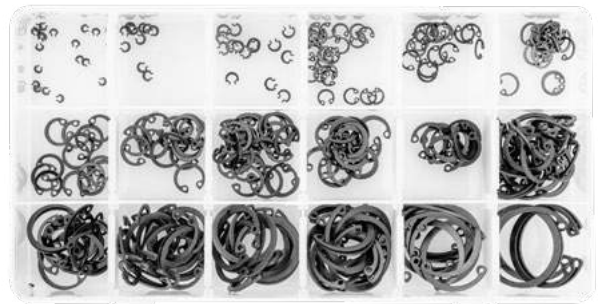

Ref.	☒	EAN
11-975	0/20	5907558437171

Zestaw smarowniczek

Set of lubricating nipples / Ölerset / Набор масленок / Набор оливиць / Zsírzszem készlet / Set de căni de ungere / Sada mazniček / Súprava mazniček / Komplet mazalnic / Sutepimo dozatorių komplektas / Ellas kanniņu komplekts / Määrdepritside komplekt / Комплект рьчни масльонки / Set dozera za mazivo / Komplet maziva / Σετ ελαιοδεξαμενών / Juego de pistolas engrasadoras / Completo di punti di ingrassaggio / Kit de lubrificadores / Jeu de tubulure de graissage / Set van smeernippels

NEO
TOOLS

x110



Ref.	☒	EAN
11-973	0/20	5907558437157

Uszczelki (O-ring HNBR)

Seals (O-ring HNBR) / Dichtungen (O-ring HNBR) / Прокладки (O-ring HNBR) / Прокладки (O-ring HNBR) / Tömítés készlet (O-gyűrű hnbr) autóklimához / Garnituri (O-ring HNBR) / Těsnění (O-ring HNBR) / Tesnenia (O-ring HNBR) / Tesnila (O-ring HNBR) / Tarpinės (O-ring HNBR) / Blīves (O-ring HNBR) / Tihendid (O-ring HNBR) / Гарнитурa (O-ring HNBR) / Brtvila (O-ring HNBR) / Zaptivke (O-ring HNBR) / Ταμιούχες (O-ring HNBR) / Juntas de calafateo (O-ring HNBR) / Guarnizioni (O-ring HNBR) / Vedantes (O-ring HNBR) / Joints (O-ring HNBR) / Dichtringen (O-ring HNBR)

NEO
TOOLS



x270

Ref.	📦	EAN
11-976	0/20	5907558437188

Uszczelki

Seals / Dichtungen / Прокладки / Прокладки / Tömítések / Garnituri / Těsnění / Tesnenia / Tesnila / Tarpinės / Blīves / Tihendid / Гарнитурa / Brtvila / Zaptivke / Ταμιούχες / Juntas de calafateo / Guarnizioni / Vedantes / Joints / Dichtringen

NEO
TOOLS

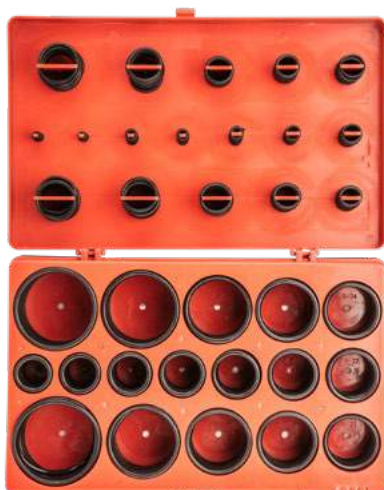

x419

Ref.	📦	EAN
11-983	1/20	5907558435788

Zestaw do demontażu szyb

Car windows disassembling set / Abbausatz für Scheiben / Набор для демонтажа лобовых стекол / Набор для демонтажу вітрового скла / Szélvédő kiszerező készlet / Set pentru demontarea geamurilor / Souprava pro demontáž skel / Súprava na demontáž okien / Set za odstranitev stekel / Automobilinių stiklų išmontavimo rinkinys / Autostiklu demontāžas komplekts / Tuuleklaasi eemaldamise komplekt / Комплект за демонтаж на автостъкла / Set za demontažu stakla / Pribor za demontiranje stakla / Σετ εξαγωγή παρμπριζ / Kit de desmontaje de ventanillas / Kit per lo smontaggio di cristalli / Kit de ferramentas de desmontagem de vidros / Kit de démontage de vitres

NEO
TOOLS



Ref.	📦	EAN
11-819	1/10	5907558436792

Refraktometr

Refraktometer / Refraktometer / Рефрактометр / Рефрактометр / Refraktómetér / Refraktometru / Refraktometr / Refraktometer / Refraktometer / Refraktometras / Refraktometers / Refraktometeer / Рефрактометр / Refraktometar / Refraktometar / Διαλασίμετρο / Refractómetro / Rifrattometro / Refrattometro / Réfractomètre

NEO
TOOLS

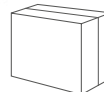

Ref.	📦	EAN
11-270	0/50	5907558436020

Chwytak magnetyczny

Magnetic holder / Magnetgreifer / Магнитный захват / Тримач магнітний / Mágneses csavarkiszedő teleszkópos / Graifár magnetic / Magnetická úchytka / Magnetický zdvihák / Magneto držalo / Magnetinis laikiklis / Magnētiskais satvērējs / Magnethaarats / Магнітен захват / Magnetska hvataljka / Magnetni hvatač / Μαγνητική αρπάγη / Agarrador magnético / Supporto magnetico / Caçamba magnética / Preneuse magnétique / Magnetisch houder

NEO
TOOLS

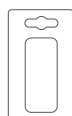

Ref.	📦	EAN
11-610	0/200	5907558418569

NEO
TOOLS

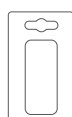

Ref.	📦	EAN
11-611	0/100	5907558418576

Lusterko inspekcijne

Inspection mirror / Inspektionsspiegel / Зеркало инспекционное / Дзеркальце інспекційне / Vizsgálótükör teleszkópos nyéllal / Oglindă de inspecție / Zrcadlo pro inspekční kontroly / Inšpekčné zrkadlo / Kontrolno ogledalo / Vaizdo veidrodelis / Inspekcijas spogulis / Kontrollspiegel / Контролно огледалце / Kontrolno ogledalo / Ogljedalo za inspekciju / Καθρεπτάκι ελέγχου / Espejo de inspección / Specchietto per ispezione / Espelho de inspeção / Miroir d'inspection / Inspectiespiegel

NEO
TOOLS

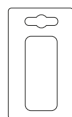

Ref.	📦	EAN
11-612	0/200	5907558418583

Miska magnetyczna

Magnetic tray / Magnetschüssel / Поддон магнитный / Піддон магнітний / Mágneses tál, rozsdamentes / Tava magnetica / Magnetická miska / Magnetická miska / Magneta posoda / Magnetinis dubenėlis / Magnētiskais trauks / Magnetauss / Магнітен картел / Magnetska posuda / Magneta činija / Μαγνητικός δίσκος / Plato magnético / Vassoio magnetico / Tacho magnético / Réceptier magnétique / Magnetische orvangbak

NEO
TOOLS



Ref.	L x W [mm]	📦	EAN
11-614	245 x 145	0/24	5907558419702

Przewody rozruchowe

Booster cables / Akku-Zusatzleitungen / Стартовые провода / Шнуры аварийного пуска аккумулятора / Indítókábel réz / Conductori de avarie pentru acumulator / Kabely pro nouzové startování k akumulátoru / Pomocné káble do akumulátora pre núdzový štart / Vážalni kabli / Automobilio ūvedimo laidai / Palašanas vadi akumulātoram / Aku avarijūhtmed / Аварийну проводниці за акумулатора / Rezervni kablovi za akumulator / Hitni kabl za akumulator / Καλώδια έκτακτης ανάγκης για ηλεκτρικό συσσωρευτή / Cables puente para la batería / Cavi di emergenza per la batteria / Cabos de emergência para bateria / Câbles de démarrage pour batterie

NEO
TOOLS



2.5m

Cu

Ref.	A max	☒	EAN
11-834	200	0/6	5907558436815
11-836	600	0/5	5907558436822

TOPEX

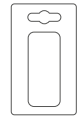

Ref.	P [A]	☒	EAN
97X250	400	0/20	5902062092526

Urządzenie rozruchowe "Jumpstarter"

Boot device "Jumpstarter" / Startgerät "Jumpstarter" / Загрузочное устройство "Jumpstarter" / Завантажувальний пристрій "Jumpstarter" / Boot eszköz "Jumpstarter" / Dispositiv de pornire „Jumpstarter” / Spouštěcí zařízení „Jumpstarter” / Zavádzacie zariadenie „Jumpstarter” / Zagonška naprava "Jumpstarter" / Įkrovos įrenginys „Jumpstarter” / Sākšanās ierīce "Jumpstarter" / Buutimisseade "Jumpstarter" / Стартово устройство "Jumpstarter" / Uređaj za pokretanje "Jumpstarter" / Уредђај за покретање система "Јумпастартер" / Συσκευή εκκίνησης "Jumpstarter" / Dispositivo de arranque "Jumpstarter" / Dispositivo di avvio "Jumpstarter" / Dispositivo de inicialização "Jumpstarter" / Périphérique de démarrage "Jumpstarter" / Opstartapparaat "Jumpstarter"

NEO
TOOLS

14 000 mAh

44.8 W

LiFePo4 long life battery

MAX 400A (engine start)

USB 1A / 2A power bank

MAX 3.5 BAR

LED light



Ref.	☒	EAN
11-997	1/4	5907558452419

Tester akumulatorów

Battery load tester / Batterietester / Тестер батареи / Тестер акумулатора / Akkumulátor tesztelő / Tester de încercare a bateriei / Tester baterii / Tester batterie / Tester akumulatorja / Akumulátorias baterijos testeris / Akumulatoru bateriju testeris / Aku tester / Тестер на батеријата / Ispitivač baterije / Испитивач батерије / Ελεγκτής φορτίου μπαταρίας / Comprobador de carga de batería / Tester di carico della batteria / Testador de carga da bateria / Testeur de charge de batterie / Acculaadtester

NEO
TOOLS



for 6/12V batteries

100A

VOLTAGE ACCURACY ±0.2V

ANALOG METER 0-16 V DC

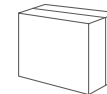

Ref.	A max	☒	EAN
11-984	100	1/10	5907558452402

NEO
TOOLS



for all 12V batteries

125A

VOLTAGE ACCURACY ±0.2V

DIGITAL METER 8-16 V DC

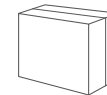

Ref.	A max	☒	EAN
11-985	125	1/10	5907558452419

NEO
TOOLS



for all 12V batteries

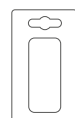

Ref.	☒	EAN
11-986	6/36	5907558452419

Prostownik

Car battery charger / Stromrichter / Выпрямитель / Выпрямляч / Egyenirányító / Redresor auto / Usměřňovač / Usměrňovač / Usmernik / Ικρονικλίσ / Akumulatora lādētājs / Aladi / Τοκοσυμπραυμεν / Ispravljaj / Ispravljaj / Ανορθωτής / Rectificador / Raddrizzatore carica batterie / Gelijkrichter

NEO
TOOLS

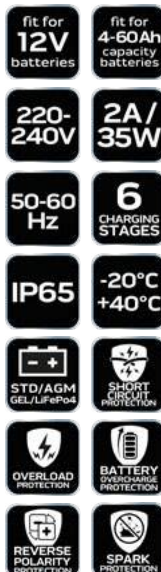

Ref.	⊠	EAN
11-890	0/10	5907558463279

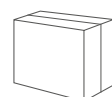

NEO
TOOLS



Ref.	[A/W]	Ah	⊠	EAN
11-891	4/70	3-120	0/10	5907558463279
11-892	6/100	3-150	0/10	5907558463279
11-893	10/160	3-200	0/10	5907558463279

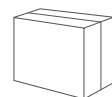

Próbnik elektryczny samochodowy

Car voltage tester / Kfz-Spannungsprüfer V / Индикатор напряжения / Индикатор напруги автомобільний / Jármű fázisérveza / Sonda de luat probe la instalații electrice la automobile / Zkoušečka napětí autoelektrikářská / Autoskúšačka / Preizkuševalec napetosti za avtomobile / Elektronis testeris automobilams / Automašinas elektrības testeris / Auto elektritester / Αυτοαυτοβιλεν φασομερ / Električni ispitivač napona / Automobilski električni tester / Συσκευή ένδειξης τάσης / Probador eléctrico para coches / Tester per auto / Testador de tensão para carros / Testeur électrique automobile / Elektrische wagen meetkop

NEO
TOOLS



6-24V

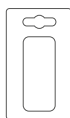

Ref.	⊠	EAN
11-832	12/240	5907558420418

TOPEX

24V



Ref.	U [V]	L [mm]	⊠	EAN
39D081	6-24	115	12/240	5902062051226

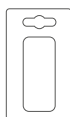

TOPEX

24V



Ref.	U [V]	L [mm]	⊠	EAN
39D082	6-24	140	24/288	5902062051233

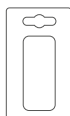

Kompresor samochodowy z osprzętem

Inflator with accessories / Akku-Kompresor mit Zubehör / Компрессор аккумуляторный с оснасткой / Компрессор аккумуляторный з принадлежностями / Kompreszor / Compresor de cumulator de cu accesorii / Akumulátorový kompresor s príslušenstvom / Akumulátorový kompresor s príslušenstvom / Akumulatorski kompresor z opremo / Automobilinis kompresorius su įranga / Akumulatora kompresors ar piederumiem / Akukompresor koos tarvikutega / Аккумуляторен компресор с оборудване / Akumulatorski kompresor s opremom / Baterijski akumulator s priborom / Συμπιεστής επαναφορτιζόμενος με βοηθητικά εξαρτήματα / Compresor a bateria con accesorios / Compresore / Compresor de ar para bateria com acessórios / Compresseur à batterie avec accessoires

TOPEX

12V

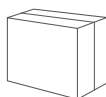

Ref.	⊠	EAN
97X501	1/20	5902062975010

Zestaw bezpieczników samochodowych

Car fuse / Set von Auto-Sicherungen / Набор автомобильных предохранителей / Набор запобіжників автомобільних / Gépkości biztosíték szett / Set de siguranțe auto / Sada pojistek do auta / Sada automobilových poistiek / Set avtomobilskih varovalk / Automobiliinių saugiklių rinkinys / Automobiliņu drošinātāji / Autokaitsmete komplekt / Комплект автомобильни предохранители / Set osigurača za auto / Komplet svećica za automobil / Σε ασφάλειες αυτοκινήτου / Conjunto de fusibles de coche / Set di fusibili per auto / Kit de fusíveis de automóveis / Ensemble de fusibles auto / Auto bougies

NEO
TOOLS

x10

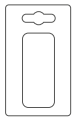

Ref. 11-991 [E] EAN 5907558435795

NEO
TOOLS

x10

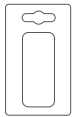
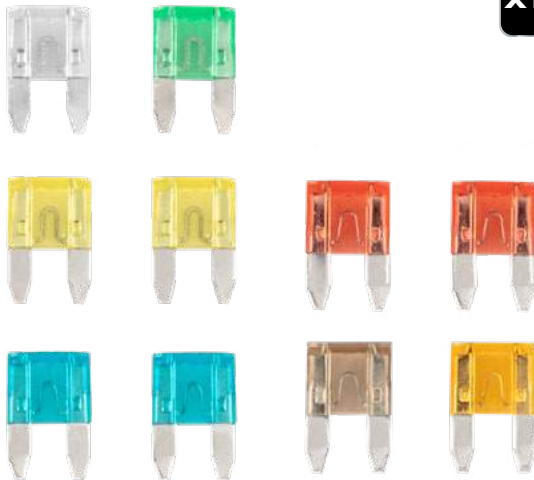

Ref. 11-992 [E] EAN 5907558435801

NEO
TOOLS

x88



Ref. 11-993 [E] EAN 5907558435818

Podnośnik przesuwny

Floor jack / Schiebeheber / Домкрат подкатной / Домкрат / Aluminium hidraulikus krokodilemelő / Cric de podea / Přenosný zvedák / Zdvihák hydraulický vozík / Hidravlična dvigalka / Domkratas / Pacelājs / Tungraud / Крук / Hidravlična auto dizalica / Hidraulicna auto dizalica / Γρύλος τρολλέι / Gato hidráulico / Sollevatore a carrello / Elevador de deslize / Cric mobile / Schuifhijshoestel

NEO
TOOLS

1.25t

H 375mm MAX
MIN 85mm

AL

CE

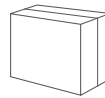

Ref. 11-730 [I] EAN 5907558416930

NEO
TOOLS

2.5t

H 455mm MAX
MIN 85mm

CE

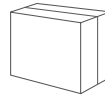

Ref. 11-731 [I] EAN 5907558416947

NEO
TOOLS

3T

H 525mm MAX
MIN 85mm

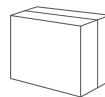

Ref. 11-732 [I] EAN 5907558436716

Podnośnik pneumatyczny

Air floor jack / Werkstattheber / Πνευματικός домкрат / Кран гаражний / Pneumatikus légrárnás emelő / Cric de atelier / Dilenský zvedák / Dielenský zdvihák / Dvigalka / Keltuvas dirbtuvėms / Profesionālais pacēlājs / Тöökojatungraud / Подъездач / Radionička dizalica / Radionička dizalica / Γεραός για υπαράζ / Gato de taller / Cric da officina / Elevador de oficina / Vérin d'atelier / Werkplaats hijstoestel /

NEO
TOOLS

3.5T  6-8 bar

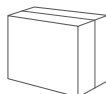

Ref.	[t]		EAN
11-735	3.5	0/1	5907558436723

Podstawki pod samochód

Jack stands / Kfz-Unterlagen / Подставки автомобильные / Підставка під автомобіль / Emelő bak / Support de ridicare / Podpěra panenka / Podpera panenka / Podstavki za hidravlično dvigalko / Automobilinis domkratas / Paliktinis zem auto / Tungraua alused / Стойка за кола / Držac za auto dizalicu / Drzac za auto dizalicu / Γρύλος σταθερός / Soporte para coche / Cavalletti di sollevamento / Suporte para carro / Supports pour voiture / Autosteunen

NEO
TOOLS

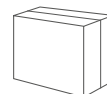
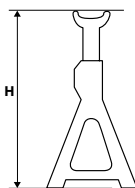

x2

Ref.	[t]	H [mm]		EAN
11-750	3	295 - 415	1/1	5907558418361
11-751	2	278 - 423	1/1	5907558418378

Podnośnik słupkowy

Bottle jack / Säulenheberät / Домкрат гидравлический бутылочный / Домкрат пляшковиый / Palackemelő / Cric coloană / Zvedák pistový / Stĺpkový zdvihák / Dvigalka / Hidraulinis keltuvas / Mastu pacēlājs / Lattungraud / Колонен подъемник / Stupna dizalica / Stubasta dizalica / Γρύλος υδραυλικός μπουκάλας / Gato hidráulico de botella / Sollevatore a bottiglia / Elevador com colunas / Cric bouteille / Paalhijstoestel

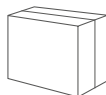

NEO
TOOLS

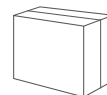

Ref.	Fmax [t]	Hmax [mm]	Hmin [mm]		EAN
11-700	2	308	158	1/6	5907558436648
11-702	5	468	212	0/6	5907558416893
11-701	8	390	205	1/4	5907558436655
11-705	20	521	241	0/4	5907558416923

TOPEX





Ref.	Fmax [t]	Hmax [mm]	 [kg]		EAN
97X032	2	181+164	2,5	0/6	5902062170026
97X033	3	194+177	2,2	0/6	5902062170033
97X035	5	216+230	4,3	1/4	5902062170040
97X040	10	230+230	6,2	0/4	5902062170057
97X042	15	230+230	8,5	0/1	5902062970428
97X043	20	242+210	10,0	0/1	5902062970435

Wciągnarka łańcuchowa

Chain block / Kettenwinde / Лебедка цепная / Таля ланцюгова / Láncos emelő / Trolui cu lant / Řetězový kladkostroj / Retázový zdvihák / Verižna dvigalka / Grandininė gervė / Kėdes vinča / Kettvint / Верхня лебедка / Lančani podizač / Lančana dizalica / Βαρούλκο με αλυσίδα / Cabria de cadena / Paranco a catena / Guincho de corrente / Treuil à chaîne / Kettingtakel

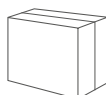

NEO
TOOLS

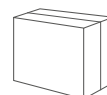

Ref.	[t]	L [m]		EAN
11-760	1	3	0/1	5907558418385
11-761	2	3	0/1	5907558418392
11-762	3	3	0/1	5907558418408
11-763	5	3	0/1	5907558418415

TOPEX



Ref.	Fmax [t]	 [kg]		EAN
97X071	1,0	8,5	1/1	5902062970718
97X072	2,0	11,0	1/1	5902062970725

Wyciągarka linowa

Cable puller / Seilwinde / Лебедка канатная / Лебідка тросова / Racsnis huzató / Dispozitiv pentru întinderea cablului / Lanový vrátek / Naviják lanový / Vlečna jeklena vrv / Keltuväs / Trošuvinača / Kaablitõmmits / Лебедка / Sajla / Sajla / Βαρύλλο αχοινίου / Cabria de cable / Paranco a cavo / Guincho de corda / Treuil à levier à câble / Lijntakel

TOPEX

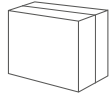

Ref.	Fmax [t]	m _{max} [kg]	☒	EAN
97X080	2	3,1	0/6	5902062200211
97X082	3,5	5,9	0/2	5902062970824

TOPEX

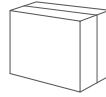

Ref.	Fmax [t]	m _{max} [kg]	☒	EAN
97X085	540	3,75	1/6	5902062970855
97X087	900	5,50	0/4	5902062970879

Leżanka warsztatowa

Car creeper / Werkstattliege / Лежанка рабочая / Візок на роликах для / Роботи під автомобілем / Szerelőgy, összecsuható / Sezlong de atelier / Dilenská lehátko / Montážne ležadlo / Delavniški ležalnik / Sulankstoma lova, dirbtuvėms / Darba gulamkrēsls / Veerevalus / Монтёрско килимче / Radionička ležaljka / Radionički kauč / Ξαλώστρα συνεργείου / Camilla de taller / Lettino sottomacchina / Carrinho de oficina / Divan d'atelier / Werkplaatsbank

NEO TOOLS

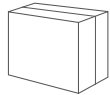

Ref.	m _{max} [kg]	☒	EAN
11-600	150	0/1	5907558418347

NEO TOOLS

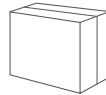

Ref.	m _{max} [kg]	☒	EAN
11-601	150	1/1	5907558445282

Podnośnik warsztatowy

Shop crane / Werkstattheber / Внутрішньохорова кран / Кран гаражний / Műhelydarú, motorkiemelő zsrírf / Cric de atelier / Dilenský zvědáč / Dilenský zdvihák / Dvigalka / Keltuväs dirbtuvėms / Profesionālais pacēlājs / Töökõjatungraud / Ποδηματ / Radionička dizalica / Radionička dizalica / Γερανός για γκαράζ / Gato de taller / Gruetta / Elevador de oficina / Vérin d'atelier / Werkplaats hijstoestel

NEO TOOLS

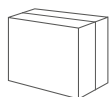

Ref.	[t]	H [mm]	☒	EAN
11-720	2	25-2382	0/1	5907558419665

Prasa hydrauliczna

Hydraulic press / Hydraulische Presse / Гидравлический пресс / Прес гидравлический / Hidraulikus prés / Presă hidraulică / Hydraulický lis / Hydraulický lis / Hidravlična stiskalnica / Hidraulinis presas / Hidrauliskā prese / Hidrauliline press / Χυδραυλική преса / Hidraulična preša / Hidraulična presa / Υδραυλική πρέσα / Prensa hidráulica / Pressa idraulica / Prensa hidráulica / Presse hydraulique

NEO TOOLS

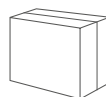

Ref.	☒	EAN
11-714	0/1	5907558436686

Stojak na silnik

Engin stand / Motorhalter / Стенд для ремонта двигателя / Стенд для ремонту двигуна / Motorszerelő állvány / Stativ pentru motor / Stojan na motor / Stojan na motor / Stojalo za motor / Variklio stovas / Dzinēja remonta statīvs / Motoristend / Стойка за двигател / Stalak za motor / Stalak za motor / Βάση επισκευής κινητήρων / Soporte para motor / Cavalletto supporto motore / Suporte de motor / Support moteur / Motor onderstel

NEO
TOOLS



Ref.	☒	EAN
11-710	0/1	5907558436662

Podnośnik do skrzyń biegów

Transmission jack / Getriebeheber / Трансмисионная стойка / Стыка трансмісійна / Sebességváltó emelő / Cric pentru cutia de viteze / Zvedák převodovek / Zdvih prevodovky / Dvigalo za menjalnik / Pavary dėžės keltuvas / Ātrumkārbas domkrats / Käigukasti tungraud / Трансмисионен подемник / Podizáč mjenjača / Dizalica za menjač brzina / Σαμάνοφόρος / Elevador de caja de engranajes / Martinetto per scatole del cambio / Elevador da caixa de velocidades / Jack de transmission

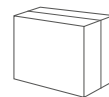

↓ ↓
500kg
min
0,9 m
max
1,9 m

Ref.	☒	EAN
11-712	0/1	5907558436679

NEO
TOOLS



0.5t
↑ 1760mm
MAX
MIN
885mm

Ref.	☒	EAN
11-711	1/1	5907558445534

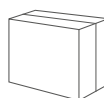

Stół warsztatowy

Work bench / Werkstattbank / Стол-верстак / Верстак / Állítható munkapad / Tejghea tímplárie / Dílenský stůl / Stůl pracovní / Delavníška miza / Darbastalis / Darba galds / Τοπίσκ / Работна маса / Stol radionički / Radni sto / Πάγκος εργασίας / Banco de trabajo / Banco da lavoro / Mesa de oficina / Etabli d'atelier / Werkplaatstafel

NEO
TOOLS

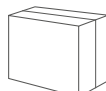

Ref.	[mm]	☒	EAN
11-716	1500 x 780 x 830 – 980 mm	0/1	5907558436693

Mata serwisowa na błotniki, magnetyczna

Car body servis cover, magnetic / Servicematten für Kotflügel, magnetisch / Накладка магнитная на крыло / Накладки магнітні до брызговики / Mágneses sárvédő takaró / Rogojini servicii pentru aripi, magnetice / Ochranné přehozy na blatníky, magnetické / Servisné rohože pre blatníky, magnetické / Servisne obloge za blatnike, magnetne / Apsauginė magnetinė dangą ant sparno / Mašinas spārna magnētiskais paklājs instrumentiem / Porilaudade hooldusmatid, magnetilised / Магнитно покрывало за калници / Servisne mate za blatobrane, magnetske / Servisne podloge za branike, magnetne / Μαγνητική ποδιά φτερού / Alfombras de servicio para guardabarros, magnéticas / Stuoie per manutenzione sui parafranghi, magnetiche / Coberturas magnéticas para para-lamas / Bâches de garde-boue magnétiques / Service matten voor spatlappen

NEO
TOOLS



☒
120x100
cm

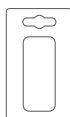

Ref.	☒	EAN
11-718	0/20	5907558436709

NEO
TOOLS



1000x630
mm

☒
CAR
WHEEL
CUTOUT

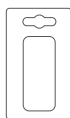

Ref.	☒	EAN
11-719	0/25	5907558459753

Linka holownicza

Tow line / Abschleppseil / Трос буксировочный / Трос буксирувальний / Vontató kötéll / Cablu de remorcare / tažné lano / vlečné lano / vlečná vrv / tempimo lymas / Vilkšanas trose / veoköis / В'язе за теплене / Sajla za vuču / Uže za vuču / Συρματόσχοινο ρυμούλκησης / Cuerda para remolque / Cavo di traino / Corda de remorque / Corde de remorquage

TOPEX



2000
kg
4m
14mm

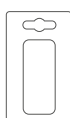

Ref.	☒	EAN
97X269	0/25	5902062972699

Olej uniwersalny

Universal oil / Universälöl / Универсальное масло / Универсальна олива / Univerzális olaj / Ulei universal / Univerzální olej / Univerzálny olej / Univerzalno olje / Universalni alyva / Universäla eļļa / Universaalne õli / Универсално масло / Univerzalno ulje / Univerzalno ulje / Λάδι γενικής χρήσης / Aceite universal / Olio universale / Óleo universal / Huile universelle / Universele olie

PRESSOL



Ref.	Info	Icon	EAN
09 096 924	200 ml	1/12	4103810420962

PRESSOL



Ref.	Info	Icon	EAN
10 597	100 ml	1/10	4103810105975

Smar (biały)

Grease (white) / Schmierfett (weiß) / Смазка (белая) / Мазило (біле) / Kenőzsír (fehér) / Unsoare (albă) / Mazivo (bílé) / Mazivo (biele) / Mazivo (bela) / Tepalas (baltas) / Směre (balta) / Määrdeaine (valge) / Грец (бяла) / Mast (bijela) / Mazivo (bela) / Λευκό γράσο / Lubrificante (blanco) / Lubrificante (bianco) / Lubrificante (branco) / Graisse (blanche) / Vet (wit)

PRESSOL



Ref.	Info	Icon	EAN
09 116	400 ml	1/12	4103810091162

Oczyszczacz hamulców

Brake cleaner / Bremsenreiniger / Очиститель тормозов / Очистник гальм / Fékisztító / Agent de curățare frână / Čistič brzd / Čistič brzd / Sredstvo za čišćenje zavor / Stabdžij valiklis / Bremžu tīrītājs / Piduripuhasti / Почистящо устройство за спирачки / Sredstvo za čišćenje kočnica / Čistač kočnica / Καθαριστικό φρένων / Limpiador de frenos / Pulitore di freni / Limpador de travões / Nettoyant pour freins / Remmenreiniger

PRESSOL



Ref.	Info	Icon	EAN
09 126	500 ml	1/12	4103810091261

Odrzewiacz

Rust remover / Rostlöser / Средство для удаления ржавчины / Засіб для видалення іржі / Rozsdaoldó / Agent de îndepărtare a ruginii / Odstraňovač rzi / Prípravok na odstraňovanie hrdze / Sredstvo za odstranjevanje rje / Rūdžiū šalinimo priemonė / Rūsas noņemšanas līdzeklis / Rooste-eemalaja / Sredstvo za odstranjavanje na rđžoda / Sredstvo za uklanjanje hrđe / Sredstvo za uklanjanje rđe / Αφαιρετικό οξυριάζ / Desoxidante / Eliminateur di ruggine / Removedor de ferrugem / Antirouille / Roestverwijderaar

PRESSOL



Ref.	Info	Icon	EAN
09 102	400 ml	1/12	4103810091025

Spray-silikon

Silicon-Spray / Silikon-Spray / Силиконовый спрей / Силиконовый спреј / Szilikon spray / Spray-silicon / Sprej-silikon / Sprej - silikón / Silikonski sprej / Purškiamas silikonas / Aerosols-silikonas / Silikoonpijp / Sprej-silikon / Sprej-silikon / Sprej-silikon / Σπρέϊ σιλικόνης / Silicóna en spray / Silicone spray / Silicone em spray / Silicone en spray / Spray-siliconen

PRESSOL



Ref.	Info	Icon	EAN
09 124	400 ml	1/12	4103810091247

Smar uniwersalny

Universal grease / Universalfett / Смазка универсальная / Мазило универсальне / Univerzális kenőzsír / Lubrifiant universal / Víceúčelové mazivo / Univerzálné mazivo / Univerzalno mazivo / Universalus tepalas / Universäla směre / Universaalne määrdeaine / Универсална зрец / Višenamjenska mast / Mazivo univerzalno / Γράσο γενικής χρήσης / Lubrificante universal / Lubrificante universale / Lubrificante universal / Graisse universelle / Universeel vet

PRESSOL



Ref.	Info	Icon	EAN
10 564	80 g	1/10	4103810105647

Kanister na wodę

Can for water / Wasserbehälter / Канистра для воды / Канистра для воду / Vizeskanna / Bidon de apă / Kanistr na vodu / Kanistra na vodu / Kanister za vodo / Bakas vandeniui / Üdens kanna / Veekanister / Бидон за вода / Kanister za vodu / Kanta za vodu / Κάνιστρα νερού / Bidón para agua / Tanica per l'acqua / Tanque para água / Jerricane à eau / Jerrycan voor water

PRESSOL



Ref.	Info	Icon	EAN
21 163	10 l	1/0	4103810211638
21 165	15 l	1/0	4103810211652
21 167	20 l	1/0	4103810211676
21 169	35 l	1/0	4103810211690

Olejarka

Oiler / Ölör / Маслѐнна / Оливница / Olajozó / Gresor de ulei / Maznička / Olejnička / Oljnica / Tepalinė / eļļas kanniņa / Ölkann / Масло̀нка / kantica za ulje / Kantica za podmazivanje uljem / Δοχείο λιπαντικού / Aceitera / Oliatore / Máquina de pôr óleo / Graisseur à huile / Smeertoestel

NEO
TOOLS



350
cm³

250 mm

Ref.	L[mm]	☒	EAN
11-512	250	10/100	5907558415377

PRESSOL



Ref.	Info	☒	EAN
05 114	350 ml	1/6	4103810051142
05 115	500 ml	1/6	4103810051159

TOP TOOLS



300
ml

Ref.	Info	☒	EAN
77P505	130 mm	10/60	5902062151292

Dozownik do oleju

Liquid measure / Öldosierungseinheit / Стакан измерительный / Дозатор оливної / Olajadagoló / Dozator de ulei / Dávkovač na olej / Dávkovač oleja / Dozirmik za olje / Tepalo dozatorius / Eļļas dozētājs / Ölidosator / Маслен дозатор / Dozer za ulje / Dozer za ulje / Μεζούρα λαδιού / Dosificador para aceite / Dosatore per olio / Dispensador de óleo / Doseur d'huile / Doseermaat voor olie

PRESSOL



Ref.	Info	☒	EAN
07 605	5 l	1/6	4103810076053

Naczynie pomiarowe z pokrywką

Measurement vessel with cover / Messbecher mit Deckel / Мерный сосуд с крышкой / Мірна посудина з кришкою / Mérőedény fedéllel / Vas de măsurare cu capac / Měřicí nádoba s víkem / Odměrná nádoba s vekom / Merilna posoda s pokrovom / Matavimo indas su dangteliu / Mērišanas trauks ar vāku / Kaanega mõõtenõud / Измервателен съд с капак / Mjerna posuda s poklopcem / Merna posuda sa poklopcem / Δοσομετρητής με καπάκι / Recipiente de medición con tapa / Misurino con copercchio / Recipiente de medida con tampa / Réceptient de mesure avec couvercle / Maatbeker met deksel

PRESSOL



Ref.	Info	☒	EAN
07 621	1 l	1/6	4103810076213
07 622	2 l	1/6	4103810076220
07 623	3 l	1/6	4103810076237

Smarownica na pojemniku

Grease pump with container / Schmiergerät mit Behälter / Маслораздаточная установка / Дозатор оливи на ёмкости / Tartályos zsírzó / Gresorul cu rezervor / Maznice na zásobníku / Maznica na zásobníku / Mazalnik z rezervoarjem / Tepalinė su talpykla / Eļļas sadales iekārta / Ölípistola koos õlimahutiga / Масло̀нка с резервоар / Mazalica na spremniku / Mazalica na kontejneru / Δοσομετρική αντλία παροχής λιπαντικού / Engrasadora con depósito / Pompa manuale per grasso / Lubrificador no recipiente / Graisseur sur récipient / Smeerapparaat op bak

PRESSOL



Ref.	Info	☒	EAN
17 786	8 kg	1/0	4103810177866

Smarownica pneumatyczna

Pneumatic grease gun / Pneumatiches Schmiergerät / Солидолагнетатель пневматический / Дозатор оливи пневматичний / Pneumatikus zsírzó / Gresor pneumatic / Pneumatická maznice / Maznica pneumatická / Pnevmatiski mazalnik / Tepalinė pneumatinė / Pnevmatiska solidola spiede / Pnevmaatiline õlipüstol / Масло̀нка пневматична / Pneumatska mazalica / Pneumatska mazalica / Γρασαδόρος αέρος / Engrasadora neumática / Ingrassatore pneumatico / Lubrificador pneumático / Graisseur pneumatique / Pneumatisch smeerapparaat

PRESSOL



Ref.	Info	☒	EAN
18 071	500 cm ³ + 12 635 + 12 631	1/0	4103810180712

Smarownica nożna

Foot grease pump / Fuß-Schmiergerät / Маслораздаточная установка / Оливорозпилювач ніжний / Lábpedálos zsírzó / Gresor actionat cu piciorul / Nožní maznice / Maznica poźná / Nožni mazalnik / Mobilni tepalo talpykla / Eļļas sadales iekārta / Jalg-õlipüstol / Крачна маслянка / Nožna mazalica / Nožna mazalica / Δοσομετρική αντλία παροχής λιπαντικού / Engrasadora de pie / Pompa a pedale per grasso / Lubrificador de comando de pernas / Graisseur à pied / Voetsmeerapparaat

PRESSOL



Ref.	Info	☒	EAN
17 793	15 kg	1/0	4103810177934

Zlewarka oleju

Oil drain tank / Ölabgießer / Сливная воронка для масла / Обладнання для зливання оливи / Olajleeresztő tartály / Cuvetă de scurgerea uleiului / Slévačka oleje / Nádrž na zachytávanie oleja / Zbiralnik olja / Tepalo išleidiklis / Eļļas piltuve / Ölliefertrite komplet / Машина за изливане на масло / Aparat za skupljanje ulja / Ddliivak za ulje / Χωνί λαδιού / Dispositivo de drenaje de aceite / Recuperatore olio / Máquina de remoção de óleo / Cuve à récupérer l'huile / Verbindungsstuck

PRESSOL



Ref.	Info	☒	EAN
27 030	70 l	1/0	5902062153326
27 070	70 l	1/0	5902062153333

Pompa ręczna do oleju

Hand pump for oil / Handölpumpe / Ручной насос для масла / Pompa ręczna do oliwi / Kézí olajpumpa / Pompa manuală, pentru ulei / Ruční pumpra na olej / Ručné čerpadlo na olej / Ročna črpalčka za olje / Rankinė alyvos pompa / Manuālais eļļas sūkņis / Käsi-õlipump / Ръчна маслена помпа / Ručna pumpra za ulje / Ručna pumpra za ulje / Χειροκίνητη αντλία λαδιού / Bomba manual para aceite / Pompa dell'olio manuale / Bomba de óleo manual / Pompe à main à huile / Handpomp voor olie

PRESSOL



Ref.	Info	☒	EAN
13 012	18 l / min.	1/0	4103810130120
13 020	7 l / min.	1/0	4103810130205
13 055	15 l / min.	1/0	4103810130557

Odsysarka oleju

Oil suction machine / Ölabsauger / Отсосное устройство для масла / Оливодісмоктувач / Olajleszívó / Aspirator de ulei / Odsávačka oleje / Odsávačka oleja / Aspirator za olje / Alyvos siurbtukas / Eļļas atsūcējs / Öliimur / Вакуумна помпа за масло / Skupljač ulja / Usisivač za ulje / Αναρροφητήρας λαδιού / Dispositivo de extracción de aceite / Aspiratore olio / Máquina de remover óleo / Vidangeur d'huile / Oliefzuiger

PRESSOL



Ref.	Info	☒	EAN
27 622	70 l	1/0	5902062153340
27 632	70 l	1/0	5902062153357

Zestw pneumatyczny do smaru

Air operated grease kit / Ölset pneumatisch / Пневматический набор для смазывающего вещества / Комплект пневматичний до мастила / Pneumatikus felszerelés kenőzsírokhoz / Set pneumatic pentru unsoare consistentă / Pneumatická sada pro mazivo / Pneumatická súprava na mazanie / Pnevmatiski komplet za mazivo / Pneumatinis komplektas, tepalui / Smērvielas pneimatiskais komplekts / Pneumaatlīne tādārekomplekt / Пневматичен смазочен комплект / Pnevmatiski set za mazivo / Pnevmatiski pribor za mazivo / Πνευματικό σετ για λιπαντικό / Juego de herramientas neumáticas para engrase / Completo pneumatico per il grasso / Kit pneumático p. lubrificação / Jeu d'accessoires pneumatiques à graisse / Lasappararat

PRESSOL



18 417 051



18 766 950

Ref.	Info	☒	EAN
18 417 051	50:1, 20 kg	1/0	5902062154026
18 766 950	50:1, 50 kg	1/0	5902062154040

PRESSOL



27 846



27 846-950

Ref.	Info	☒	EAN
27 846	50:1, 50/60 kg	1/0	5902062154026
27 846-950	50:1, 20 kg	1/0	5902062154040





ПНЕУМАТИКА
PNEUMATICS
ПРЕВМАТИЧЕСКИЙ ИНСТРУМЕНТ



Klucz pneumatyczny udarowy

Pneumatic impact wrench / Pressluftschlagschlüssel / Ключ пневматический ударный / Ключ пневматичний ударний / Pneumatikus ütvecsavarozó / cheie pneumatică de lovit / Pneumatický nárazový klíč / Pneumatická rázová utáhovačka / Pnevmatiski udarni vijac / Pneumatinis, smūginis veržliaraktis / Pnevmatiskā slēna pistole / Pnevmaatiline löök-mutrivõti / Γαϊκούεργμ пневματιμечен / Pnevmatiski Ključ udarni / Pnevmatiski ključ / Συρπί αέρος αναστρεφόμενο / Llave de impacto neumática / Chiave pneumatica a percussione / Chave pneumática de impacto / Clef pneumatique à chocs / Pneumatisch slagsteulet

NEO
TOOLS



Ref. EAN
14-002 1/6 5907558442533

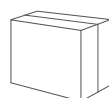

NEO
TOOLS



Ref. EAN
14-008 1/4 5907558442564

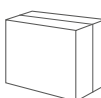

NEO
TOOLS



Ref. EAN
14-006 1/6 5907558442557

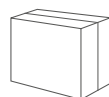

NEO
TOOLS



Ref. EAN
14-004 1/6 5907558442540

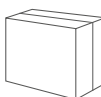

NEO
TOOLS



Ref. EAN
14-500 1/10 5907558442557

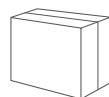

NEO
TOOLS



Ref. EAN
14-502 1/5 5907558444841

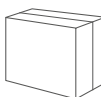

Klucz pneumatyczny udarowy

Pneumatic impact wrench / Pressluftschlagschlüssel / Ключ пневматический ударный / Ключ пневматичний ударний / Pneumatikus ütvecsavarozó / cheie pneumatică de lovit / Pneumatiký nárazový klíč / Pneumatická rázová uťahovačka / Pnevmatiski udarni vijač / Pneumatinis, smūginis veržiaraktis / Pneimatiskā sitiēna pistole / Pneumaatiline löök-mutrivõti / Гаїноверт пневматичен / Pnevmatiski Ključ udarni / Pnevmatiski ključ / Σφύρι αέρος αναστρεφόμενο / Llave de impacto neumática / Chiave pneumatica a percussione / Chave pneumática de impacto / Clef pneumatique à chocs / Pneumatisch slagsleutel

NEO
TOOLS

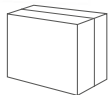

Ref. 14-010
EAN 5907558442571

Szlifierka prosta pneumatyczna

Pneumatic straight grinder / Schleifmaschine gerade pneumatisch / Прямой пневматический шлифовальный аппарат / Шліфмашинка пряма пневматична / Pneumatikus egyenes csiszológép / Polizor simplu, pneumatic / Přímá pneumatická bruska / Pneumatická jednoduchá brúška / Pnevmatiski premi brusilnik / Pneumatinis, tiesinis šlifuoškis / Pneimatiskā taisna slīpmašīna / Pneumaatiline lihtlihvija / Обикновен пневматичен шлайф / Pnevmatiska jednostavna brusilica / Pnevmatiska prosta obična brusilica / Ευθείς λιαντήρας αέρος / Amoladora neumática recta / Smerigliatrice pneumatica dritta / Disco de limar reto pneumático / Meuleuse droite pneumatique / Pneumatische rechte schuurmachine

NEO
TOOLS

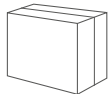

Ref. 14-014
EAN 5907558442595

Szlifierka oscylacyjna pneumatyczna

Pneumatic finishing sander / Vibrationsschleifer pneumatisch / Колебательный пневматический шлифовальный аппарат / Шліфмашинка осциляційна пневматична / Pneumatikus vibrációs csiszoló / Polizor oscilatoriu, pneumatic / Oscilační pneumatická bruska / Pneumatická vobračná brúška / Pnevmatiski vibracijski brusilnik / Vibracinis, pneumatinis šlifuoškis / Pneimatiskā oscilācijas slīpmašīna / Pneumaatiline taldlihvija / Осцилаторен пневматичен шлайф / Pnevmatiska vibracijska brusilica / Pnevmatiska oscilatorna brusilica / Παλμικό τριβείο αέρος / Lijadora neumática orbital / Levigatrice a delta pneumatica / Disco de limar oscilante pneumático / Meuleuse oscillatoire pneumatique / Pneumatische oscillatie schuurmachine /

NEO
TOOLS

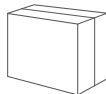

Ref. 14-018
EAN 5907558442618

Klucz kątowy pneumatyczny

Pneumatic angle wrench / Winkelschlüssel pneumatisch / Ключ угловой пневматический / Мутроверт кутовий пневматичний / Pneumatikus racsnis kulcs / Cheie unghiulară, pneumatică / Uhlový klíč pneumatický / Pneumatiký uhlový klíč / Pnevmatiska raglja / Pneumatinis kampinis raktas / Pneimatiskā leņķu atslēga / Pneumaatiline nurkvõti / Ёглов пневматичен ключ / Pnevmatiski kutni ključ / Pnevmatiski ugaoni ključ / Κλειδί γωνιακό αέρος / Llave articulada neumática / Chiave pneumatica angolare / Chave de canto pneumática / Clef d'angle pneumatique / Pneumatisch haaksleutel

NEO
TOOLS

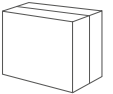

Ref. 14-012
EAN 5907558442588

Szlifierka pneumatyczna kąтова

Pneumatic angle grinder / Pressluftwinkelschleifer / Машина шлифовальная угловая пневматическая / Шліфмашинка пневматична наріжна / Pneumatikus csiszoló / Mašinā pneumaticā de šleifuit sub unghi / Pneumatická bruska úhlová / Brúška pneu. uhlová / Kotni pnevmatiski brusilnik / Pneumatinis kampinis šlifuoškis / Pneimatiskā leņķa slīpmašīna / Pneumaatiline nurklihvimisasin / Ёгловлаїф пневматичен / Pnevmatiska kutna brusilica / Pnevmatiska brusilica / Γωνιακός τροχός αέρος / Amoladora neumática angular / Retifcatrice pneumatica angolare / Disco de limar p. cantos pneumático / Meuleuse pneumatique d'angle / Pneumatische verstekschuurmachine

NEO
TOOLS

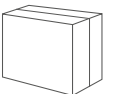

Ref. 14-016
EAN 5907558442601

Szlifierka pneumatyczna kąтова

Pneumatic angle grinder / Pressluftwinkelschleifer / Машина шлифовальная угловая пневматическая / Шліфмашинка пневматична наріжна / Pneumatikus csiszoló / Mašinā pneumaticā de šleifuit sub unghi / Pneumatická bruska úhlová / Brúška pneu. uhlová / Kotni pnevmatiski brusilnik / Pneumatinis kampinis šlifuoškis / Pneimatiskā leņķa slīpmašīna / Pneumaatiline nurklihvimisasin / Ёгловлаїф пневматичен / Pnevmatiska kutna brusilica / Pnevmatiska brusilica / Γωνιακός τροχός αέρος / Amoladora neumática angular / Retifcatrice pneumatica angolare / Disco de limar p. cantos pneumático / Meuleuse pneumatique d'angle / Pneumatische verstekschuurmachine

NEO
TOOLS

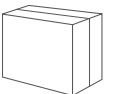

Ref. 14-508
EAN 5907558444858

Szlifierka mimośrodowa pneumatyczna

Pneumatic orbital sander / Exzenterschleifer pneumatisch / Эксцентриский пневматический шлифовальный аппарат / Шліфмашина ексцентрикова пневматична / Pneumatikus excentersiszoló / Polizor excentric, pneumatic / Pneumatická excentrická bruska / Pneumatická excentrická brúska / Pnevmatiski ekscentrični brusilnik / Pneumatinis, ekscentrinis šlijfuoklis / Pneumatiska ekscentriska slīpmašīna / Pneumatiline eksstentriklīhvija / Пневматичен ексцентършлайф / Pneumatska ekscentarska brusilica / Pneumatska ekscentrična brusilica / Εκκεντρο τριβείο αέρος / Lijadora neumática excéntrica / Levigatrice orbitale pneumatica / Disco de limar para excéntrico pneumática / Meuleuse excentrique pneumatique / Pneumatische excenter schuurmachine

NEO
TOOLS

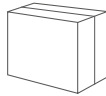

Ref. 14-020
1/12
EAN 5907558442625

NEO
TOOLS

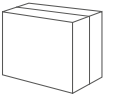

Ref. 14-510
1/10
EAN 5907558446357

Wiertarka pneumatyczna

Pneumatic drill / Bohrmachine pneumatisch / Дрель пневматическая / Дрель пневматичний / Pneumatikus fúrógép / Masina de gaurit pneumatica / Pneumatická vrtačka / Pneumatická vrtačka / Pnevmatiski vrtalnīk / Pneumatinis gręžtuvas / Pneumatiska urbjmašīna / Pneumaatiline trell / Пневматична пробивна машина / Pneumatska bušilica / Pneumatska bušilica / Δράπανο αέρος / Taladradora neumática / Trapano pneumatico / Berbequim pneumático / Erçeuse pneumatique / Pneumatische boormachine

NEO
TOOLS

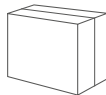

Ref. 14-026
1/10
EAN 5907558442632

NEO
TOOLS

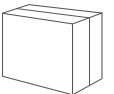

Ref. 14-514
1/10
EAN 5907558444865

Młotek udarowy pneumatyczny

Pneumatic impact hammer / Schlaghammer pneumatisch / Молоток ударный пневматический / Перфоратор пневматичний / Pneumatikus vésőkalapács / Ciocan cu percucie pneumatică / Pneumatické rázové kladívko / Pneumatické príklepové kladívko / Pnevmatisko udarno kladivo / Pneumatinis atskėlimo plaktukas / Pnevmatiskais sitamais āmurs / Pneumaatiline löökvasar / Пневматичен ударен чук / Pnevmatiski udarni čekić / Udarni pnevmatski čekić / Κρουστική σφύρα αέρος / Martillo neumático de impacto / Martello pneumatico / Martelo de impacto pneumático / Martelet à chocs pneumatique / Pneumatische slaghammer

NEO
TOOLS

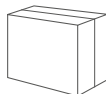

Ref. 14-028
1/5
EAN 5907558442649

NEO
TOOLS



Ref. 14-029
4/24
EAN 5907558455298

Sprężyny

Springs / Federn / Пружини / Пружини / Rugó készlet / Arcuri / Pružiny / Pružiny / Vzmeti / Spyruoklių rinkinys / Atsperes / Vedrud / Пружини / Opruge / Opruge / Σετ ελατήρια / Espiraes / Molle / Molas / Ressorts / Veren

NEO
TOOLS



Ref. 14-030
4/40
EAN 5907558455304

Zszywacz pneumatyczny

Pneumatic stapler / Pneumatische Heftmaschine / Степлер пневматический / Степлер пневматичний / Pneumatikus tűzőgép / Capsator pneumatic / Pneumatická sešivačka / Pneumatická zošivačka / Pnevmatiski spenjač / Pneumatinis kablių pistoletas / Pneumatiskais skavotājs / Pneumaattiline klambripistol / Пневматичен мейбод / Pneumatska klamerica / Pneumatska heftalica / Συρραπτικό αέρος / Grapadora neumática / Graffettatrice pneumatica / Máquina de pontear pneumática / Agrafeuse pneumatique / Pneumatische hechtmaschine

NEO
TOOLS

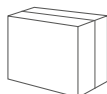

Ref. 14-570
EAN 5907558444872

NEO
TOOLS

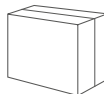

Ref. 14-572
EAN 5907558444889

Filtr odwadniacz

Draining filter / Entwässerungsfilter / Филтър / Филтър сепараторний / Víztelenítő szűrő, fémházas / Filtru - dezodorizant / Odvodňovací filtr / Odvodňovací filter / Odvodni filter / Filtras- džiovintuvus / Atūdeņošanas filtrs / Veefilter / Филтър за отводняване / Filtrar za upijanje vode / Odvodni filter / Φίλτρο-διαχωριστής / Filtro de drenaje / Filtro di drenaggio / Filtro / Filtre purgeur / Filter drainage

NEO
TOOLS

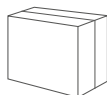

Ref. 14-732
EAN 5907558452228



NEO
TOOLS

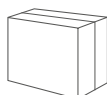

Ref. 14-730
EAN 5907558452211



Zestaw do uzdatniania powietrza

Air treatment kit / Luftaufbereitungsset / Набор для очистки воздуха / Комплект до підготовки повітря / Levegőelőkészítő egység / Garnitură de innobilarea aerului / Sada pro úpravu vzduchu / Súprava na upravnovanie vzduchu / Komplet za obdelavo zraka / Suslęgto oro apdorojimo įrenginys / Gaisa attīršanas komplekts / Ūhupuhašuskomplekt / Комплект за подготовка на въздуха / Set za pripremu zraka / Pribor za tretiranje vazduh / Σετ καθαρισμού αέρος / Dispositivo de procesamiento del aire / Filtro, riduttore, lubrificatore / Kit para purificar ar / Jeu pour traitement d'air / Set van mondstukken voor zandblazen

NEO
TOOLS

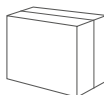

Ref. 14-734
EAN 5907558452235



Nasadka udarowa

Impact socket / Schlagaufsatz / Насадка ударная / Патрон перфораторный / Gépi dugókulcs / Brűtarű cu percutiє / Přikleповý nástavec / Prikleповý nástavec / Udarni nasadni ključ / Antgalis kalimui / Triecienuzgalis / Lööksak / Ударна наставка / Udarni nasadni nastavak / Ударна кариса / Упоδοχή κρουστικού ανταλλακτικού / Llave de vaso para atornilladores de impacto / Bussola esagonale / Bocal de impacto / Douille à choc / Slagdrop

NEO
TOOLS

CrMo
steel

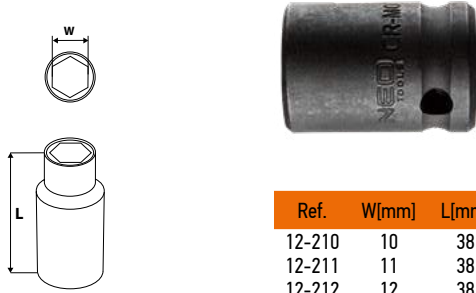

Ref.	W[mm]	L[mm]	☒	EAN
12-210	10	38	20/200	5907558423808
12-211	11	38	20/200	5907558423815
12-212	12	38	20/200	5907558423822
12-213	13	38	20/200	5907558423839
12-214	14	38	20/200	5907558423846
12-215	15	38	20/200	5907558423853
12-216	16	38	20/200	5907558423860
12-217	17	38	20/200	5907558423877
12-219	19	38	20/200	5907558423884
12-221	21	38	20/200	5907558423891
12-222	22	38	20/200	5907558423907
12-224	24	38	20/200	5907558423914

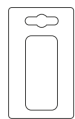

NEO
TOOLS

CrMo
steel



Ref.	W[mm]	L[mm]	☒	EAN
12-310	10	78	10/100	5907558423921
12-311	11	78	10/100	5907558423938
12-312	12	78	10/100	5907558423945
12-313	13	78	10/100	5907558423952
12-314	14	78	10/100	5907558423969
12-315	15	78	10/100	5907558423976
12-316	16	78	10/100	5907558423983
12-317	17	78	10/100	5907558423990
12-319	19	78	10/50	5907558424003
12-321	21	78	10/50	5907558424010
12-322	22	78	10/50	5907558424027
12-324	24	78	10/50	5907558424034

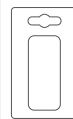

NEO
TOOLS

CrV
steel 1/2" x10

1/2" - 10, 12, 13, 14, 16, 17, 19, 21, 22, 24 mm

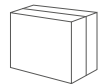

Ref. ☒ EAN
12-101 0/20 5907558414509

NEO
TOOLS

CrMo
steel 1" x9

1" - 27, 30, 32, 35, 36, 38, 41, 42, 50 mm



Ref. ☒ EAN
12-105 0/2 5907558414530

NEO
TOOLS

CrV
steel 1/2" x11

1/2" - 10, 11, 12, 13, 14, 16, 17, 19, 21, 22, 24 mm

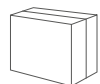

Ref. ☒ EAN
12-102 0/10 5907558414516

NEO
TOOLS

CrMo
steel 1/2" x9

E10, E11, E12, E14, E16, E18, E20, E22, E24



Ref. ☒ EAN
12-110 0/20 5907558414554

NEO
TOOLS

CrMo
steel 1/2" x10

1/2" - 10, 12, 13, 14, 15, 17, 19, 21, 22, 24 mm

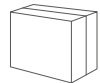

Ref. ☒ EAN
12-107 0/10 5907558414547

NEO
TOOLS

CrMo
steel 3/4" x8

3/4" - 126, 27, 29, 30, 32, 35, 36, 38 mm

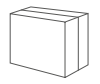

Ref. ☒ EAN
12-115 0/6 5907558414523

Klucze udarowe torx

Impact Torx bit socket set / Torx-Schlagschrauber-Satz / "Набор ударных торцевых ключей Torx" / Набор ключів ударних «Торх» / Torx gépi kulcsok / Chei cu impact torx / Nástrčné klíče torx / Rázové klíče torx / Udarni nasadni ključ Torx / Sműginiai raktai „TORX” / Triecienslēgas torx / Torx-löökvõtmed / Ударни ключове торх / udarni ključevi torx / Udarni ključevi torx / Σε κρουστικά μπουλονόκλειδα Torx / Llaves de impacto torx / Inserti Torx / Jogo de chaves de percussão torx / Clés à choc torx / Torx slagsleutels

NEO
TOOLS

CrMo
steel 1/2" x8

T25, T27, T30, T40, T45, T50, T55, T60



Ref. ☒ EAN
08-712 0/20 5907558418620

Zestaw nasadek

Socket set / Aufsatzset / Набор головок торцевых / Набор насадок торцевых / Dugókulcs készlet alufelnihez, vékonyfalú / Set duze / Sada násadek / Súprava nástr. ključov / Garnitura nasadnih ključev / Antgalių rinkinys / Muciņu komplekts / Padrumnikomplekt / Гедоре компл / Šesterokutne kapice / Gedora set / Συλλογή καρδαικίων / Llaves de vaso / Set di boccole / Kit de bicos / Jeu de douilles / Set van doppen

NEO
TOOLS

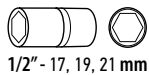

1/2" - 17, 19, 21 mm



Ref.	📦	EAN
12-350	0/20	5907558435849

Przewód ciśnieniowy spiralny

High pressure spiral hose / Spiraldruckleitung / Шланг сжатого воздуха спиральный / Шланг високого тиску / Pneumatikus spiráltömlő / Furtun spiral presiune înaltă / Tlakové potrubí spirálové / Vysokotlaká spirálová hadica / Visokotlačna spiralna gibka cev / Spiralinė aukšto slėgio žarna / Spirälveida gaisa cauruļvads / Kõrgsurveaotlik (spiraal) / Маркуч за компресор / Spiralno crijevo najlonsko / Crevo za visoki pritisak / Σπυροειδής ρύγχος υψηλής πίεσης / Tubo de presión / Tubo a spirale in nylon / Cabo de tensão espiral / Durite de pression hélicoïdale / Spiraal drukleiding

NEO
TOOLS

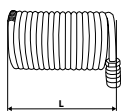

Ref.	L [m]	⌀ [mm]	▶ [mm]	📦	EAN
12-070	5	6,5	10,0	0/50	5907558414448
12-071	10	6,5	10,0	0/20	5907558414455
12-072	15	6,5	10,0	0/20	5907558414462
12-074	5	8,0	12,0	0/25	5907558414479
12-075	10	8,0	12,0	0/20	5907558414486
12-076	15	8,0	12,0	0/15	5907558414493

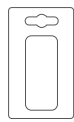

NEO
TOOLS

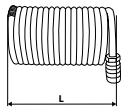

Ref.	L [m]	⌀ [mm]	▶ [mm]	📦	EAN
14-800	15	10,0	15,0	0/10	5907558444667
14-802	15	12,0	17,0	0/10	5907558444674

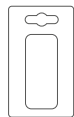

NEO
TOOLS

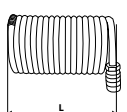

Ref.	L [m]	⌀ [mm]	▶ [mm]	📦	EAN
14-808	5	5,0	8,0	0/50	5907558457865
14-804	10	5,0	8,0	0/25	5907558444681
14-806	15	5,0	8,0	0/25	5907558444698

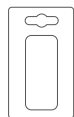

Przewód ciśnieniowy zbrojony

High pressure reinforced hose / Druckleitung verstärkt / Шланг высокого давления армированный / Шланг високого тиску, армований / Pneumatikus tömlő / Furtun armat presiune înaltă / Tlakové potrubí vyztužené / Vysokotlaká hadica / Visokotlačna gibka cev / Sustiprinta aukšto slėgio žarna / Augstspiediena gaisa cauruļvads / Tugevatud kõrgsurveaotlik / Маркуч за вис. налягане / crijevo za visoki pritisak / Crevo za visoki pritisak / Ενισχυμένος ρύγχος υψηλής πίεσης / Tubo de presión reforzado / Tubo a pressione rinforzato / Cabo de tensão armado / Durite de pression armée

NEO
TOOLS



Ref.	L [m]	⌀ [mm]	▶ [mm]	P _{max} [bar]	📦	EAN
12-079	50	8,0	13,0	19	0/1	5907558414936
12-080	50	10,0	15,0	17	0/1	5907558414943
12-081	50	12,0	17,0	13	0/1	5907558414950

Końcówka do szybkozłączki

Quick coupler tip / Endstück für Schnellkupplung / Наконечник быстрого соединения / Насадка для швидко рознімної муфти / Pneumatikus csatlakozó külsőmenet-gyorsvég / Piesă de conectare rapidă / Копцовка про рыхлосpojku / Nástavec rychlospojo / Nastavec za hitro spojko / Greitaięis jungties antgalis / Ātrsvienojuma uzgalis / Kiirühendusotsak / Накрайник за бърза връзка / nastavak za spojnicu / Kraj za brzo priključivanje / Κεφαλή ταχείας σύνδεσης / Voquilla para acoplar rápido / Connettore rapido con presa per tubo / Ponteiro do uniões rápidas / Embout pour raccord rapide / Eindstuk voor snelkoppeling

NEO
TOOLS

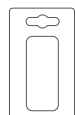

Ref.	⌀ [mm]	▶ [mm]	📦	EAN
12-605	6	8	0/27	5907558417715
12-606	8	10	0/36	5907558417722

NEO
TOOLS



Ref.	▶ [mm]	📦	EAN
12-625	7	0/36	5907558417852
12-626	8	0/36	5907558417869
12-627	10	0/36	5907558417876
12-628	12	0/36	5907558417883

NEO
TOOLS



Ref.	📏 ["]	📦	EAN
12-640	1/4	0/30	5907558417951
12-641	3/8	0/36	5907558417968

NEO
TOOLS



Ref.	📏 ["]	📦	EAN
12-655	1/4	0/36	5907558418019
12-656	3/8	0/36	5907558418026

Szybkozłączka

Quick coupler / Schnellkupplungen / Быстросменная муфта / Муфта шведкорознімна / Pneumatikus gyorscsatlakozó / Conector rapid / Rychlospojka / Rýchlospojka / Hitra spojka / Greitoji jungtis / Ātrsvienotājs / Kiirühendus / Бърза връзка / Spojnica / Brzo odvajanje / Συζευκτήρας ταχείας απελευθέρωσης / Acoplador rápido / Connettore rapido con presa per tubo / União rápida / Rapport rapide / Snelkoppeling

NEO TOOLS



NEO TOOLS

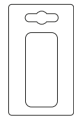

Ref.	⌀ [mm]	⌀ [mm]	⊠	EAN
12-600	4	6	0/36	5907558417685
12-601	6	8	0/27	5907558417692
12-602	8	10	0/27	5907558417708

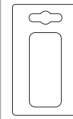

Ref.	⌀ [mm]	⊠	EAN
12-620	7	0/36	5907558417814
12-621	8	0/36	5907558417821
12-622	10	0/36	5907558417838
12-623	12	0/36	5907558417845

NEO TOOLS



NEO TOOLS

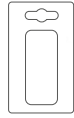

Ref.	⌀ [mm]	⊠	EAN
12-630	7	0/36	5907558417890
12-631	8	0/36	5907558417906
12-632	10	0/36	5907558417913

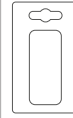

Ref.	⊠ ["]	⊠	EAN
12-635	1/4	0/36	5907558417920
12-636	3/8	0/36	5907558417937
12-637	1/2	0/36	5907558417944

NEO TOOLS



NEO TOOLS

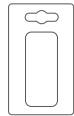

Ref.	⊠ ["]	⊠	EAN
12-645	1/4	0/36	5907558417975
12-646	3/8	0/36	5907558417982

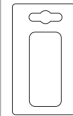

Ref.	⊠ ["]	⊠	EAN
12-650	1/4	0/36	5907558417999
12-651	3/8	0/36	5907558418002

Złącze do węży

Hose connection / Schlauchverbinder / Соединители для шланга / Арматура до шлангу / Pneumatikus tömlőtoldó / Imbinare de furtun / Spojka pro hadici / Spoj na hadicu / Konektor za cev / Jungtis žarnai / Šļūtenes savienotāji / Voolikiühendus / Съединение за шланга / Spopa za cijev / Spoj za cevo / Σύνδεσμοι εύκαμπτου σωλήνα / Junta para manguera / Connettore per tubo / União p. Mangueira / Raccord pour flexible / Verbindingsstuk voor slang

NEO TOOLS



NEO TOOLS

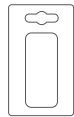
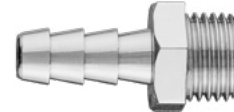

Ref.	⌀ [mm]	⊠	EAN
12-610	6	0/36	5907558417739
12-611	8	0/36	5907558417746
12-612	10	0/36	5907558417753
12-613	12	0/36	5907558417760

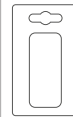

Ref.	⌀ [mm]	⊠ ["]	⊠	EAN
12-615	6	1/4	0/36	5907558417777
12-616	10	1/4	0/36	5907558417784
12-617	10	1/2	0/36	5907558417791
12-618	12	1/2	0/36	5907558417807

Kompresor

Compressor / Kompessor / Компрессор / Компресор / Kompressor / Compresor / Kompresor / Kompresor / Kompresorius / Kompresors / Kompresor / Компресор / Kompresor / Kompresor / Συμπιεστής / Compresor / Compresore / Compresor / Compresseur / Compresor

NEO TOOLS



NEO TOOLS



NEO TOOLS

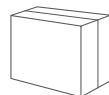

Ref.	⊠	EAN
12K020	0/1	5907558453676

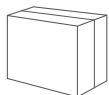

Ref.	⊠	EAN
12K021	0/1	5907558453683

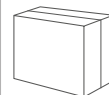

Ref.	⊠	EAN
12K022	0/1	5907558453690

Kompresor olejowy

Compressor - lubricated / Ölkompressor / Компрессор масляный / Компресор олійний / Kompreszor / Compressor cu ulei / Olejový kompresor / Kompresor / Oljní kompresor / Tepalínis kompresorius / Είλας kompresors / Kompresor (märitud) / Компресор / Kompresor / Kompresor / Συμπιεστής υγραερίματος / Compressor de aceite / Compressore ad olio / Compressor de óleo / Compresseur à huile / Olie compressor /

NEO
TOOLS



Ref.	☒	EAN
12K030	0/1	5907558453706

NEO
TOOLS



Ref.	☒	EAN
12K031	0/1	5907558453713

NEO
TOOLS



Ref.	☒	EAN
12K010	0/1	5907558439373

Naolejacz

Oiler / Ölgerät / Смазыватель / Оливорозпылювач / Olajozó pneumatikus / Gresor de ulei / Mazací jednotka / Olejovač / Lubrikator / Tepalíné / Ieeļotājs / Ūlītusseade / Смазвач / Nauljivač / Podmazivač / Ψεκαστήρας λαδιού / Lubrificador / Oliatore per utensili pneumatici / Máquina oleadora / Huileur / Smeertoestel

NEO
TOOLS



Ref.	☒	EAN
14-552	1/200	5907558444902

Pistolet do przedmuchiwania

Blowing gun / Pistole zum Durchblasen / Пистолет для продувания / Пистолет до продування / Pneumatikus lefúvatópisztoly / Pistol de baleiaj / Pistole pro profukování / Prefukovacia pištoľ / Izpihovna pištoľ / Prapūtimo pistoletas / Caurpūšanas pistole / Lābilputuspistol / Пистолет за продување / Pištoľ za ispuhivanje / Pištoľ za produnavanje / Πιστόλι αέρος / Pistola de limpieza a chorro de aire / Pistola aria compressa / Pistola para soprar / Pistolet de soufflage / Afblaaspistool

NEO
TOOLS

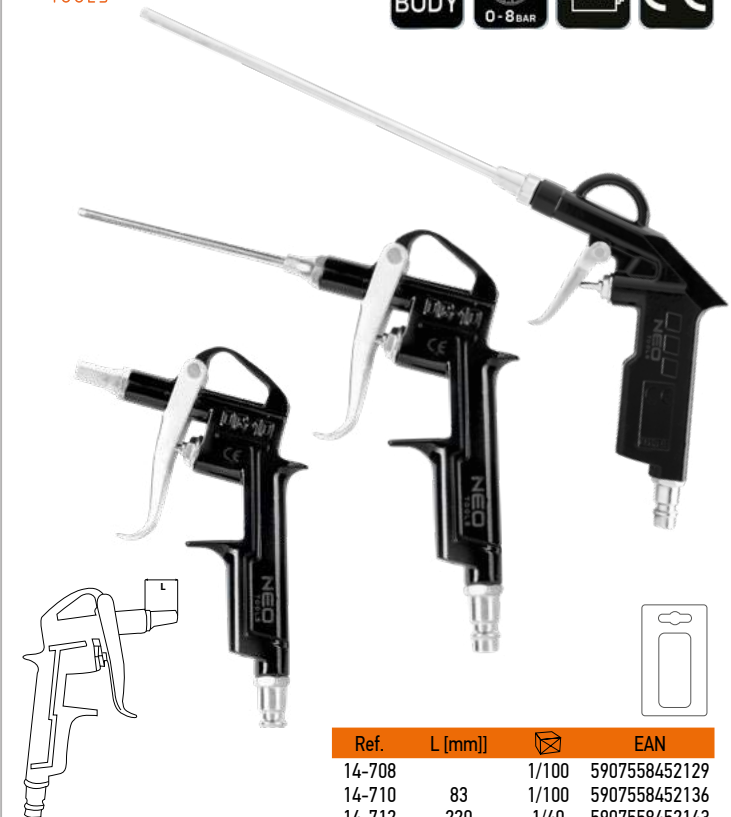

Ref.	L [mm]	☒	EAN
14-708		1/100	5907558452129
14-710	83	1/100	5907558452136
14-712	220	1/40	5907558452143

Zestaw lakierniczy

Lacquer set / Lackierset / Набор для лакирования / Комплект до лакофарбувальних робіт / Kompreszor tartozékészlet / Garnitură de lăcuit / Lakovací sada / Súprava na lakovanie / Komplet za lakiranje / Komplektas dažytojų / Laku komplekts / Lakkimiskomplekt / Комплект за лакиране / Set za lakiranje / Pribor za lakiranje / Σετ βερνικώματος / Juego de herramientas para barnizado / Pistola a spruzzo in kit / Kit p. Verniz / Jeu d'outils de peinture / Lakset

NEO
TOOLS



Ref.	☒	EAN
14-699	1/10	5907558452068

Pistolet natryskowy

Spray gun / Sprühpistole / Пистолет-распылитель / Φαρβουλήτ / Festékszóró pisztoly / Pistol de duș / Stříkací pistole / Striekacia pištoľ / Brizgalna pištola / Purškimo pistoletas / Pistole-smidzinātājs / Pihustuspüstol / Пистолет - нупееруагор / Pištoľ za prskanje / Pištoľ za prskanje / Πιστόλι ψεκασμού / Pistola de aspersiön / Pistola a spruzzo / Pistola de borifjar / Pistolet à projection / Spuitpistool

NEO
TOOLS



Ref. 14-700
EAN 5907558452075

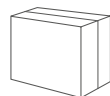

NEO
TOOLS



Ref. 14-702
EAN 5907558452082

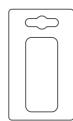

NEO
TOOLS



Ref. 14-703
EAN 5907558452099

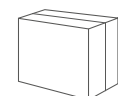

NEO
TOOLS



Ref. 14-704
EAN 5907558452105

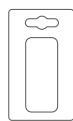

Pistolet do mycia

Washing gun / Reinigungspistole / Пистолет-распылитель для мытья / Пистолет для мытья / Alváztvédő szórópisztoly / Pistol de spălat / Pistole na mytí / Čistiaca pištoľ / Pištola za pranje / Plovimo pistoletas / Mazgāšanas pistole / Pesemispüstol / Пистолет за миене / Pištoľ za pranje / Pištoľ za pranje / Πιστόλι πλύσης / Pistola de limpiar / Pistola per pulizia / Pistola p. Limpeza / Pistolet de lavage / Waspistool

NEO
TOOLS



Ref. 14-706
EAN 5907558452112

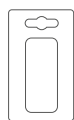

Pistolet do konserwacji

Maintenance gun / Wartungspistole / Антнкоррозиийный пистолет со шлангом / Φαρβουλήτ / Alváztvédő szórópisztoly tömlővel / Pistol de conservare / Pistole pro údržbu / Konzervačná pištoľ / Pištola za nanašanje zaštite / Oro išsiurbimo pistoletas / Konservācijas pistole / Hoolduspüstol / Пистолет за нонсервация / Pištoľ za održavanje / Pištoľ za konzerviranje / Πιστόλι ψεκασμού για συντήρηση / Pistola de conservación / Pistola per rivestimenti / Pistola p. Conservação / Pistolet d'entretien / Onderhoudspistool

NEO
TOOLS



Ref. 14-720
EAN 5907558452181

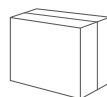

Pistolet do piaskowania

Sandblasting gun / Pistole zum Sandstrahlen / Пескоструйный пистолет с бачком / Пістолет до піскоструменевої обробки / Homokfúvó pisztoly tartállyal / Pistol de sablare / Pískovací pistole / Pieskováca pištoľ / Pištoľ za peskanje / Smėliavimo pistoletas / Smilšstrūkløšanas pistole / Liivaprits / Пистолет за масно / Pištoľ za pjskarenje / Pištoľ za peskarenje / Πιστόλι αμμοβολής / Pistolas de decapado por arena / Pistola per sabbatura / Pistola p. Areia / Pistolet à sablage / Zandblaaspistool

NEO
TOOLS



ALU
BODY

1L

CE

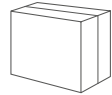

Ref.	☒	EAN
14-724	1/10	5907558452204

NEO
TOOLS



MAX 8 BAR

0.5-6.8
l/min

L/MIN
125

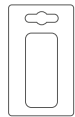

Ref.	☒	EAN
14-722	0/40	5907558452198

Piasek

Sand / Sand / Песок / Писок / Ásványhomok homokfúvóshoz / Nisip / Pisek / Piesok / Pesek / Dirželis / Smiltis / Zarnelē rutravitumi / Saurulīte sūkņēšanai / Рутбановлік / Маркуч за напомене / Сријево за рупрање / Crevo за рупрање / Εύκαμπτος σωλήνας πιστολιού / Manguera para bombear / Tubo di gonfiaggio / Mangueira p. bombar / Flexible de pompage / Pompslang

NEO
TOOLS



Ø
0,1-0,5
mm

Ref.	m [kg]	☒	EAN
12-562	1	0/20	5907558417586
12-564	10	0/2	5907558417593

Wężyk do pompowania

Hose for inflating gun / Schlauch zum Pumpen / Шланг к пистолету / Шланг до пістолету / Kerékfúvató tömlő / Furtun pentru pistol de pompare / Hadička na pumpaní / Hadička na pumpanie / Cev za črpanje / Zarnelē rutravitumi / Saurulīte sūkņēšanai / Рутбановлік / Маркуч за напомене / Сријево за рупрање / Crevo за рупрање / Εύκαμπτος σωλήνας πιστολιού / Manguera para bombear / Tubo di gonfiaggio / Mangueira p. bombar / Flexible de pompage / Pompslang

NEO
TOOLS



Ref.	L [mm]	☒	EAN
14-820	400	0/100	5907558452280

Pistolet do pompowania

Inflating gun / Pumpenpistole / Пистолет для подкачки шин / Пістолет до помпування / Kerékfúvató pisztoly nyomásmérővel / Pistol de pompare / umflare / Plnići pistole / Pumpovací pištoľ / Pištoľ za črpanje / Siurbimo pistoletas / Sūkņēšanas pistole / Püstoľpump / Пистолет за изпомпване / Pištoľ za rупranje / Pištoľ za rупranje / Πιστόλι φουσκώματος ελαστικών / Pistola para inflar / Gonfiatore per pneumatici / Pistola p. Bomba / Pistolet de pompage / Pomppistool

NEO
TOOLS



ALU
BODY

370mm

max 8 BAR

63mm

FILTER

CE

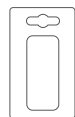

Ref.	☒	EAN
14-714	1/40	5907558452150

NEO
TOOLS



ALU
BODY

300mm

max 12 BAR

FILTER

CE

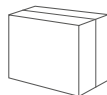

Ref.	☒	EAN
14-716	1/20	5907558452167

NEO
TOOLS



0-12
bar

80mm

MAX 8 BAR

440mm

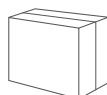

Ref.	☒	EAN
14-718	0/20	5907558452174



BHP
OHS CM3



Spodnie robocze

Working trousers / Arbeitshose / Брюки рабочие / Штаны рабочие / Munkdžszeki / Pantaloni de lucru / Pracovní kalhoty / Montérky / Delovne hlače / Darbinės kelnės / Darba bikses / Тööpüksid / Работни панталони / Radne hlače / Radne pantalone / Παντελόνι εργασίας / Pantalón de trabajo / Pantaloni da lavoro / Calças de trabalho / Pantalon de travail salopette / Tuinbroek

NEO
TOOLS



Ref.	Size	☒	EAN
80-220-S	S/36	0/24	5907558434330
80-220-M	M/38	0/24	5907558434347
80-220-L	L/40	0/24	5907558434354
80-220-XL	XL/42	0/24	5907558434361
80-220-XXL	XXL/44	0/24	5907558434378

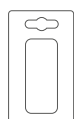

NEO
TOOLS



Ref.	Size	☒	EAN
81-226-XS	XS/46	12/24	5907558446654
81-226-S	S/48	12/24	5907558446661
81-226-M	M/50	12/24	5907558446678
81-226-L	L/52	12/24	5907558446685
81-226-XL	XL/54	12/24	5907558446692
81-226-XXL	XXL/56	12/24	5907558446708
81-226-XXXL	XXXL/58	12/24	5907558446715

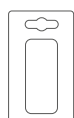

NEO
TOOLS



Możliwość połączenia z bluzą roboczą 81-217 w kombinezon (wewnętrzny suwak)
Could be matched with jacket 81-217 into jumpsuit by zipper on elastic inner panel
Можно комбинировать с блузой рабочей 81-217 в кombineзон (пояс на резинке на молнии внутри)

Ref.	Size	☒	EAN
81-227-XS	XS/46	0/24	5907558446937
81-227-S	S/48	0/24	5907558446944
81-227-M	M/50	0/24	5907558446951
81-227-L	L/52	0/24	5907558446968
81-227-XL	XL/54	0/24	5907558446975
81-227-XXL	XXL/56	0/24	5907558446982
81-227-XXXL	XXXL/58	0/24	5907558446999

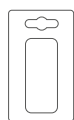

Spodnie robocze ogrodniczki

Working dungarees / Arbeitslatzhose / Полукombineзон / Неполнокомбeзон / Munkaruha - kertész nadrág / Pantaloni de lucru cu pieptar / Pracovní kalhoty s laclm / Pracovné pohavice do záhrady / Delovne hlače / Darbinės kelnės (sodininkams) / Dārzniecēs darba bikses / Τότουνked / Градинарски работен панталон / Radne hlače na tregeru / Pantalone za rad u vrtu / Φάρμα εργασίας με τράντες / Pantalón de trabajo tipo mono / Calças de trabalho / Pantalon de travail salopette / Tuinbroek

NEO
TOOLS



Ref.	Size	☒	EAN
80-240-S	S/36	0/24	5907558434385
80-240-M	M/38	0/24	5907558434392
80-240-L	L/40	0/24	5907558434408
80-240-XL	XL/42	0/24	5907558434415
80-240-XXL	XXL/44	0/24	5907558434422

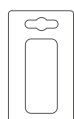

finalist
of the competition



2019

NEO
TOOLS



Ref.	Size	☒	EAN
81-246-XS	XS/46	0/15	5907558446722
81-246-S	S/48	0/15	5907558446739
81-246-M	M/50	0/15	5907558446746
81-246-L	L/52	0/15	5907558446753
81-246-XL	XL/54	0/15	5907558446760
81-246-XXL	XXL/56	0/15	5907558446777
81-246-XXXL	XXXL/58	0/15	5907558446784

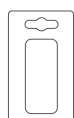

NEO
TOOLS



Ref.	Size	☒	EAN
81-247-XS	XS/46	0/20	5907558447002
81-247-S	S/48	0/20	5907558447019
81-247-M	M/50	0/20	5907558447026
81-247-L	L/52	0/20	5907558447033
81-247-XL	XL/54	0/20	5907558447040
81-247-XXL	XXL/56	0/20	5907558447057
81-247-XXXL	XXXL/58	0/20	5907558447064

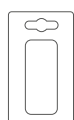

Spodnie robocze

Working trousers / Arbeitshose / Брюки рабочие / Штаны рабочие / Munkadzseki / Pantaloni de lucru / Pracovní kalhoty / Montérky / Delovne hlače / Darbinės kelnės / Darba bikses / Tööpüksid / Работни панталони / Radne hlače / Radne pantalone / Παντελόνι εργασίας / Pantalón de trabajo / Pantaloni da lavoro / Calças de trabalho / Pantalon de travail

NEO
TOOLS



Ref.	Size	⊠	EAN
81-223-XS	XS/46	12/24	5907558443097
81-223-S	S/48	12/24	5907558443103
81-223-M	M/50	12/24	5907558443110
81-223-L	L/52	12/24	5907558443127
81-223-XL	XL/54	12/24	5907558443134
81-223-XXL	XXL/56	12/24	5907558443141
81-223-XXXL	XXXL/58	12/24	5907558443158

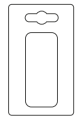

NEO
TOOLS



Ref.	Size	⊠	EAN
81-221-XS	XS/46	12/24	5907558441970
81-221-S	S/48	12/24	5907558434897
81-221-M	M/50	12/24	5907558434903
81-221-L	L/52	12/24	5907558434910
81-221-XL	XL/54	12/24	5907558434927
81-221-XXL	XXL/56	12/24	5907558434934
81-221-XXXL	XXXL/58	12/24	5907558441987

NEO
TOOLS

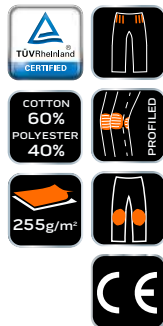

Ref.	Size	⊠	EAN
81-222-XS	XS/46	12/24	5907558441994
81-222-S	S/48	12/24	5907558434941
81-222-M	M/50	12/24	5907558434958
81-222-L	L/52	12/24	5907558434965
81-222-XL	XL/54	12/24	5907558434972
81-222-XXL	XXL/56	12/24	5907558434989
81-222-XXXL	XXXL/58	12/24	5907558442007

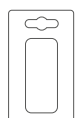

Spodnie robocze ogrodniczki

Working dungarees / Arbeitslatzhose / Полукомбинезон / Наніюмбінезон / Munkaruha - kertész nadrág / Pantaloni de lucru cu pieptar / Pracovní kalhoty s lacem / Pracovné pohavice do záhrady / Delovne hlače / Darbinės kelnės (sodininkams) / Dārzniecēs darba bikses / Töödunked / Градинарски работен панталон / Radne hlače na tregeru / Pantalone za rad u vrtu / Φόρμα εργασίας με τράντες / Pantalón de trabajo tipo mono // Calças de trabalho / Pantalon de travail salopette / Tuinbroek

NEO
TOOLS

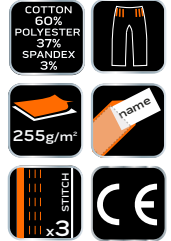

Ref.	Size	⊠	EAN
81-243-XS	XS/46	10/20	5907558443165
81-243-S	S/48	10/20	5907558443172
81-243-M	M/50	10/20	5907558443189
81-243-L	L/52	10/20	5907558443196
81-243-XL	XL/54	10/20	5907558443202
81-243-XXL	XXL/56	10/20	5907558443219
81-243-XXXL	XXXL/58	10/20	5907558443226

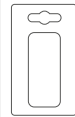

NEO
TOOLS



Ref.	Size	⊠	EAN
81-241-XS	XS/46	10/20	5907558442014
81-241-S	S/48	10/20	5907558434996
81-241-M	M/50	10/20	5907558435009
81-241-L	L/52	10/20	5907558435016
81-241-XL	XL/54	10/20	5907558435023
81-241-XXL	XXL/56	10/20	5907558435030
81-241-XXXL	XXXL/58	10/20	5907558442021

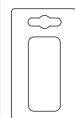

NEO
TOOLS



Ref.	Size	⊠	EAN
81-242-XS	XS/46	10/20	5907558442038
81-242-S	S/48	10/20	5907558435047
81-242-M	M/50	10/20	5907558435054
81-242-L	L/52	10/20	5907558435061
81-242-XL	XL/54	10/20	5907558435078
81-242-XXL	XXL/56	10/20	5907558435085
81-242-XXXL	XXXL/58	10/20	5907558442045

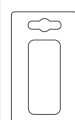

Spodnie robocze

Working trousers / Arbeitshose / Брюки рабочие / Штани робочі / Munkadzseki / Pantaloni de lucru / Pracovní kalhoty / Montérky / Delovne hlače / Darbinės kelnės / Darba bikses / Тööpüksid / Работни панталони / Radne hlače / Radne pantalone / Παντελόνι εργασίας / Pantalón de trabajo / Pantaloni da lavoro / Calças de trabalho / Pantalon de travail

NEO
TOOLS



Ref.	Size	☒	EAN
81-224-XS	XS/46	12/24	5907558444001
81-224-S	S/48	12/24	5907558444018
81-224-M	M/50	12/24	5907558444025
81-224-L	L/52	12/24	5907558444032
81-224-XL	XL/54	12/24	5907558444049
81-224-XXL	XXL/56	12/24	5907558444056
81-224-XXXL	XXXL/58	12/24	5907558444063

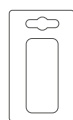

NEO
TOOLS



Ref.	Size	☒	EAN
81-225-S	S/48	0/20	5907558435146
81-225-M	M/50	0/20	5907558435153
81-225-L	L/52	0/20	5907558435160
81-225-XL	XL/54	0/20	5907558435177
81-225-XXL	XXL/56	0/20	5907558435184

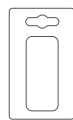

NEO
TOOLS



Ref.	Size	☒	EAN
81-120-S	S/48	0/10	5902062018182
81-120-M	M/50	0/10	5902062018199
81-120-L	L/52	0/10	5902062018205
81-120-LD	L/54	0/10	5902062018212
81-120-XL	XL/56	0/10	5902062018229
81-120-XXL	XXL/58	0/10	5902062018236

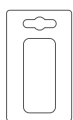

Spodnie robocze ogrodniczki

Working dungarees / Arbeitslatzhose / Полукомбинезон / Нاپівкомбінезон / Munkaruha - kertész nadrág / Pantaloni de lucru cu pieptar / Pracovní kalhoty s lacem / Pracovné nohavice do záhrady / Delovne hlače / Darbinės kelnės (sodininkams) / Dārznieces darba bikses / Тöötunked / Градинарски работен панталон / Radne hlače na tregeru / Pantalone za rad u vrtu / Φόρμα εργασίας με τράντες / Pantalón de trabajo tipo mono // Calças de trabalho / Pantalon de travail salopette / Tuinbroek

NEO
TOOLS



Ref.	Size	☒	EAN
81-244-XS	XS/46	10/20	5907558444070
81-244-S	S/48	10/20	5907558444087
81-244-M	M/50	10/20	5907558444094
81-244-L	L/52	10/20	5907558444100
81-244-XL	XL/54	10/20	5907558444117
81-244-XXL	XXL/56	10/20	5907558444124
81-244-XXXL	XXXL/58	10/20	5907558444131

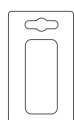

NEO
TOOLS



Ref.	Size	☒	EAN
81-245-S	S/48	10/20	5907558435191
81-245-M	M/50	10/20	5907558435207
81-245-L	L/52	10/20	5907558435214
81-245-XL	XL/54	10/20	5907558435221
81-245-XXL	XXL/56	10/20	5907558435238

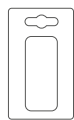

NEO
TOOLS



Ref.	Size	☒	EAN
81-140-S	S/48	0/10	5902062018243
81-140-M	M/50	0/10	5902062018250
81-140-L	L/52	0/10	5902062018267
81-140-LD	L/54	0/10	5902062018274
81-140-XL	XL/56	0/10	5902062018281
81-140-XXL	XXL/58	0/10	5902062018298

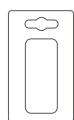

Spodnie robocze ogrodniczki

Working dungarees / Arbeitslatzhose / Полукомбинезон / Ханіакомбінезон / Munkaruha - kertész nadrág / Pantaloni de lucru cu pieptar / Pracovní kalhoty s laclm / Pracovné nohavice do záhrady / Delovne hlače / Darbinės kelnės (sodininkams) / Dārznieces darba bikses / Töötunked / Градинарски работен панталон / Radne hlače na treger / Pantalone za rad u vrtu / Φόρμα εργασίας με πλάτες / Pantalón de trabajo tipo mono // Calças de trabalho / Pantalon de travail salopette / Tuinbroek

NEO
TOOLS



Ref.	Size	☒	EAN
81-248-XS	XS/46	0/20	5907558451795
81-248-S	S/48	0/20	5907558451801
81-248-M	M/50	0/20	5907558451818
81-248-L	L/52	0/20	5907558451825
81-248-XL	XL/54	0/20	5907558451832
81-248-XXL	XXL/56	0/20	5907558451849
81-248-XXXL	XXXL/58	0/20	5907558451856

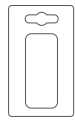

NEO
TOOLS



Ref.	Size	☒	EAN
81-430-S	S/48	0/10	5907558415506
81-430-M	M/50	0/10	5907558415513
81-430-L	L/52	0/10	5907558415520
81-430-LD	L/54	0/10	5907558415537
81-430-XL	XL/56	0/10	5907558415544
81-430-XXL	XXL/58	0/10	5907558415551

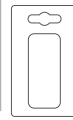

Spodnie robocze

Working trousers / Arbeitshose / Брюки рабочие / Штаны рабочие / Munkadzseki / Pantaloni de lucru / Pracovní kalhoty / Montérky / Delovne hlače / Darbinės kelnės / Darba bikses / Tööpüksid / Работни панталони / Radne hlače / Radne pantalone / Παντελόνι εργασίας / Pantalón de trabajo / Pantaloni da lavoro / Calças de trabalho / Pantalon de travail

NEO
TOOLS



Ref.	Size	☒	EAN
81-239-XS	XS/46	0/20	5907558451726
81-239-S	S/48	0/20	5907558451733
81-239-M	M/50	0/20	5907558451740
81-239-L	L/52	0/20	5907558451757
81-239-XL	XL/54	0/20	5907558451764
81-239-XXL	XXL/56	0/20	5907558451771
81-239-XXXL	XXXL/58	0/20	5907558451788



NEO
TOOLS



Ref.	Size	☒	EAN
81-420-S	S/48	0/10	5907558415445
81-420-M	M/50	0/10	5907558415452
81-420-L	L/52	0/10	5907558415469
81-420-LD	L/54	0/10	5907558415476
81-420-XL	XL/56	0/10	5907558415483
81-420-XXL	XXL/58	0/10	5907558415490

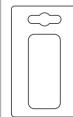

NEO
TOOLS



Ref.	Size	☒	EAN
81-238-XS	XS/46	0/20	5907558451658
81-238-S	S/48	0/20	5907558451665
81-238-M	M/50	0/20	5907558451672
81-238-L	L/52	0/20	5907558451689
81-238-XL	XL/54	0/20	5907558451696
81-238-XXL	XXL/56	0/20	5907558451702
81-238-XXXL	XXXL/58	0/20	5907558451719

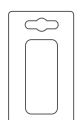

NEO
TOOLS



Ref.	Size	☒	EAN
81-231-XS	XS/46	0/20	5907558447071
81-231-S	S/48	0/20	5907558447088
81-231-M	M/50	0/20	5907558447095
81-231-L	L/52	0/20	5907558447101
81-231-XL	XL/54	0/20	5907558447118
81-231-XXL	XXL/56	0/20	5907558447125
81-231-XXXL	XXXL/58	0/20	5907558447132

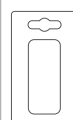

Spodnie robocze

Working trousers / Arbeitshose / Брюки рабочие / Штани робочі / Munkadzseki / Pantaloni de lucru / Pracovní kalhoty / Montérky / Delovne hlače / Darbinės kelnės / Darba bikses / Tööpüksid / Работни панталони / Radne hlače / Radne pantalone / Παντελόνι εργασίας / Pantalón de trabajo / Pantaloni da lavoro / Calças de trabalho / Pantalon de travail

NEO
TOOLS



Ref.	Size	☒	EAN
81-220-S	S/48	0/10	5907558419085
81-220-M	M/50	0/10	5907558419092
81-220-L	L/52	0/10	5907558419108
81-220-LD	L/54	0/10	5907558419115
81-220-XL	XL/56	0/10	5907558419122
81-220-XXL	XXL/58	0/10	5907558419139

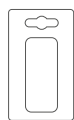

NEO
TOOLS

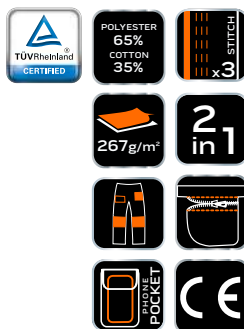

Ref.	Size	☒	EAN
81-230-S	S/48	0/10	5907558419146
81-230-M	M/50	0/10	5907558419153
81-230-L	L/52	0/10	5907558419160
81-230-LD	L/54	0/10	5907558419177
81-230-XL	XL/56	0/10	5907558419184
81-230-XXL	XXL/58	0/10	5907558419191

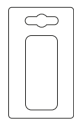

NEO
TOOLS



Ref.	Size	☒	EAN
81-325-XS	XS/46	0/20	5907558453126
81-325-S	S/48	0/20	5907558453133
81-325-M	M/50	0/20	5907558453140
81-325-L	L/52	0/20	5907558453157
81-325-XL	XL/54	0/20	5907558453164
81-325-XXL	XXL/56	0/20	5907558453171
81-325-XXXL	XXXL/58	0/20	5907558453188

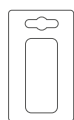

Spodnie robocze na szelkach

Working trousers with suspenders / Arbeitslatzhose / Полумкомбінезон робочий / Півкомбінезон робочий / Kantáros munkanadrág / Pantaloni de lucru cu bretele / Montérkové kalhoty / Montérky na traky / Delovne hlače z naramnicami / Darbinės kelnės su petnešomis / Darba puskombinezons / Traksideda tööpüksid / Работни панталони с тирантми / Radne farmer hlače / Radne pantalone sa tregerima / Φόρμα εργασίας πράντα / Pantalón de trabajo con tirantes / Salopette da lavoro / Jardineiras de trabalho / Pantalon de travail sur bretelles

NEO
TOOLS



Ref.	Size	☒	EAN
81-240-S	S/48	0/10	5907558419207
81-240-M	M/50	0/10	5907558419214
81-240-L	L/52	0/10	5907558419221
81-240-LD	L/54	0/10	5907558419238
81-240-XL	XL/56	0/10	5907558419245
81-240-XXL	XXL/58	0/10	5907558419252

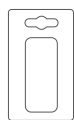

NEO
TOOLS



Ref.	Size	☒	EAN
81-320-S	S/48	0/10	5907558419436
81-320-M	M/50	0/10	5907558419443
81-320-L	L/52	0/10	5907558419450
81-320-LD	L/54	0/10	5907558419467
81-320-XL	XL/56	0/10	5907558419474
81-320-XXL	XXL/58	0/10	5907558419481

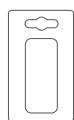

NEO
TOOLS



Ref.	Size	☒	EAN
81-321-XS	XS/46	0/20	5907558453058
81-321-S	S/48	0/20	5907558453065
81-321-M	M/50	0/20	5907558453072
81-321-L	L/52	0/20	5907558453089
81-321-XL	XL/54	0/20	5907558453096
81-321-XXL	XXL/56	0/20	5907558453102
81-321-XXXL	XXXL/58	0/20	5907558453119

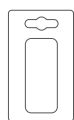

Spodnie robocze

Working trousers / Arbeitshose / Брюки рабочие / Штаны робочі / Munkadzseki / Pantaloni de lucru / Pracovní kalhoty / Montérky / Delovne hlače / Darbinės kelnės / Darba bikses / Tööpüksid / Работни панталони / Radne hlače / Radne pantalone / Παντελόνι εργασίας / Pantalón de trabajo / Pantaloni da lavoro / Calças de trabalho / Pantalon de travail

NEO
TOOLS



finalist
of the competition



2020

Ref.	Size	☒	EAN
81-229-XS	XS/46	0/20	5907558439496
81-229-S	S/48	0/20	5907558439502
81-229-M	M/50	0/20	5907558439519
81-229-L	L/52	0/20	5907558443127
81-229-XL	XL/54	0/20	5907558443134
81-229-XXL	XXL/56	0/20	5907558439540
81-229-XXXL	XXXL/58	0/20	5907558439557

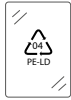

NEO
TOOLS



Ref.	Size	☒	EAN
81-228-XS	XS/46	0/20	5907558439427
81-228-S	S/48	0/20	5907558439434
81-228-M	M/50	0/20	5907558439441
81-228-L	L/52	0/20	5907558439458
81-228-XL	XL/54	0/20	5907558439465
81-228-XXL	XXL/56	0/20	5907558439472
81-228-XXXL	XXXL/58	0/20	5907558439489

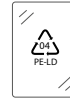

NEO
TOOLS

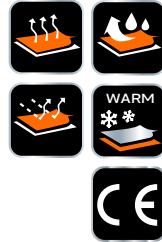

Ref.	Size	☒	EAN
81-566-S	S/48	0/20	5907558428186
81-566-M	M/50	0/20	5907558428193
81-566-L	L/52	0/20	5907558428209
81-566-XL	XL/56	0/20	5907558428216
81-566-XXL	XXL/58	0/20	5907558428223
81-566-XXXL	XXXL/60	0/20	5907558428230

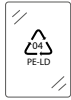

NEO
TOOLS



Ref.	Size	☒	EAN
81-565-S	S/48	0/10	5907558428247
81-565-M	M/50	0/10	5907558428254
81-565-L	L/52	0/10	5907558428261
81-565-XL	XL/56	0/10	5907558428278
81-565-XXL	XXL/58	0/10	5907558428285
81-565-XXXL	XXXL/60	0/10	5907558428292

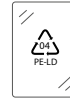

Kombinezon roboczy

Working overalls / Arbeitsoverall / Комбинезон рабочий / Комбинезон робочий / Overall / Combinezon de lucru / Pracovní kombinéza / Pracovní kombinéza / Delovni kombinezon / Darbinis kombinezonas / Darba kombinezons / Töökombinesoon / Работен комбинезон / Radni kombinezon / Radni kombinezon / Όρθρα εργασίας / Mono de trabajo / Tuta da lavoro / Macacão de trabalho / Combinaison de travail

NEO
TOOLS



Ref.	Size	☒	EAN
81-258-XS	XS/46	0/15	5907558451863
81-258-S	S/48	0/15	5907558451870
81-258-M	M/50	0/15	5907558451887
81-258-L	L/52	0/15	5907558451894
81-258-XL	XL/54	0/15	5907558451900
81-258-XXL	XXL/56	0/15	5907558451917
81-258-XXXL	XXXL/58	0/15	5907558451924

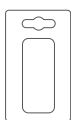

NEO
TOOLS



Ref.	Size	☒	EAN
81-250-S	S/48	0/10	5907558419269
81-250-M	M/50	0/10	5907558419276
81-250-L	L/52	0/10	5907558419283
81-250-LD	L/54	0/10	5907558419290
81-250-XL	XL/56	0/10	5907558419306
81-250-XXL	XXL/58	0/10	5907558419313

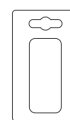

Spodnie przeciwdeszczowe

Rainproof trousers / Regenhose / Брюки влагозащитные / Штаны дощові / Esővédő nadrág / Pantaloni de ploaie / Kalhoty do deště / Nepremokavé nohavice / Dežne hlače / Lietaus kelnės / Lietus bikses / Vihmapiüksid / Панталон против дождя / Hlače za zaštitu od kiše / Pantalone za zaštitu od kiše / Παντελόνι για προστασία από την υγρασία / Pantalones de lluvia / Pantaloni impermeabili / Calças impermeáveis / Pantalon de pluie / Regenbroek /

NEO
TOOLS



Ref.	Size	☒	EAN
81-811-M	M/50	0/20	5907558444292
81-811-L	L/52	0/20	5907558444308
81-811-XL	XL/54	0/20	5907558444315
81-811-XXL	XXL/56	0/20	5907558444322
81-811-XXXL	XXXL/58	0/20	5907558444339



Spodnie robocze na szelkach

Working trousers with suspenders / Arbeitslatzhose / Полукombineзон рабочий / Півкомбінезон робочий / Kantáros munkanadrág / Pantaloni de lucru cu bretele / Montérkové kalhoty / Montérky na traky / Delovne hlače z naramnicami / Darbinės kelnės su petnešomis / Darba puskombinezons / Traksidaga tööpiüksid / Работни панталони с тирами / Radne farmer hlače / Radne pantalone sa tregerima / Όθρια εργασίας πράντα / Pantalón de trabajo con tirantes / Salopette da lavoro / Jardineiras de trabalho / Pantalon de travail sur bretelles

NEO
TOOLS



Ref.	Size	☒	EAN
81-779-S	S/48	0/10	5907558430028
81-779-M	M/50	0/10	5907558430035
81-779-L	L/52	0/10	5907558430042
81-779-XL	XL/56	0/10	5907558430059
81-779-XXL	XXL/58	0/10	5907558430066



Spodnie robocze

Working trousers / Arbeitshose / Брюки рабочие / Штаны робочі / Munkadzseki / Pantaloni de lucru / Pracovní kalhoty / Montérky / Delovne hlače / Darbinės kelnės / Darba bikses / Tööpiüksid / Работни панталони / Radne hlače / Radne pantalone / Παντελόνι εργασίας / Pantalón de trabajo / Pantaloni da lavoro / Calças de trabalho / Pantalon de travail

NEO
TOOLS



Ref.	Size	☒	EAN
81-792-S	S/48	0/20	5902062062932
81-792-M	M/50	0/20	5902062062949
81-792-L	L/52	0/20	5902062062956
81-792-XL	XL/56	0/20	5902062062963
81-792-XXL	XXL/58	0/20	5902062062970
81-792-XXXL	XXXL/60	0/20	5902062062987



NEO
TOOLS



Ref.	Size	☒	EAN
81-750-S	S/48	0/20	5907558428513
81-750-M	M/50	0/20	5907558428520
81-750-L	L/52	0/20	5907558428537
81-750-XL	XL/56	0/20	5907558428544
81-750-XXL	XXL/58	0/20	5907558428551
81-750-XXXL	XXXL/60	0/20	5907558428568



NEO
TOOLS



Ref.	Size	☒	EAN
81-751-S	S/48	0/20	5907558429039
81-751-M	M/50	0/20	5907558429046
81-751-L	L/52	0/20	5907558429053
81-751-XL	XL/56	0/20	5907558429060
81-751-XXL	XXL/58	0/20	5907558429077
81-751-XXXL	XXXL/60	0/20	5907558429084



NEO
TOOLS



Ref.	Size	☒	EAN
81-760-S	S/48	0/10	5907558428575
81-760-M	M/50	0/10	5907558428582
81-760-L	L/52	0/10	5907558428599
81-760-XL	XL/56	0/10	5907558428605
81-760-XXL	XXL/58	0/10	5907558428612
81-760-XXXL	XXXL/60	0/10	5907558428629



Spodnie robocze

Working trousers / Arbeitshose / Брюки рабочие / Штани робочі / Munkadzseki / Pantaloni de lucru / Pracovní kalhoty / Montérky / Delovne hlače / Darbinės kelnės / Darba bikses / Tööpüksid / Работни панталони / Radne hlače / Radne pantalone / Παντελόνι εργασίας / Pantalón de trabajo / Pantaloni da lavoro / Calças de trabalho / Pantalon de travail

NEO
TOOLS



Ref.	Size	☒	EAN
81-761-S	S/48	0/10	5907558428971
81-761-M	M/50	0/10	5907558428988
81-761-L	L/52	0/10	5907558428995
81-761-XL	XL/56	0/10	5907558429008
81-761-XXL	XXL/58	0/10	5907558429015
81-761-XXXL	XXXL/60	0/10	5907558429022

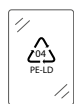

NEO
TOOLS



Ref.	Size	☒	EAN
81-770-S	S/48	0/10	5907558428636
81-770-M	M/50	0/10	5907558428643
81-770-L	L/52	0/10	5907558428650
81-770-XL	XL/56	0/10	5907558428667
81-770-XXL	XXL/58	0/10	5907558428674
81-770-XXXL	XXXL/60	0/10	5907558428681

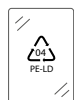

NEO
TOOLS



Ref.	Size	☒	EAN
81-771-S	S/48	0/10	5907558429152
81-771-M	M/50	0/10	5907558429169
81-771-L	L/52	0/10	5907558429176
81-771-XL	XL/56	0/10	5907558429183
81-771-XXL	XXL/58	0/10	5907558429190
81-771-XXXL	XXXL/60	0/10	5907558429206



Spodnie robocze na szelkach

Working trousers with suspenders / Arbeitslatzhose / Полукombineзон рабочий / Півкомбінезон рабочий / Kantáros munkanadrág / Pantaloni de lucru cu bretele / Montérkové kalhoty / Montérky na traky / Delovne hlače z naramnicami / Darbinės kelnės su petnešomis / Darba puskombinezons / Traksidaga tööpüksid / Работни панталону с тиражму / Radne farmer hlače / Radne pantalone sa tregerima / Φόρμα εργασίας πράντα / Pantalón de trabajo con tirantes / Salopette da lavoro / Jardineiras de trabalho / Pantalon de travail sur bretelles

NEO
TOOLS



Ref.	Size	☒	EAN
81-775-S	S/48	0/10	5907558429688
81-775-M	M/50	0/10	5907558429695
81-775-L	L/52	0/10	5907558429756
81-775-XL	XL/56	0/10	5907558429718
81-775-XXL	XXL/58	0/10	5907558429725

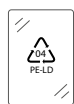

NEO
TOOLS



Ref.	Size	☒	EAN
81-776-S	S/48	0/10	5907558429732
81-776-M	M/50	0/10	5907558429749
81-776-L	L/52	0/10	5907558429756
81-776-XL	XL/56	0/10	5907558429763
81-776-XXL	XXL/58	0/10	5907558429770

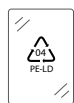

Spodnie robocze ogrodniczki

Working dungarees / Arbeitslatzhose / Полукombineзон / Навікомбінезон / Munkaruha - kertész nadrág / Pantaloni de lucru cu pieptar / Pracovní kalhoty s lácem / Pracovné pohavice do záhrady / Delovne hlače / Darbinės kelnės (sodininkams) / Dārznieces darba bikses / Töötunked / Градинарски работен панталон / Radne hlače na tregeru / Pantalone za rad u vrtu / Φόρμα εργασίας με τράντες / Pantalón de trabajo tipo mono // Calças de trabalho / Pantalon de travail salopette / Tuinbroek

NEO
TOOLS



Ref.	Size	☒	EAN
81-777-S	S/48	0/10	5907558429787
81-777-M	M/50	0/10	5907558429794
81-777-L	L/52	0/10	5907558429800
81-777-XL	XL/56	0/10	5907558429817
81-777-XXL	XXL/58	0/10	5907558429824



Spodnie robocze ogrodniczki

Working dungarees / Arbeitslatzhose / Полукombineзон / Непівкомбінезон / Munkaruha - kertész nadrág / Pantaloni de lucru cu pieptar / Pracovní kalhoty s lačlem / Pracovné nohavice do záhrady / Delovne hlače / Darbinės kelinės (sodininkams) / Dārznieces darba bikses / Töötunked / Градинарски работен панталон / Radne hlače na tregere / Pantalone za rad u vrtu / Φάρμα εργασίας με τράντες / Pantalón de trabajo tipo mono // Calças de trabalho / Pantalón de travail salopette / Tuinbroek

NEO
TOOLS



Ref.	Size	☒	EAN
81-778-S	S/48	0/10	5907558429831
81-778-M	M/50	0/10	5907558429848
81-778-L	L/52	0/10	5907558429855
81-778-XL	XL/56	0/10	5907558429862
81-778-XXL	XXL/58	0/10	5907558429879



Krótkie spodniki

Shorts / Kurzhose / Шорты / Коротки Штани / Rövidnadrág / Pantaloni Scurți / Kratasy / Krátke Nohavice / Krátke Hlače / Darbiniai Šortai / Šorti / Lühikesed Püksid / Късу Панталони / Krátke Hlače / Krátke Pantalone / Βερμούδες / Pantalones Cortos / Pantaloncini Corti / Calças Curtas / Culotte / Korte Broek

NEO
TOOLS



Ref.	Size	☒	EAN
81-276-XS	XS/46	0/24	5907558446791
81-276-S	S/48	0/24	5907558446807
81-276-M	M/50	0/24	5907558446814
81-276-L	L/52	0/24	5907558446821
81-276-XL	XL/54	0/24	5907558446838
81-276-XXL	XXL/56	0/24	5907558446845
81-276-XXXL	XXXL/58	0/24	5907558446852

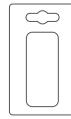

Krótkie spodniki

Shorts / Kurzhose / Шорты / Коротки Штани / Rövidnadrág / Pantaloni Scurți / Kratasy / Krátke Nohavice / Krátke Hlače / Darbiniai Šortai / Šorti / Lühikesed Püksid / Късу Панталони / Krátke Hlače / Krátke Pantalone / Βερμούδες / Pantalones Cortos / Pantaloncini Corti / Calças Curtas / Culotte / Korte Broek

NEO
TOOLS



Ref.	Size	☒	EAN
81-279-XS	XS/46	0/20	5907558439861
81-279-S	S/48	0/20	5907558439878
81-279-M	M/50	0/20	5907558439885
81-279-L	L/52	0/20	5907558439892
81-279-XL	XL/54	0/20	5907558439908
81-279-XXL	XXL/56	0/20	5907558439915
81-279-XXXL	XXXL/58	0/20	5907558439922



NEO
TOOLS



Ref.	Size	☒	EAN
81-271-XS	XS/46	16/32	5907558442410
81-271-S	S/48	16/32	5907558442427
81-271-M	M/50	16/32	5907558442434
81-271-L	L/52	16/32	5907558442441
81-271-XL	XL/54	16/32	5907558442458
81-271-XXL	XXL/56	16/32	5907558442465
81-271-XXXL	XXXL/58	16/32	5907558442472

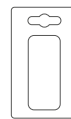

NEO
TOOLS



Ref.	Size	☒	EAN
81-278-XS	XS/46	0/20	5907558451993
81-278-S	S/48	0/20	5907558452006
81-278-M	M/50	0/20	5907558452013
81-278-L	L/52	0/20	5907558452020
81-278-XL	XL/54	0/20	5907558452037
81-278-XXL	XXL/56	0/20	5907558452044
81-278-XXXL	XXXL/58	0/20	5907558452051

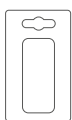

NEO
TOOLS



Ref.	Size	☒	EAN
81-270-S	S/48	0/10	5907558426595
81-270-M	M/50	0/10	5907558426601
81-270-L	L/52	0/10	5907558426618
81-270-LD	LD/54	0/10	5907558427066
81-270-XL	XL/56	0/10	5907558426625
81-270-XXL	XXL/58	0/10	5907558426632

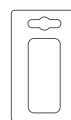

Krótkie spodniki

Shorts / Kurzhose / Шорты / Κορτοκι Σημανη / Rövidnadrág / Pantaloni Scurți / Krátasy / Krátke Nohavice / Kratke Hlače / Darbiniai Šortai / Šorti / Lühikesed Püksid / Къси Панталонки / Kratke Hlače / Kratke Pantalone / Βερμούδες / Pantalones Cortos / Pantaloncini Corti / Calças Curtas / Culotte / Korte Broek

NEO
TOOLS



Ref.	Size	☒	EAN
81-330-S	S/48	0/10	5907558426649
81-330-M	M/50	0/10	5907558426656
81-330-L	L/52	0/10	5907558426663
81-330-LD	LD/54	0/10	5907558427073
81-330-XL	XL/56	0/10	5907558426670
81-330-XXL	XXL/58	0/10	5907558426687

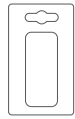

NEO
TOOLS



Ref.	Size	☒	EAN
81-440-S	S/48	0/10	5907558426694
81-440-M	M/50	0/10	5907558426700
81-440-L	L/52	0/10	5907558426717
81-440-LD	LD/54	0/10	5907558427080
81-440-XL	XL/56	0/10	5907558426724
81-440-XXL	XXL/58	0/10	5907558426731

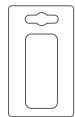

NEO
TOOLS



Ref.	Size	☒	EAN
81-781-S	S/48	0/20	5907558429633
81-781-M	M/50	0/20	5907558429640
81-781-L	L/52	0/20	5907558429657
81-781-XL	XL/56	0/20	5907558429664
81-781-XXL	XXL/58	0/20	5907558429671

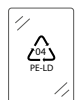

NEO
TOOLS



Ref.	Size	☒	EAN
81-331-XS	XS/46	0/20	5907558453195
81-331-S	S/48	0/20	5907558453201
81-331-M	M/50	0/20	5907558453218
81-331-L	L/52	0/20	5907558453225
81-331-XL	XL/54	0/20	5907558453232
81-331-XXL	XXL/56	0/20	5907558453249
81-331-XXXL	XXXL/58	0/20	5907558453256

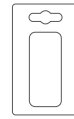

NEO
TOOLS



Ref.	Size	☒	EAN
81-780-S	S/48	0/20	5907558429589
81-780-M	M/50	0/20	5907558429596
81-780-L	L/52	0/20	5907558429602
81-780-XL	XL/56	0/20	5907558429619
81-780-XXL	XXL/58	0/20	5907558429626

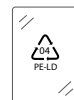

NEO
TOOLS



Ref.	Size	☒	EAN
81-782-S	S/48	0/50	5907558429923
81-782-M	M/50	0/50	5907558429930
81-782-L	L/52	0/50	5907558429947
81-782-XL	XL/56	0/50	5907558429954
81-782-XXL	XXL/58	0/50	5907558429961

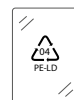

Krótkie spodenki

Shorts / Kurz hose / Шорты / Коротки Штаны / Rövid nadrág / Pantaloni Scurți / Kratasy / Krátke Nohavice / Kratke Hlače / Darbiniai Šortai / Sorti / Lühikesed Püksid / Кусы Панталоны / Kratke Hlače / Kratke Pantalone / Βερμούδες / Pantalones Cortos / Pantaloncini Corti / Calças Curtas / Culotte / Korte Broek

NEO
TOOLS



Ref.	Size	☒	EAN
81-783-S	S/48	0/50	5907558429978
81-783-M	M/50	0/50	5907558429985
81-783-L	L/52	0/50	5907558429992
81-783-XL	XL/56	0/50	5907558430004
81-783-XXL	XXL/58	0/50	5907558430011



Bluza robocza

Working top / Arbeitsshirt / Блуза рабочая / Куртка рабочая / Munkadzseki / Blusa de lucru / Pracovní blůza / Pracovná bunda / Delovna jakna / Darbiniai marškiniai / Darba kreklis / Töjakk / Работна блуза / Radna bluza / Radna bluza / Μηλούτζα εργασίας / Sudadera de trabajo / Giacca da lavoro / Blusão de trabalho / Veste de travail

NEO
TOOLS



Ref.	Size	☒	EAN
81-216-S	S/48	0/20	5907558446593
81-216-M	M/50	0/20	5907558446609
81-216-L	L/52	0/20	5907558446616
81-216-XL	XL/54	0/20	5907558446623
81-216-XXL	XXL/56	0/20	5907558446630
81-216-XXXL	XXXL/58	0/20	5907558446647

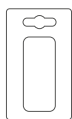

Bluza robocza

Working top / Arbeitsshirt / Блуза рабочая / Куртка рабочая / Munkadzseki / Blusa de lucru / Pracovní blůza / Pracovná bunda / Delovna jakna / Darbiniai marškiniai / Darba kreklis / Töjakk / Работна блуза / Radna bluza / Radna bluza / Μηλούτζα εργασίας / Sudadera de trabajo / Giacca da lavoro / Blusão de trabalho / Veste de travail

NEO
TOOLS



Ref.	Size	☒	EAN
81-217-XS	XS/46	0/20	5907558446869
81-217-S	S/48	0/20	5907558446876
81-217-M	M/50	0/20	5907558446883
81-217-L	L/52	0/20	5907558446890
81-217-XL	XL/54	0/20	5907558446906
81-217-XXL	XXL/56	0/20	5907558446913
81-217-XXXL	XXXL/58	0/20	5907558446920

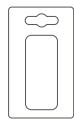

Możliwość połączenia ze spodniami roboczymi 81-227 w kombinезон (elastyczny pas z zamkiem w środku)
Can be matched with jacket 81-227 into a jumpsuit (elastic waistband with a zipper inside)
Можно комбинировать с брюками рабочими 81-227 в комбинезон (пояс на резинке на молнии внутри)

NEO
TOOLS

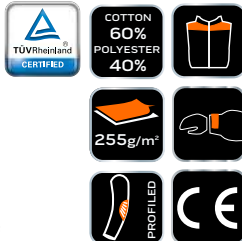

Ref.	Size	☒	EAN
81-211-S	S/48	0/20	5907558434842
81-211-M	M/50	0/20	5907558434859
81-211-L	L/52	0/20	5907558434866
81-211-XL	XL/54	0/20	5907558434873
81-211-XXL	XXL/56	0/20	5907558434880
81-211-XXXL	XXXL/58	0/20	5907558441963

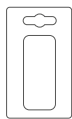

NEO
TOOLS



Ref.	Size	☒	EAN
81-213-S	S/48	0/20	5907558443035
81-213-M	M/50	0/20	5907558443042
81-213-L	L/52	0/20	5907558443059
81-213-XL	XL/54	0/20	5907558443066
81-213-XXL	XXL/56	0/20	5907558443073
81-213-XXXL	XXXL/58	0/20	5907558443080

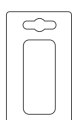

NEO
TOOLS



Ref.	Size	☒	EAN
81-215-S	S/48	0/20	5907558435092
81-215-M	M/50	0/20	5907558435108
81-215-L	L/52	0/20	5907558435115
81-215-XL	XL/54	0/20	5907558435122
81-215-XXL	XXL/56	0/20	5907558435139

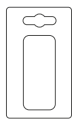

Bluza robocza

Working top / Arbeitsshirt / Блуза рабочая / Куртка рабочая / Munkadzseki / Blusa de lucru / Pracovní blůza / Pracovná bunda / Delovna jakna / Darbiniai marškiniai / Darba kreklis / Tööjakk / Рабочна блуза / Radna bluza / Radna bluza / Μπλούζα εργαίας / Sudadera de trabajo / Giacca da lavoro / Blusaõ de trabalho / Veste de travail

NEO
TOOLS



NEO
TOOLS



Ref.	Size	☒	EAN
81-218-S	S/48	0/20	5907558451597
81-218-M	M/50	0/20	5907558451603
81-218-L	L/52	0/20	5907558451610
81-218-XL	XL/54	0/20	5907558451627
81-218-XXL	XXL/56	0/20	5907558451634
81-218-XXXL	XXXL/58	0/20	5907558451641

Ref.	Size	☒	EAN
81-110-S	S/48	0/10	5902062018120
81-110-M	M/50	0/10	5902062018137
81-110-L	L/52	0/10	5902062018144
81-110-LD	LD/54	0/10	5902062018151
81-110-XL	XL/56	0/10	5902062018168
81-110-XXL	XXL/58	0/10	5902062018175

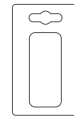
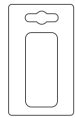

NEO
TOOLS



NEO
TOOLS



Ref.	Size	☒	EAN
81-210-S	S/48	0/10	5907558419023
81-210-M	M/50	0/10	5907558419030
81-210-L	L/52	0/10	5907558419047
81-210-LD	L/54	0/10	5907558419054
81-210-XL	XL/56	0/10	5907558419061
81-210-XXL	XXL/58	0/10	5907558419078

Ref.	Size	☒	EAN
81-410-S	S/48	0/10	5907558415384
81-410-M	M/50	0/10	5907558415391
81-410-L	L/52	0/10	5907558415407
81-410-LD	L/54	0/10	5907558415414
81-410-XL	XL/56	0/10	5907558415421
81-410-XXL	XXL/58	0/10	5907558415438

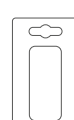
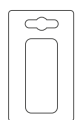

NEO
TOOLS



NEO
TOOLS



Ref.	Size	☒	EAN
81-310-S	S/48	0/10	5907558419375
81-310-M	M/50	0/10	5907558419382
81-310-L	L/52	0/10	5907558419399
81-310-LD	L/54	0/10	5907558419405
81-310-XL	XL/56	0/10	5907558419412
81-310-XXL	XXL/58	0/10	5907558419429

Ref.	Size	☒	EAN
81-311-S	S/48	0/20	5907558452990
81-311-M	M/50	0/20	5907558453003
81-311-L	L/52	0/20	5907558453010
81-311-XL	L/54	0/20	5907558453027
81-311-XXL	XL/56	0/20	5907558453034
81-311-XXXL	XXL/58	0/20	5907558453041

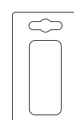
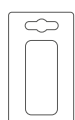

Bluza polarowa

Polar fleece jacket / Arbeitskittel aus Polarfleece / Блуза из флиса / Мајстерка / Polár munkadzseki / Bluza polar / Fleeceová mikina / Flísová bunda / Jopič iz flisa / Džemperis iš polarinio fliso audinio / Flíša jaka / Flíis / Блузна от фротте / Bluza od polara / Jakna / Μπλούζα φλις / Chaqueta de polar / Giacca in pile / Camisola polar / Polo polaire / Fleece trui

NEO
TOOLS



Ref.	Size	☒	EAN
80-500-S	S/48	0/14	5907558434132
80-500-M	M/50	0/14	5907558434149
80-500-L	L/52	0/14	5907558434156
80-500-XL	XL/54	0/14	5907558434163
80-500-XXL	XXL/56	0/14	5907558434170



NEO
TOOLS

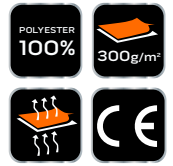

Ref.	Size	☒	EAN
80-501-S	S/48	0/14	5907558434187
80-501-M	M/50	0/14	5907558434194
80-501-L	L/52	0/14	5907558434200
80-501-XL	XL/54	0/14	5907558434217
80-501-XXL	XXL/56	0/14	5907558434224

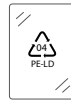

NEO
TOOLS



Ref.	Size	☒	EAN
81-506-S	S/48	0/13	5907558441482
81-506-M	M/50	0/13	5907558441499
81-506-L	L/52	0/13	5907558441505
81-506-XL	XL/54	0/13	5907558441512
81-506-XXL	XXL/56	0/13	5907558441529
81-506-XXXL	XXXL/58	0/13	5907558441536



NEO
TOOLS



Ref.	Size	☒	EAN
81-505-S	S/48	0/15	5907558434699
81-505-M	M/50	0/15	5907558434705
81-505-L	L/52	0/15	5907558434712
81-505-XL	XL/54	0/15	5907558434729
81-505-XXL	XXL/56	0/15	5907558434736

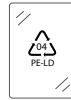

NEO
TOOLS



Ref.	Size	☒	EAN
81-500-S	S/48	0/20	5907558419498
81-500-M	M/50	0/20	5907558419504
81-500-L	L/52	0/20	5907558419511
81-500-XL	XL/56	0/20	5907558419528
81-500-XXL	XXL/58	0/20	5907558419535



NEO
TOOLS



Ref.	Size	☒	EAN
81-501-S	S/48	0/20	5907558429237
81-501-M	M/50	0/20	5907558429244
81-501-L	L/52	0/20	5907558429251
81-501-XL	XL/56	0/20	5907558429268
81-501-XXL	XXL/58	0/20	5907558429275

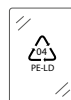

Bluza dziana

Knitted sweatshirt / Strickbluse / Тенная блуза / Блуза трикотажна / Kötött blúz / Bluz tricotaj / Pletená mikina / Pletená bunda / Pletena bluza / Džemperis / Trikotāžas sporta džemperis / Trikotāžist dressiplusus / Телефон за работа при тежки условия / Bluza od pletenine / Pletena bluza / Μηλούζα πλεκτή στημιονιά / Sudadera de punto / Felpa in tessuto / Blusão em malha / Blouzen tricot / Katoenen trui

NEO
TOOLS



Ref.	Size	☒	EAN
80-555-S	S/48	0/10	5907558433500
80-555-M	M/50	0/10	5907558433517
80-555-L	L/52	0/10	5907558433524
80-555-XL	XL/54	0/10	5907558433531
80-555-XXL	XXL/56	0/10	5907558433548



NEO
TOOLS



Ref.	Size	☒	EAN
81-556-S	S/48	0/10	5907558428124
81-556-M	M/50	0/10	5907558428131
81-556-L	L/52	0/10	5907558428148
81-556-XL	XL/56	0/10	5907558428155
81-556-XXL	XXL/58	0/10	5907558428162
81-556-XXXL	XXXL/60	0/10	5907558428179



NEO
TOOLS



Ref.	Size	☒	EAN
81-555-S	S/48	0/10	5907558428063
81-555-M	M/50	0/10	5907558428070
81-555-L	L/52	0/10	5907558428087
81-555-XL	XL/56	0/10	5907558428094
81-555-XXL	XXL/58	0/10	5907558428100
81-555-XXXL	XXL/60	0/10	5907558428117



Bluza robocza

Working top / Arbeitsshirt / Рабочая толстовка / Куптка робоча / Munkadzseki / Bluza de lucru / Pracovní blůza / Pracovní bunda / Delovna jakna / Darbiniai marškiniai / Darba kreklis / Tøjakk / Рабочая блуза / Radna bluza / Radna bluza / Μηλούζα εργαίας / Sudadera de trabajo / Giacca da lavoro / Blusão de trabalho / Veste de travail

NEO
TOOLS



Ref.	Size	☒	EAN
81-511-S	S/48	0/20	5907558441420
81-511-M	M/50	0/20	5907558441437
81-511-L	L/52	0/20	5907558441444
81-511-XL	XL/54	0/20	5907558441451
81-511-XXL	XXL/56	0/20	5907558441468
81-511-XXXL	XXXL/58	0/20	5907558441475

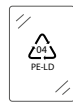

NEO
TOOLS



Ref.	Size	☒	EAN
81-512-S	S/48	0/15	5907558439687
81-512-M	M/50	0/15	5907558439694
81-512-L	L/52	0/15	5907558439700
81-512-XL	XL/54	0/15	5907558439717
81-512-XXL	XXL/56	0/15	5907558439724
81-512-XXXL	XXXL/58	0/15	5907558439731

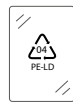

NEO
TOOLS

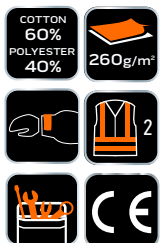

Ref.	Size	☒	EAN
81-742-S	S/48	0/20	5902062062871
81-742-M	M/50	0/20	5902062062888
81-742-L	L/52	0/20	5902062062895
81-742-XL	XL/56	0/20	5902062062901
81-742-XXL	XXL/58	0/20	5902062062918
81-742-XXXL	XXXL/60	0/20	5902062062925

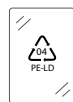

Bluza polarowa ostrzegawcza

Fleece jacket / Fleece-Pullover / Блуза из флиса / Маїстерка / Láthatósági polár / Bluza polar / Fleeceová mikina / Flísová bunda / Jopič iz flisa / Džemperis iš polarinio fliso audinio / Flíša jaka / Flísi / Блузка от флоры / Bluza od polara / Jakna / Μπλουζα φλις / Chaqueta de polar / Giacca da lavoro alta visibilità in pile / Camisola polar / Polo polaire / Fleece trui

NEO
TOOLS



NEO
TOOLS



Ref.	Size	☒	EAN
81-740-S	S/48	0/20	5907558431452
81-740-M	M/50	0/20	5907558431469
81-740-L	L/52	0/20	5907558431476
81-740-XL	XL/56	0/20	5907558431483
81-740-XXL	XXL/58	0/20	5907558431490

Ref.	Size	☒	EAN
81-741-S	S/48	0/20	5907558431506
81-741-M	M/50	0/20	5907558431513
81-741-L	L/52	0/20	5907558431520
81-741-XL	XL/56	0/20	5907558431537
81-741-XXL	XXL/58	0/20	5907558431544

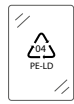

NEO
TOOLS



NEO
TOOLS



Ref.	Size	☒	EAN
81-745-S	S/48	0/10	5907558429282
81-745-M	M/50	0/10	5907558429299
81-745-L	L/52	0/10	5907558429305
81-745-XL	XL/56	0/10	5907558429312
81-745-XXL	XXL/58	0/10	5907558429329

Ref.	Size	☒	EAN
81-746-S	S/48	0/10	5907558429336
81-746-M	M/50	0/10	5907558429343
81-746-L	L/52	0/10	5907558429350
81-746-XL	XL/56	0/10	5907558429367
81-746-XXL	XXL/58	0/10	5907558429374

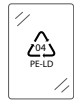

Softshell ostrzegawczy

Work jacket / Arbeitsjacke / Куртка рабочая / Куртка робоча / Láthatósági munkadzseki / Jacheta de lucru / Pracovní bunda / Pracovní bunda / Delovni jopič / Darbinė striukė / Darba jaka / Тööjope / Работно яке / Radna jakna / Radnička jakna / Μπουφάν εργασίας / Chaqueta de trabajo / Giacca da lavoro alta visibilità in softshell / Blusão de trabalho / Veste de travail

NEO
TOOLS



NEO
TOOLS

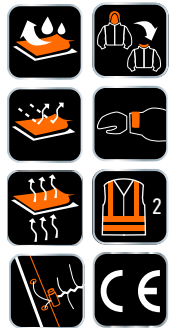

Ref.	Size	☒	EAN
81-700-S	S/48	0/10	5907558428339
81-700-M	M/50	0/10	5907558428346
81-700-L	L/52	0/10	5907558428353
81-700-XL	XL/56	0/10	5907558428360
81-700-XXL	XXL/58	0/10	5907558431254
81-700-XXXL	XXXL/60	0/10	5907558431261

Ref.	Size	☒	EAN
81-701-S	S/48	0/10	5907558428858
81-701-M	M/50	0/10	5907558428865
81-701-L	L/52	0/10	5907558428872
81-701-XL	XL/56	0/10	5907558428889
81-701-XXL	XXL/58	0/10	5907558428896
81-701-XXXL	XXL/60	0/10	5907558428902

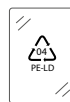
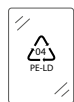

Kurtka softshell

Waterproof, windproof jacket, softshell / Wind- und wasserdichte Softshelljacke / Куртка водо- и ветронепроницаемая, softshell / Вирівка з водовідштовхувальної тканини «softshell» / Softshell munkadzseki / Djaka impermeabila, antivânt, softshell / Vodoodolná, větruvzdorná, softshellová bunda / Vodoodolná, vetruodolná, softshellová bunda / Jakna, odporna na vodu, veter, softshell / Vėjui ir vandeniui atspari striukė („softshell“) / Udensnecaurlaidīga vējjaka, softshell / Softshell vee- ja tuulekindel jope / Блуза от непоп / Vodooporna, vjetrooporna jakna softshell / Jakna otporna na vodu, vetar, sa mekim jezgrom / Αδιάβροχο μπλουζάκι για προστασία από τον αέρα / Chaqueta impermeable, antiviento, softshell / Giacca antivento, anti pioggia, softshell / Casaca corta vento impermeável softshell / Blouse imperméable pare-brise softshell

NEO
TOOLS

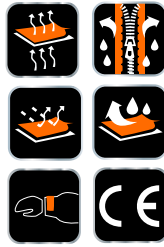

Ref.	Size	☒	EAN
80-550-S	S/48	0/10	5907558433555
80-550-M	M/50	0/10	5907558433562
80-550-L	L/52	0/10	5907558433579
80-550-XL	XL/54	0/10	5907558433586
80-550-XXL	XXL/56	0/10	5907558433593



NEO
TOOLS



Ref.	Size	☒	EAN
81-559-S	S/48	0/10	5907558441840
81-559-M	M/50	0/10	5907558441857
81-559-L	L/52	0/10	5907558441864
81-559-XL	XL/54	0/10	5907558441871
81-559-XXL	XXL/56	0/10	5907558441888
81-559-XXXL	XXXL/58	0/10	5907558441895

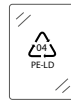

NEO
TOOLS



Ref.	Size	☒	EAN
81-553-S	S/48	0/10	5907558434644
81-553-M	M/50	0/10	5907558434651
81-553-L	L/52	0/10	5907558434668
81-553-XL	XL/54	0/10	5907558434675
81-553-XXL	XXL/56	0/10	5907558434682



NEO
TOOLS

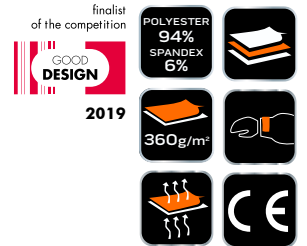

Ref.	Size	☒	EAN
81-558-S	S/48	0/10	5907558434798
81-558-M	M/50	0/10	5907558434804
81-558-L	L/52	0/10	5907558434811
81-558-XL	XL/54	0/10	5907558434828
81-558-XXL	XXL/56	0/10	5907558434835

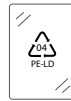

NEO
TOOLS



Ref.	Size	☒	EAN
81-551-S	S/48	0/10	5907558427943
81-551-M	M/50	0/10	5907558427950
81-551-L	L/52	0/10	5907558427967
81-551-XL	XL/56	0/10	5907558427974
81-551-XXL	XXL/58	0/10	5907558427981
81-551-XXXL	XXXL/60	0/10	5907558427998



NEO
TOOLS



Ref.	Size	☒	EAN
81-550-S	S/48	0/10	5907558419542
81-550-M	M/50	0/10	5907558419559
81-550-L	L/52	0/10	5907558419566
81-550-XL	XL/56	0/10	5907558419573
81-550-XXL	XXL/58	0/10	5907558419580



Kurtka robocza

Work jacket / Arbeitsjacke / Куртка рабочая / Куртка робоча / Munkadzseki steppelt / Jacheta de lucru / Pracovní bunda / Pracovná bunda / Delovni jopič / Darbinė striukė / Darba jaka / Тööjope / Работно яке / Radna jakna / Radnička jakna / Μπουφάν εργαίας / Chaqueta de trabajo / Giacca da lavoro imbottita / Blusão de trabalho / Veste de travail

NEO
TOOLS

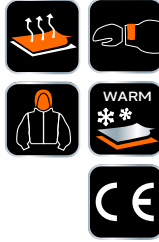

NEO
TOOLS



Ref.	Size	☒	EAN
81-554-S	S/48	0/10	5907558428780
81-554-M	M/50	0/10	5907558428797
81-554-L	L/52	0/10	5907558428803
81-554-XL	XL/56	0/10	5907558428810
81-554-XXL	XXL/58	0/10	5907558428827
81-554-XXXL	XXXL/60	0/10	5907558428834

Ref.	Size	☒	EAN
81-570-S	S/48	0/10	5907558421705
81-570-M	M/50	0/10	5907558421712
81-570-L	L/52	0/10	5907558421729
81-570-XL	XL/56	0/10	5907558421736
81-570-XXL	XXL/58	0/10	5907558421743



NEO
TOOLS



NEO
TOOLS



Ref.	Size	☒	EAN
81-571-S	S/48	0/10	5907558441666
81-571-M	M/50	0/10	5907558441673
81-571-L	L/52	0/10	5907558441680
81-571-XL	XL/54	0/10	5907558441697
81-571-XXL	XXL/56	0/10	5907558441703
81-571-XXXL	XXXL/58	0/10	5907558441710

Ref.	Size	☒	EAN
81-572-S	S/48	0/10	5907558441727
81-572-M	M/50	0/10	5907558441734
81-572-L	L/52	0/10	5907558441741
81-572-XL	XL/54	0/10	5907558441758
81-572-XXL	XXL/56	0/10	5907558441765
81-572-XXXL	XXXL/58	0/10	5907558441772

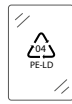

NEO
TOOLS

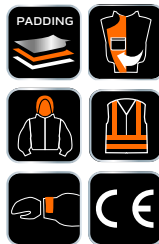

NEO
TOOLS



Ref.	Size	☒	EAN
81-573-S	S/48	0/10	5907558460254
81-573-M	M/50	0/10	5907558460261
81-573-L	L/52	0/10	5907558460278
81-573-XL	XL/54	0/10	5907558460285
81-573-XXL	XXL/56	0/10	5907558460292
81-573-XXXL	XXXL/58	0/10	5907558460308

Ref.	Size	☒	EAN
81-574-S	S/48	0/10	5907558460315
81-574-M	M/50	0/10	5907558460322
81-574-L	L/52	0/10	5907558460339
81-574-XL	XL/54	0/10	5907558460346
81-574-XXL	XXL/56	0/10	5907558460353
81-574-XXXL	XXXL/58	0/10	5907558460360

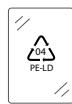
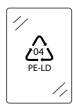

Kurtka robocza

Work jacket / Arbeitsjacke / Куртка рабочая / Куртка робоча / Munkadzseki steppelt / Jacheta de lucru / Pracovní bunda / Pracovná bunda / Delovni jopič / Darbinė striukė / Darba jaka / Тööjope / Работно яке / Radna jakna / Radnička jakna / Μπουφάν εργαίας / Chaqueta de trabajo / Giacca da lavoro imbottita / Blusão de trabalho / Veste de travail



NEO TOOLS



Ref.	Size	☒	EAN
81-575-S	S/48	0/10	5907558460377
81-575-M	M/50	0/10	5907558460384
81-575-L	L/52	0/10	5907558460391
81-575-XL	XL/54	0/10	5907558460407
81-575-XXL	XXL/56	0/10	5907558460414
81-575-XXXL	XXXL/58	0/10	5907558460421

Ref.	Size	☒	EAN
81-557-S	S/48	0/10	5907558439564
81-557-M	M/50	0/10	5907558439571
81-557-L	L/52	0/10	5907558439588
81-557-XL	XL/54	0/10	5907558439595
81-557-XXL	XXL/56	0/10	5907558439601
81-557-XXXL	XXXL/58	0/10	5907558439618

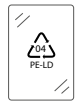

NEO TOOLS



NEO TOOLS



Ref.	Size	☒	EAN
81-720-S	S/48	0/20	5907558431339
81-720-M	M/50	0/20	5907558431346
81-720-L	L/52	0/20	5907558431353
81-720-XL	XL/56	0/20	5907558431360
81-720-XXL	XXL/58	0/20	5907558428490
81-720-XXXL	XXXL/60	0/20	5907558428506

Ref.	Size	☒	EAN
81-721-S	S/48	0/20	5907558429091
81-721-M	M/50	0/20	5907558429107
81-721-L	L/52	0/20	5907558429114
81-721-XL	XL/56	0/20	5907558429121
81-721-XXL	XXL/58	0/20	5907558429138
81-721-XXXL	XXL/60	0/20	5907558429145

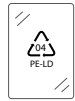

Ocieplana kurtka robocza

Work jacket / Arbeitsjacke / Куртка рабочая / Куртка робоча / Látathósági munkadzseki / Jacheta de lucru / Pracovní bunda / Pracovná bunda / Delovni jopič / Darbinė striukė / Darba jaka / Тööjope / Работно яке / Radna jakna / Radnička jakna / Μπουφάν εργαίας / Chaqueta de trabajo / Giacca da lavoro alta visibilità isolata / Blusão de trabalho / Veste de travail

NEO TOOLS

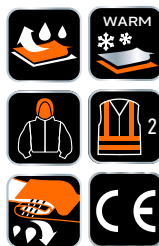

NEO TOOLS



Ref.	Size	☒	EAN
81-710-S	S/48	0/10	5907558431278
81-710-M	M/50	0/10	5907558431285
81-710-L	L/52	0/10	5907558431292
81-710-XL	XL/56	0/10	5907558431308
81-710-XXL	XXL/58	0/10	5907558431315
81-710-XXXL	XXXL/60	0/10	5907558431322

Ref.	Size	☒	EAN
81-711-S	S/48	0/10	5907558428919
81-711-M	M/50	0/10	5907558428926
81-711-L	L/52	0/10	5907558428933
81-711-XL	XL/56	0/10	5907558428940
81-711-XXL	XXL/58	0/10	5907558428957
81-711-XXXL	XXXL/60	0/10	5907558428964

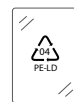
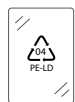

Kurtka przeciwdeszczowa

Rainproof jacket / Regenmante / Куртка влагозащитная / Куртка дощова / Esővédő kabát / Geacă de ploaie / Bunda do deště / Nepremokavá bunda / Dežna jakna / Striukė nuo lietaus / Lietus jaka / Vihmajope / Яке против дождя / Kaput za zaštitu od kiše / Jakna za zaštitu od kiše / Μπουφάν για προστασία από την υγρασία / Chaquetón impermeable / Giacca impermeabile / Casaco impermeável / Veste de pluie / Regenjas

NEO
TOOLS



Ref.	Size	☒	EAN
81-810-M	M/50	0/20	5907558444247
81-810-L	L/52	0/20	5907558444254
81-810-XL	XL/54	0/20	5907558444261
81-810-XXL	XXL/56	0/20	5907558444278
81-810-XXXL	XXXL/58	0/20	5907558444285



Komplet przeciwdeszczowy

Rainproof set / Regenset / Дождевой комплект / Комплект дощовий / Esővédő szett / Set de ploaie / Sada do deště / Nepremokavá súprava / Dežni komplet / Komplektas nuo lietaus / Lietus komplekts / Vihmariete komplekt / Комплект против дождя / Set za zaštitu od kiše / Komplet za zaštitu od kiše / Σετ βροχής / Kit de lluvia / Completo impermeabile / Kit impermeável / Ensemble de pluie / Regenset

NEO
TOOLS



Ref.	Size	☒	EAN
81-800-M	M/50	0/20	5907558444193
81-800-L	L/52	0/20	5907558444209
81-800-XL	XL/54	0/20	5907558444216
81-800-XXL	XXL/56	0/20	5907558444223
81-800-XXXL	XXXL/58	0/20	5907558444230



Kurtka wiatrówka

Windbreaker jacket / Windbreaker Jacke / Ветропна куртка / Куртка з вітром / Szélzédző kabát / Jacheta pentru parbriz / Bunda s větrovkou / Bunda vetrovku / Jakna za vetrovko / Windbreaker* striukė / Vėjaka jaka / Tuulejope jope / Сако за вятър / Jakna od vjetrovke / Jakna za vetrobran / Αντανεμικό μπουφάν / Chaqueta rompivientos / Giacca a vento / Casaco corta-vento / Veste coupe-vent

NEO
TOOLS



Ref.	Size	☒	EAN
81-561-S	S/48	0/30	5907558448207
81-561-M	M/50	0/30	5907558448214
81-561-L	L/52	0/30	5907558448221
81-561-XL	XL/54	0/30	5907558448238
81-561-XXL	XXL/56	0/30	5907558448245
81-561-XXXL	XXXL/58	0/30	5907558448252



T-shirt

T-shirt / T-Shirt / Футболка сигнальная / Футболка / Póló / T-shirt / Tričko / Tričko / Majica / Apatiniai marškinėliai - T / T-kreklis / T-särk / Тушэрт / T-shirt / Majica kratkih rukava / Κομποάνικη μπλούζα / Camiseta / Maglietta / Camisola / T-shirt / T-shirt

NEO
TOOLS



Ref.	Size	☒	EAN
81-611-S	S/48	0/50	5907558432077
81-611-M	M/50	0/50	5907558432084
81-611-L	L/52	0/50	5907558432091
81-611-XL	XL/56	0/50	5907558432107
81-611-XXL	XXL/58	0/50	5907558432114



NEO
TOOLS



Ref.	Size	☒	EAN
81-610-S	S/48	0/50	5907558432022
81-610-M	M/50	0/50	5907558432039
81-610-L	L/52	0/50	5907558432046
81-610-XL	XL/56	0/50	5907558432053
81-610-XXL	XXL/58	0/50	5907558432060



T-shirt

T-shirt / T-Shirt / Футболка сигнальная / Футболка / Póló / T-shirt / Tričko / Tričko / Majica / Apatiniai marškinėliai - T / T-kreklis / T-särk / Тушэpm / T-shirt / Majica kratkih rukava / Κορτομάνικη μπλούζα / Camiseta / Maglietta / Camisola / T-shirt / T-shirt

NEO
TOOLS

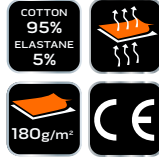

Ref.	Size	☒	EAN
80-610-S	S/36	0/50	5907558434231
80-610-M	M/38	0/50	5907558434248
80-610-L	L/40	0/50	5907558434255
80-610-XL	XL/42	0/50	5907558434262
80-610-XXL	XXL/44	0/50	5907558434279

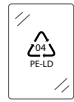

NEO
TOOLS



Ref.	Size	☒	EAN
80-611-S	S/36	0/50	5907558434286
80-611-M	M/38	0/50	5907558434293
80-611-L	L/40	0/50	5907558434309
80-611-XL	XL/42	0/50	5907558434316
80-611-XXL	XXL/44	0/50	5907558434323



NEO
TOOLS



Ref.	Size	☒	EAN
81-614-S	S/48	0/50	5907558441543
81-614-M	M/50	0/50	5907558441550
81-614-L	L/52	0/50	5907558441567
81-614-XL	XL/54	0/50	5907558441574
81-614-XXL	XXL/56	0/50	5907558441581
81-614-XXXL	XXXL/58	0/50	5907558441598

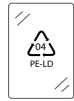

NEO
TOOLS



Ref.	Size	☒	EAN
81-602-S	S/48	0/50	5907558439748
81-602-M	M/50	0/50	5907558439755
81-602-L	L/52	0/50	5907558439762
81-602-XL	XL/54	0/50	5907558439779
81-602-XXL	XXL/56	0/50	5907558439786
81-602-XXXL	XXXL/58	0/50	5907558439793

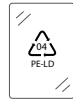

NEO
TOOLS

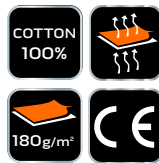

Ref.	Size	☒	EAN
81-603-S	S/48	0/50	5907558443233
81-603-M	M/50	0/50	5907558443240
81-603-L	L/52	0/50	5907558443257
81-603-XL	XL/54	0/50	5907558443264
81-603-XXL	XXL/56	0/50	5907558443271
81-603-XXXL	XXXL/58	0/50	5907558443288

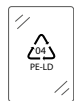

NEO
TOOLS



Ref.	Size	☒	EAN
81-612-S	S/48	0/50	5907558432121
81-612-M	M/50	0/50	5907558432138
81-612-L	L/52	0/50	5907558432145
81-612-XL	XL/54	0/50	5907558432152
81-612-XXL	XXL/56	0/50	5907558432169
81-612-XXXL	XXXL/58	0/50	5907558443288

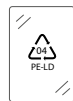

NEO
TOOLS



Ref.	Size	☒	EAN
81-613-S	S/48	0/50	5907558435245
81-613-M	M/50	0/50	5907558435252
81-613-L	L/52	0/50	5907558435269
81-613-XL	XL/54	0/50	5907558435276
81-613-XXL	XXL/56	0/50	5907558435283

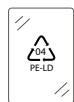

NEO
TOOLS



Ref.	Size	☒	EAN
81-615-S	S/48	0/50	5907558435344
81-615-M	M/50	0/50	5907558435351
81-615-L	L/52	0/50	5907558435368
81-615-XL	XL/54	0/50	5907558435375
81-615-XXL	XXL/56	0/50	5907558435382

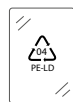

T-shirt ostrzegawczy

High visibility T-shirt / T-Shirt / Футболка сигнальная / Футболка / Láthatósági póló / T-shirt / Tričko / Tričko / Majica / Apatiniai marškinėliai - T / T-kreklis / T-särk / Тушэрт / T-shirt / Majica kratkih rukava / Κοτομάνικη μπλούζα / Camiseta / T-Shirt alta visibilità / Camisola / T-shirt / T-shirt

NEO
TOOLS

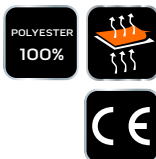

NEO
TOOLS

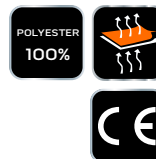

Ref.	Size	☒	EAN
81-730-S	S/48	0/50	5907558429381
81-730-M	M/50	0/50	5907558429398
81-730-L	L/52	0/50	5907558429404
81-730-XL	XL/56	0/50	5907558429411
81-730-XXL	XXL/58	0/50	5907558429428



Ref.	Size	☒	EAN
81-731-S	S/48	0/50	5907558429435
81-731-M	M/50	0/50	5907558429442
81-731-L	L/52	0/50	5907558429459
81-731-XL	XL/56	0/50	5907558429466
81-731-XXL	XXL/58	0/50	5907558429473

NEO
TOOLS

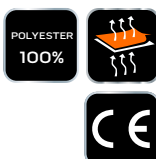

NEO
TOOLS

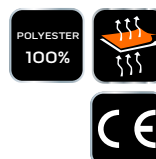

Ref.	Size	☒	EAN
81-732-S	S/48	0/50	5907558429923
81-732-M	M/50	0/50	5907558429930
81-732-L	L/52	0/50	5907558429947
81-732-XL	XL/56	0/50	5907558429954
81-732-XXL	XXL/58	0/50	5907558429961



Ref.	Size	☒	EAN
81-733-S	S/48	0/50	5907558429978
81-733-M	M/50	0/50	5907558429985
81-733-L	L/52	0/50	5907558429992
81-733-XL	XL/56	0/50	5907558430004
81-733-XXL	XXL/58	0/50	5907558430011

Koszulka polo

Polo shirt / Polo-Shirt / Футболка-поло / Сорочка-поло / Pólóing / Camasa din tesatura / Tričko polo / Polokošeľa / Majica z ovratnikom / Marškiniai „Polo“ / Polo kreklis / Polosärk / Блузка полф / Polo majica / Polo majica / Κοτομάνικη μπλούζα πόλο / Camiseta polo Polo / Camisa pólo / Chemise polo / Polo shirt

NEO
TOOLS



Ref.	Size	☒	EAN
81-606-S	S/48	0/40	5907558439809
81-606-M	M/50	0/40	5907558439816
81-606-L	L/52	0/40	5907558439823
81-606-XL	XL/54	0/40	5907558439830
81-606-XXL	XXL/56	0/40	5907558439847
81-606-XXXL	XXXL/58	0/40	5907558439854

Koszulka z długim rękawem

Longsleeve / Langarm-Shirt / Футболка с длинными рукавами / Сорочка з довгим рукавом / Hosszú ujjú ing / Cămașă cu mânecă lungă / Tričko s dlouhým rukávem / Tričko s dlhým rukávom / Srajca z dolgimi rokavi / Marškiniaiis ilgomis rankovėmis / Kreklis ar garām piedurknēm / Pikkade varrukatega särk / Блузка с дълге ръкав / Majica dugih rukava / Košulja sa dugim rukavima / Μπλουζάκι μακρομάνικο / Camisa de manga larga / Maglietta a manica lunga

NEO
TOOLS



Ref.	Size	☒	EAN
81-619-S	S/48	0/40	5907558441604
81-619-M	M/50	0/40	5907558441611
81-619-L	L/52	0/40	5907558441628
81-619-XL	XL/54	0/40	5907558441635
81-619-XXL	XXL/56	0/40	5907558441642
81-619-XXXL	XXXL/58	0/40	5907558441659

Koszulka z długim rękawem

Longsleeve / Langarm-Shirt / Футболка с длинными рукавами / Сорочка з довгим рукавом / Hosszú ujjú ing / Cămașă cu mânecă lungă / Tričko s dlouhým rukávem / Tričko s dlhým rukávom / Srajca z dolgimi rokavi / Marškiniaisu ilgomis rankovėmis / Kreklis ar garām piedurknēm / Pikkade varukatega särk / Блузка с дълъг ръкав / Majica dugih rukava / Košulja sa dugim rukavima / Μηλουζάκι μακρυμάνικο / Camisa de manga larga / Maglietta a manica lunga

NEO
TOOLS



Ref.	Size	☒	EAN
81-616-S	S/48	0/50	5907558435290
81-616-M	M/50	0/50	5907558435306
81-616-L	L/52	0/50	5907558435313
81-616-XL	XL/54	0/50	5907558435320
81-616-XXL	XXL/56	0/50	5907558435337



NEO
TOOLS



Ref.	Size	☒	EAN
81-617-S	S/48	0/50	5907558435436
81-617-M	M/50	0/50	5907558435443
81-617-L	L/52	0/50	5907558435450
81-617-XL	XL/54	0/50	5907558435467
81-617-XXL	XXL/56	0/50	5907558435474



Bezrękawnik roboczy

Work body warmer / Arbeitsweste / Жилет рабочий / Безрукавка робоча / Mellény fenyvisszaverő / Vesta de lucru / Pracovní vesta / Pracovná vesta / Delovni brezrukavnik / Darbinė liemenė / Darba jaka bez piedurknēm / Töövest / Работен елек / Radni prsluk / Radnički prsluk / Πλέκο εργασίας / Chaleco de trabajo / Gilet da lavoro doppio uso / Blusa de trabalho sem mangas / Gilet de travail

NEO
TOOLS



Ref.	Size	☒	EAN
81-534-S	S/48	0/10	5907558441789
81-534-M	M/50	0/10	5907558441796
81-534-L	L/52	0/10	5907558441802
81-534-XL	XL/54	0/10	5907558441819
81-534-XXL	XXL/56	0/10	5907558441826
81-534-XXXL	XXXL/58	0/10	5907558441833



NEO
TOOLS



Ref.	Size	☒	EAN
81-533-S	S/48	0/10	5907558434743
81-533-M	M/50	0/10	5907558434750
81-533-L	L/52	0/10	5907558434767
81-533-XL	XL/54	0/10	5907558434774
81-533-XXL	XXL/56	0/10	5907558434781



NEO
TOOLS



Ref.	Size	☒	EAN
81-520-S	S/48	0/10	5907558421750
81-520-M	M/50	0/10	5907558421767
81-520-L	L/52	0/10	5907558421774
81-520-XL	XL/56	0/10	5907558421781
81-520-XXL	XXL/58	0/10	5907558421798
81-520-XXXL	XXXL/60	0/10	5907558427776



NEO
TOOLS



Ref.	Size	☒	EAN
81-521-S	S/48	0/10	5907558427714
81-521-M	M/50	0/10	5907558427721
81-521-L	L/52	0/10	5907558427738
81-521-XL	XL/56	0/10	5907558427745
81-521-XXL	XXL/58	0/10	5907558427752
81-521-XXXL	XXXL/60	0/10	5907558427769



NEO
TOOLS



Ref.	Size	☒	EAN
81-530-S	S/48	0/20	5907558427011
81-530-M	M/50	0/20	5907558427028
81-530-L	L/52	0/20	5907558427035
81-530-XL	XL/56	0/20	5907558427042
81-530-XXL	XXL/58	0/20	5907558427059



NEO
TOOLS



Ref.	Size	☒	EAN
81-532-S	S/48	0/20	5907558427882
81-532-M	M/50	0/20	5907558427899
81-532-L	L/52	0/20	5907558427905
81-532-XL	XL/56	0/20	5907558427912
81-532-XXL	XXL/58	0/20	5907558427929
81-532-XXXL	XXXL/60	0/20	5907558427936



Kamizelka robocza

Working vest / Arbeitsweste / Жилет рабочий / Жилетка робоча / Munkamellény / Vesta de lucru / Pracovní vesta / Pracovná vesta / Delovni brezrokavnik / Darbinė liemenė / Darba veste / Töövest / Работна жилетка / Radni prsluk / Radna košulja / Γιλέκο εργασίας / Chaleco de trabajo / Gilet da lavoro / Colete de trabalho / Gilet de travail



NEO
TOOLS



Ref.	Size	☒	EAN
81-268-S	S/48	0/10	5907558451931
81-268-M	M/50	0/10	5907558451948
81-268-L	L/52	0/10	5907558451955
81-268-XL	XL/54	0/10	5907558451962
81-268-XXL	XXL/56	0/10	5907558451979
81-268-XXXL	XXXL/58	0/10	5907558451986

NEO
TOOLS



Ref.	Size	☒	EAN
81-260-S	S/48	0/10	5907558419320
81-260-M	M/50	0/10	5907558419320
81-260-L	L/52	0/10	5907558419344
81-260-XL	XL/56	0/10	5907558419351
81-260-XXL	XXL/58	0/10	5907558419368

Koszula flanelowa

Flannel shirt / Flannelhemd / Фланелевая рубашка / Сорочка фланелева / Flanel ing / Cămașă de flanelă / Flanelová košile / Flanelová košela / Flanelasta srajca / Flaneliniai marškiniai / Flanelja kreklis / Flanelisärk / Фланелена риза / Košulja od flanela / Flanelska košulja / Φανελένιο πουκάμισο / Camisa de franela / Camicia di flanelia / Camisa de flanela / Chemise en flanelle

NEO
TOOLS



Ref.	Size	☒	EAN
81-540-S	S/48	0/36	5907558432244
81-540-M	M/50	0/36	5907558432251
81-540-L	L/52	0/36	5907558432268
81-540-XL	XL/54	0/36	5907558432275
81-540-XXL	XXL/56	0/36	5907558432282



NEO
TOOLS



Ref.	Size	☒	EAN
81-541-S	S/48	0/36	5907558432299
81-541-M	M/50	0/36	5907558432305
81-541-L	L/52	0/36	5907558432312
81-541-XL	XL/54	0/36	5907558432329
81-541-XXL	XXL/56	0/36	5907558432336



Koszula robocza

Work shirt / Arbeitshemd / Рабочая рубашка / Рбоча сорочка / Munka ing / Cămașă de lucru / Pracovní košile / Pracovná košela / Delovna majica / Darbo marškiniai / Darba kreklis / Töösärk / Работна риза / Radna košulja / Radna majica / εργασία πουκάμισο / Camisa de trabajo / Camicia da lavoro / Camisa de trabajo / Chemise de travail / Werk shirt

NEO
TOOLS

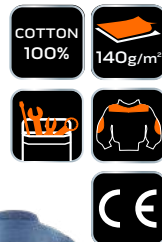

Ref.	Size	☒	EAN
81-549-S	S/48	0/30	5907558439625
81-549-M	M/50	0/30	5907558439632
81-549-L	L/52	0/30	5907558439649
81-549-XL	XL/54	0/30	5907558439656
81-549-XXL	XXL/56	0/30	5907558439663
81-549-XXXL	XXXL/58	0/30	5907558439670



Koszulka termoaktywna

Thermal long sleeve / Thermo-Funktionsunterwäsche Hemd langarm / Термоактивная блуза / Футболка з довгим рукавом термоактивна / Thermo alältözet felső / Cămașă termoactivă / Termoaktivni tričko / Termo tričko / Termo majica / Termo marškinėliai / Termoveļas kreklis / Termoaktiivne alussärk / Термоактивна блуза / Термоактивна майца / Термоактивна кошуља / Ισοθερμική μπλούζα / Camiseta termoactiva / Maglia termica / Camisola térmica / Chemise thermoactive / Thermoactivev shirt

NEO
TOOLS

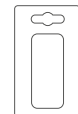

Ref.	Size	⊠	EAN
81-660-S/M	S/48 / M/50	0/60	5907558431964
81-660-L/XL	L/52 / XL/54	0/60	5907558431971
81-660-XXL/XXXL	XXL/56 / XXXL/58	0/60	5907558431988

NEO
TOOLS

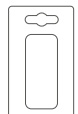

Ref.	Size	⊠	EAN
81-661-S/M	S/48 / M/50	0/50	5907558448900
81-661-L/XL	L/52 / XL/54	0/50	5907558448917
81-661-XXL/XXXL	XXL/56 / XXXL/58	0/50	5907558431971

NEO
TOOLS

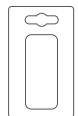

Ref.	Size	⊠	EAN
81-662-S/M	S/48 / M/50	0/60	5907558463392
81-662-L/XL	L/52 / XL/54	0/60	5907558463408
81-662-XXL/XXXL	XXL/56 / XXXL/58	0/60	5907558463415

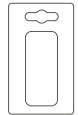

Ref.	Size	⊠	EAN
81-663-S/M	S/48 / M/50	0/60	5907558463422
81-663-L/XL	L/52 / XL/54	0/60	5907558463439
81-663-XXL/XXXL	XXL/56 / XXXL/58	0/60	5907558463446

Kalesony termoaktywne

Thermal leggings / Thermo-Funktionsunterwäsche Hose / Термоактивные кальсоны / Кальсоны термоактивни / Thermo alältözet alsó / Izmene thermoactive / Termoaktivni kalhoty (spodky) / Termo spodné nohavice / Termo spodnje hlače / Termo kelhēs / Termoveļas bikses / Termoaktiivsed pīkad aluspiiksid / Термоактивен клин / Термоактивне дуге гаће / Термоактивне pantalone / Ισοθερμικό κολάν / Mallas termoactivas / Calzamaglia termica / Calças justas térmicas / Caleçon thermoactif / Thermoactivev broek

NEO
TOOLS

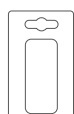

Ref.	Size	⊠	EAN
81-670-S/M	S/48 / M/50	0/60	5907558431995
81-670-L/XL	L/52 / XL/54	0/60	5907558432008
81-670-XXL/XXXL	XXL/56 / XXXL/58	0/60	5907558432015

NEO
TOOLS

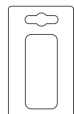

Ref.	Size	⊠	EAN
81-671-S/M	S/48 / M/50	0/50	5907558448931
81-671-L/XL	L/52 / XL/54	0/50	5907558448948
81-671-XXL/XXXL	XXL/56 / XXXL/58	0/50	5907558448955

NEO
TOOLS

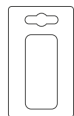

Ref.	Size	⊠	EAN
81-672-S/M	S/48 / M/50	0/60	5907558463453
81-672-L/XL	L/52 / XL/54	0/60	5907558463460
81-672-XXL/XXXL	XXL/56 / XXXL/58	0/60	5907558463477

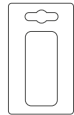
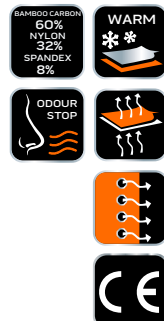

Ref.	Size	⊠	EAN
81-673-S/M	S/48 / M/50	0/60	5907558463484
81-673-L/XL	L/52 / XL/54	0/60	5907558463491
81-673-XXL/XXXL	XXL/56 / XXXL/58	0/60	5907558463507

Czapka z daszkami

Work cap / Schildmütze / Бейсболка рабочая / Бейсболка рабочая / Láthatósági sapka / Sapca cu corozor / Pracovní kšiltovka / Čiapka so šiltom, pracovná / Delovna kapa s šiltom / Kepurë su snapelium / Darba cepure ar nagu / Nokaga töömüts / Рабочая шапка с козырком / Radna kapa / Radnička kapa / Καπέλο εργασίας τύπου μπέιζμπολ / Gorra de trabajo / Cappello / Boné de trabalho / Casquette de travail à visière

NEO
TOOLS



COTTON
60%
POLYESTER
40%

255g/m²

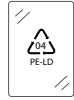

Ref.	Info	EAN
81-626	50/100	5907558442489

NEO
TOOLS

POLYESTER
100%

ONE
SIZE



Ref.	Info	Info	EAN
81-793		25/100	5907558429909
81-794		25/100	5907558429916

NEO
TOOLS



Ref.	Info	EAN
81-620	15/60	5907558407624

NEO
TOOLS



COTTON
100%

ONE
SIZE



Ref.	Info	EAN
81-625	25/100	5907558453669

Czapka

Cap / Mütze / Шапка / Шапка / Sapka / Čaciulă / Čepice / Čiapka / Kapa / Kepurë / Mütz / Шапка / Kapa / Kapa / Καπέλο τύπου τζόκεϊ / Gorra / Cappello / Gorro / Casquette / Muts

NEO
TOOLS



WOOL
50%
ACRYLIC
50%

ONE
SIZE

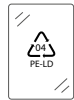

Ref.	Info	EAN
81-624	0/10	5907558450811

NEO
TOOLS



ACRYLIC
100%

320
g/m²



81-623



Ref.	Info	Info	EAN
81-622	320 g/m ²	0/200	5907558428315
81-623	320 g/m ² , fleece	0/200	5907558428322

Czapka z latarką

Cap with flashlight / Mütze mit Stirnlampe / Бейсболка с фонариком / Шапка з ліхтарем / Sapka lámpával / Čaciulă cu lanternă / Čepice s baterkou / Čiapka s baterkou / Kapa z lučkou / Kepurë su žibintuvëliu / Cepure ar lukturi / Lambiga mütz / Шапка с фенерче / Kapa sa svjetiljkom / Kapa s lampom / Καπέλο τύπου τζόκεϊ με φακό / Gorra con linterna / Cappello con torcia elettrica / Gorro con lanterna / Casquette avec torche

NEO
TOOLS

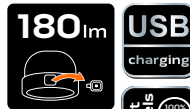

180lm
USB
charging

3 light
models
100%
75%
50%

WATER
RESISTANS
LAMP

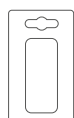

Ref.	Info	EAN
81-621	12/120	5907558428308

NEO
TOOLS



81-632



81-631



81-630



180lm
USB
charging

3 light
models
100%
75%
50%

WATER
RESISTANS
LAMP



Ref.	Info	EAN
81-630	0/100	5907558460179
81-631	0/100	5907558460186
81-632	0/100	5907558460193

Komin

Tube scarf / Schlauchschal / Шарф-труба / Трубка шарф / Cső sál / Eşarfa de tub / Trubice šátek / Trubičkový sál / Cevni šal / Vamzdžio skara / Caurules šalle / Torusall / Τρῆβεν σαν / Cijevni šal / Трубе сан / Κασκόλ σωλήνα / Bufanda de tubo / Sciarpa a tubo / Lenço de tubo / Écharpe tube

NEO
TOOLS

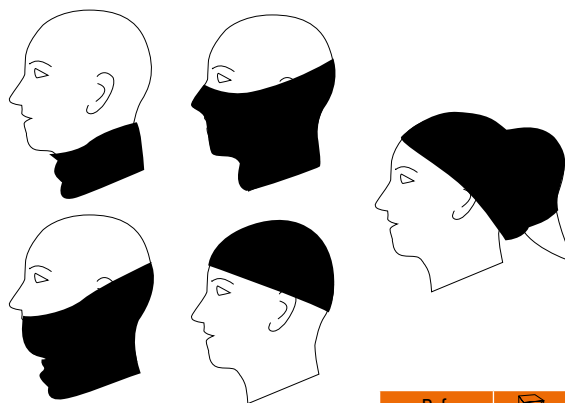

POLYESTER
92%
ELASTAN
8%

ONE
SIZE

5
in 1

WARM



Ref.		EAN
81-628	0/80	5907558450828

Pófbúty robocze

Safety shoes / Arbeitshaltschuhe / Полуботинки рабочие / Півчеревики робочі / Munkcipő / Pantofi de lucru / Pracovní obuv / Pracovné poltopánky / Nizki delovni čevlji / Darbo pusbačiai / Darba puszabaki / Töökingad / Работни обувки ниски (половинки) / Radne cipele / Poluduboke radne cipele / Ημιμποτα εργασιās / Botas de seguridad / Scarpa da lavoro / Sapatos de trabalho / Souliers de sécurité / Werkschoenen

NEO
TOOLS



Ref.	Size	Size [cm]		EAN
82-530-36	36	24	0/10	5907558437393
82-530-37	37	24.7	0/10	5907558437409
82-530-38	38	25.3	0/10	5907558437416
82-530-39	39	26	0/10	5907558437423
82-530-40	40	26.7	0/10	5907558437430
82-530-41	41	27.3	0/10	5907558437447

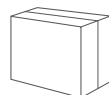

NEO
TOOLS



Ref.	Size	Size [cm]		EAN
82-510-36	36	24	0/10	5907558437515
82-510-37	37	24.7	0/10	5907558437522
82-510-38	38	25.3	0/10	5907558437539
82-510-39	39	26	0/10	5907558437546
82-510-40	40	26.7	0/10	5907558437553
82-510-41	41	27.3	0/10	5907558437560

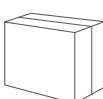

Trzewiki robocze

Safety boots / Arbeitsschuhe / Ботинки рабочие / Черевики робочі / Munkabakancs / Bocanci de lucru / Kotníková pracovní obuv / Pracovné topánky / Visoki delovni čevlji / Darbo batai / Darba zābaki / Töösaapad / Работни обувки високи (половинки) / Radne visoke cipele / Radne cipele / Μητάκια εργασιās / Botas de seguridad altas / Scarpa alta da lavoro / Botas de trabalho / Chaussures de sécurité / Hoge werkschoenen

NEO
TOOLS



Ref.	Size	Size [cm]		EAN
82-540-36	36	24	0/10	5907558437454
82-540-37	37	24.7	0/10	5907558437461
82-540-38	38	25.3	0/10	5907558437478
82-540-39	39	26	0/10	5907558437485
82-540-40	40	26.7	0/10	5907558437492
82-540-41	41	27.3	0/10	5907558437508

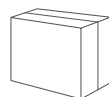

Pófbúty robocze

Safety shoes / Arbeitshaltschuhe / Полуботинки рабочие / Півчеревики робочі / Munkcipő / Pantofi de lucru / Pracovní obuv / Pracovné poltopánky / Nizki delovni čevlji / Darbo pusbačiai / Darba puszabaki / Töökingad / Работни обувки ниски (половинки) / Radne cipele / Poluduboke radne cipele / Ημιμποτα εργασιās / Botas de seguridad / Scarpa da lavoro / Sapatos de trabalho / Souliers de sécurité / Werkschoenen

NEO
TOOLS



Ref.	Size	Size [cm]		EAN
82-150-39	39	26	0/10	5907558438086
82-150-40	40	26.7	0/10	5907558438093
82-150-41	41	27.3	0/10	5907558438109
82-150-42	42	28	0/10	5907558438116
82-150-43	43	28.7	0/10	5907558438123
82-150-44	44	29.3	0/10	5907558438130
82-150-45	45	30	0/10	5907558438147
82-150-46	46	30.7	0/10	5907558438154
82-150-47	47	31.3	0/10	5907558438161

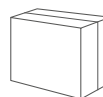

Póľbuty robocze

Safety shoes / Arbeitshalschuhe / Полуботинки рабочие / Півчеревики робочі / Мункасірб / Pantofi de lucru / Pracovní obuv / Pracovné poltopánky / Nizki delovni čevlji / Darbo pusbačiai / Darba puszabaki / Töökingad / Работни обувки ниски (половинки) / Radne cipele / Poluduboke radne cipele / Нјипјота ерџаџаџ / Botas de seguridad / Scarpa da lavoro / Sapatos de trabalho / Souliers de sécurité / Werkschoenen



NEO
TOOLS

Ref.	Size	Size [cm]	☒	EAN
82-156-36	36	24	0/10	5907558442991
82-156-37	37	24.7	0/10	5907558443004
82-156-38	38	25.3	0/10	5907558443011
82-156-39	39	26	0/10	5907558443028
82-156-40	40	26.7	0/10	5907558443301
82-156-41	41	27.3	0/10	5907558443318
82-156-42	42	28	0/10	5907558443325
82-156-43	43	28.7	0/10	5907558443332
82-156-44	44	29.3	0/10	5907558443349
82-156-45	45	30	0/10	5907558443356
82-156-46	46	30.7	0/10	5907558443363
82-156-47	47	31.3	0/10	5907558443370

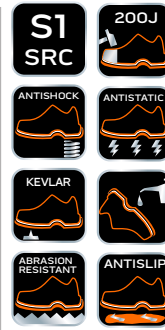
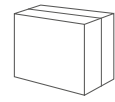

NEO
TOOLS

Ref.	Size	Size [cm]	☒	EAN
82-157-39	39	26	0/10	5907558453270
82-157-40	40	26.7	0/10	5907558453287
82-157-41	41	27.3	0/10	5907558453294
82-157-42	42	28	0/10	5907558453300
82-157-43	43	28.7	0/10	5907558453317
82-157-44	44	29.3	0/10	5907558453324
82-157-45	45	30	0/10	5907558453331
82-157-46	46	30.7	0/10	5907558453348
82-157-47	47	31.3	0/10	5907558453355

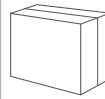

NEO
TOOLS

Ref.	Size	Size [cm]	☒	EAN
82-010	39	26	0/10	5907558412604
82-011	40	26.7	0/10	5907558414530
82-012	41	27.3	0/10	5907558414974
82-013	42	28	0/10	5907558414981
82-014	43	28.7	0/10	5907558414998
82-015	44	29.3	0/10	5907558415001
82-016	45	30	0/10	5907558415018
82-017	46	30.7	0/10	5907558415025
82-018	47	31.3	0/10	5907558421002

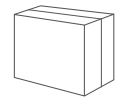

NEO
TOOLS

Ref.	Size	Size [cm]	☒	EAN
82-030	39	26	0/10	5907558415117
82-031	40	26.7	0/10	5907558415124
82-032	41	27.3	0/10	5907558415131
82-033	42	28	0/10	5907558415148
82-034	43	28.7	0/10	5907558415155
82-035	44	29.3	0/10	5907558415162
82-036	45	30	0/10	5907558415179
82-037	46	30.7	0/10	5907558415186
82-038	47	31.3	0/10	5907558421026

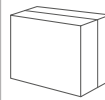

NEO
TOOLS

Ref.	Size	Size [cm]	☒	EAN
82-155-39	39	26	0/10	5907558442908
82-155-40	40	26.7	0/10	5907558442915
82-155-41	41	27.3	0/10	5907558442922
82-155-42	42	28	0/10	5907558442939
82-155-43	43	28.7	0/10	5907558442946
82-155-44	44	29.3	0/10	5907558442953
82-155-45	45	30	0/10	5907558442960
82-155-46	46	30.7	0/10	5907558442977
82-155-47	47	31.3	0/10	5907558442984

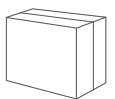

NEO
TOOLS

Ref.	Size	Size [cm]	☒	EAN
82-090	39	26	0/10	5907558426748
82-091	40	26.7	0/10	5907558426755
82-092	41	27.3	0/10	5907558426762
82-093	42	28	0/10	5907558426779
82-094	43	28.7	0/10	5907558426786
82-095	44	29.3	0/10	5907558426793
82-096	45	30	0/10	5907558426809
82-097	46	30.7	0/10	5907558426816
82-098	47	31.3	0/10	5907558426823

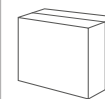

Póľbuty robocze

Safety shoes / Arbeitshaltschuhe / Полуботинки робочие / Пізчеревки робочі / Мункасірб / Pantofi de lucru / Pracovní obuv / Pracovné poltopánky / Nizki delovni čevlji / Darbo pusbačiai / Darba puszabaki / Töökingad / Работни обувки ниски (половинки) / Radne cipele / Poluduboke radne cipele / Нјітпота еруаіас / Botas de seguridad / Scarpa da lavoro / Sapatos de trabalho / Souliers de sécurité / Werkschoenen



Ref.	Size	Size [cm]	☒	EAN
82-100	39	26	0/10	5907558426830
82-101	40	26.7	0/10	5907558426847
82-102	41	27.3	0/10	5907558426854
82-103	42	28	0/10	5907558426861
82-104	43	28.7	0/10	5907558426878
82-105	44	29.3	0/10	5907558426885
82-106	45	30	0/10	5907558426892
82-107	46	30.7	0/10	5907558426908
82-108	47	31.3	0/10	5907558426915

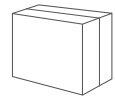

Ref.	Size	Size [cm]	☒	EAN
82-110	39	26	0/10	5907558426922
82-111	40	26.7	0/10	5907558426939
82-112	41	27.3	0/10	5907558426946
82-113	42	28	0/10	5907558426953
82-114	43	28.7	0/10	5907558426960
82-115	44	29.3	0/10	5907558426977
82-116	45	30	0/10	5907558426984
82-117	46	30.7	0/10	5907558426991
82-118	47	31.3	0/10	5907558427004

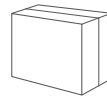

Trzewiki robocze

Safety boots / Arbeitsschuhe / Ботинки робочие / Черевинки робочі / Мункабаканс / Boscanci de lucru / Kotníková pracovní obuv / Pracovné topánky / Visoki delovni čevlji / Darbo batai / Darba zābaki / Tõõsaarad / Работни обувки високи / Radne visoke cipele / Radne cipele / Мпотаіа еруаіас / Botas de seguridad altas / Scarpa alta da lavoro / Botas de trabalho / Chaussures de sécurité / Hoge werkschoenen



Ref.	Size	Size [cm]	☒	EAN
82-151-39	39	26	0/10	5907558437997
82-151-40	40	26.7	0/10	5907558438000
82-151-41	41	27.3	0/10	5907558438017
82-151-42	42	28	0/10	5907558438024
82-151-43	43	28.7	0/10	5907558438031
82-151-44	44	29.3	0/10	5907558438048
82-151-45	45	30	0/10	5907558438055
82-151-46	46	30.7	0/10	5907558438062
82-151-47	47	31.3	0/10	5907558438079

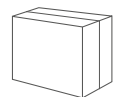

Ref.	Size	Size [cm]	☒	EAN
82-120	39	26	0/10	5907558428698
82-121	40	26.7	0/10	5907558428704
82-122	41	27.3	0/10	5907558428711
82-123	42	28	0/10	5907558428728
82-124	43	28.7	0/10	5907558428735
82-125	44	29.3	0/10	5907558428742
82-126	45	30	0/10	5907558428759
82-127	46	30.7	0/10	5907558428766
82-128	47	31.3	0/10	5907558428773

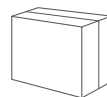

Ref.	Size	Size [cm]	☒	EAN
82-040	39	26	0/10	5907558415193
82-041	40	26.7	0/10	5907558415209
82-042	41	27.3	0/10	5907558415216
82-043	42	28	0/10	5907558415223
82-044	43	28.7	0/10	5907558415230
82-045	44	29.3	0/10	5907558415247
82-046	45	30	0/10	5907558415254
82-047	46	30.7	0/10	5907558415261
82-048	47	31.3	0/10	5907558421033

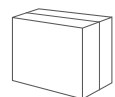

Ref.	Size	Size [cm]	☒	EAN
82-020	39	26	0/10	5907558415032
82-021	40	26.7	0/10	5907558415049
82-022	41	27.3	0/10	5907558415056
82-023	42	28	0/10	5907558415063
82-024	43	28.7	0/10	5907558415070
82-025	44	29.3	0/10	5907558415087
82-026	45	30	0/10	5907558415094
82-027	46	30.7	0/10	5907558415100
82-028	47	31.3	0/10	5907558421019

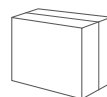

Trzewiki robocze

Safety boots / Arbeitsschuhe / Ботинки рабочие / Черевики робочі / Munkabakancs / Vocanci de lucru / Kotlíková pracovná obuv / Pracovné topánky / Visoki delovni čevlji / Darbo batai / Darba zăbaki / Töösaapad / Работни обувки високи / Radne visoke cipele / Radne cipele / Μητάκια εργαίας / Botas de seguridad altas / Scarpa alta da lavoro / Botas de trabajo / Chaussures de sécurité / Hoge werkschoenen



NEO
TOOLS



Ref.	Size	Size [cm]	☒	EAN
82-140	39	26	0/10	5907558434446
82-141	40	26.7	0/10	5907558434453
82-142	41	27.3	0/10	5907558434460
82-143	42	28	0/10	5907558434477
82-144	43	28.7	0/10	5907558434484
82-145	44	29.3	0/10	5907558434491
82-146	45	30	0/10	5907558434507
82-147	46	30.7	0/10	5907558434514
82-148	47	31.3	0/10	5907558434521

Śniegowce

Snow boots / Schneestiefel / Зимние сапоги / Снігові чоботи / Hótaposó / Vocanci de zapada / Boty do sněhu / Topánky do snehu / Snež škornji / Sniego batai / Sniega zăbaki / Lumesaapad / Обувки за снег / Čizme za snijeg / Чизме за снег / Μητάκια χιονίου / Botas de nieve / Scarponcini anti neve / Snow Botas / Bottes de neige / Sneeuwlaarzen



NEO
TOOLS



Ref.	Size	Size [cm]	☒	EAN
82-131	40	26.3	0/10	5907558428483
82-132	41	26.9	0/10	5907558428421
82-133	42	27.6	0/10	5907558428438
82-134	43	28.3	0/10	5907558428445
82-135	44	28.9	0/10	5907558428452
82-136	45	29.6	0/10	5907558428469
82-137	46	30.3	0/10	5907558428476

Sandały robocze

Working sandals / Arbeitssandale / Рабочие сандалии / Sandale de lucru / Робоци сандалии / Munkaszandál / Pracovní sandály / Pracovné sandále / Delovni sandali / Darbo sandalai / Darba sandales / Töösandaliid / Работни сандалии / Radne sandale / Σανδάλια εργαίας / Sandalias de trabajo / Sandali da lavoro / Sandálias de proteção / Sandales de travail / Werksandalen



NEO
TOOLS



Ref.	Size	Size [cm]	☒	EAN
82-070-36	36	24	0/10	5907558440782
82-070-37	37	24.7	0/10	5907558440799
82-070-38	38	25.3	0/10	5907558440805
82-070-39	39	26	0/10	5907558440812
82-070-40	40	26.7	0/10	5907558440829
82-070-41	41	27.3	0/10	5907558440836
82-070-42	42	28	0/10	5907558440843
82-070-43	43	28.7	0/10	5907558440850
82-070-44	44	29.3	0/10	5907558440867
82-070-45	45	30	0/10	5907558440874
82-070-46	46	30.7	0/10	5907558440881
82-070-47	47	31.3	0/10	5907558440898



NEO
TOOLS



Ref.	Size	Size [cm]	☒	EAN
82-080-36	36	24	0/10	5907558440904
82-080-37	37	24.7	0/10	5907558440911
82-080-38	38	25.3	0/10	5907558440928
82-080-39	39	26	0/10	5907558440935
82-080-40	40	26.7	0/10	5907558440942
82-080-41	41	27.3	0/10	5907558440959
82-080-42	42	28	0/10	5907558440966
82-080-43	43	28.7	0/10	5907558440973
82-080-44	44	29.3	0/10	5907558440980
82-080-45	45	30	0/10	5907558440997
82-080-46	46	30.7	0/10	5907558441000
82-080-47	47	31.3	0/10	5907558441017

Półbuty robocze

Safety shoes / Arbeitshalschuhe / Полуботинки рабочие / Півчеревики робочі / Munkcipő / Pantofi de lucru / Pracovní obuv / Pracovné poltopánky / Nizki delovni čevlji / Darbo pusbačiai / Darba puszăbaki / Töökingad / Работни обувки ниски (половинки) / Radne cipele / Poluduboke radne cipele / Ημιμπότα εργαίας / Botas de seguridad / Scarpa da lavoro / Sapatos de trabalho / Souliers de sécurité / Werkschoenen



NEO
TOOLS



Ref.	Size	Size [cm]	☒	EAN
82-740-39	39	26	0/10	5907558437812
82-740-40	40	26.7	0/10	5907558437829
82-740-41	41	27.3	0/10	5907558437836
82-740-42	42	28	0/10	5907558437843
82-740-43	43	28.7	0/10	5907558437850
82-740-44	44	29.3	0/10	5907558437867
82-740-45	45	30	0/10	5907558437874
82-740-46	46	30.7	0/10	5907558437881
82-740-47	47	31.3	0/10	5907558437898



NEO
TOOLS



Ref.	Size	Size [cm]	☒	EAN
82-760-36	36	24	0/10	5907558437577
82-760-37	37	24.7	0/10	5907558437584
82-760-38	38	25.3	0/10	5907558437591
82-760-39	39	26	0/10	5907558437607
82-760-40	40	26.7	0/10	5907558437614
82-760-41	41	27.3	0/10	5907558437621
82-760-42	42	28	0/10	5907558437638
82-760-43	43	28.7	0/10	5907558437645
82-760-44	44	29.3	0/10	5907558437652
82-760-45	45	30	0/10	5907558437669
82-760-46	46	30.7	0/10	5907558437676
82-760-47	47	31.3	0/10	5907558437683

Półbuty robocze

Safety shoes / Arbeitshabschuhe / Полуботинки рабочие / Півчеревики робочі / Munkacipő / Pantofi de lucru / Pracovní obuv / Pracovné poltopánky / Nizki delovni čevlji / Darbo pusbačiai / Darba puszabaki / Töökingad / Работни обувки ниски (половинки) / Radne cipele / Poluduboke radne cipele / Ημίμοτα εργασις / Botas de seguridad / Scarpa da lavoro / Sapatos de trabalho / Souliers de sécurité / Werkschoenen



NEO
TOOLS



Ref.	Size	Size [cm]	☒	EAN
82-700	39	26	0/10	5907558430073
82-701	40	26.7	0/10	5907558430080
82-702	41	27.3	0/10	5907558430097
82-703	42	28	0/10	5907558430103
82-704	43	28.7	0/10	5907558430110
82-705	44	29.3	0/10	5907558430127
82-706	45	30	0/10	5907558430134
82-707	46	30.7	0/10	5907558430141
82-708	47	31.3	0/10	5907558430158

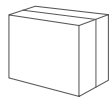

NEO
TOOLS



Ref.	Size	Size [cm]	☒	EAN
82-730	39	26	0/10	5907558430639
82-731	40	26.7	0/10	5907558430646
82-732	41	27.3	0/10	5907558430653
82-733	42	28	0/10	5907558430660
82-734	43	28.7	0/10	5907558430677
82-735	44	29.3	0/10	5907558430684
82-736	45	30	0/10	5907558430691
82-737	46	30.7	0/10	5907558430707
82-738	47	31.3	0/10	5907558429213

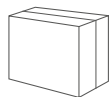

NEO
TOOLS



Ref.	Size	Size [cm]	☒	EAN
82-710	39	26	0/10	5907558430165
82-711	40	26.7	0/10	5907558430172
82-712	41	27.3	0/10	5907558430189
82-713	42	28	0/10	5907558430196
82-714	43	28.7	0/10	5907558430202
82-715	44	29.3	0/10	5907558430219
82-716	45	30	0/10	5907558430226
82-717	46	30.7	0/10	5907558430233
82-718	47	31.3	0/10	5907558430240

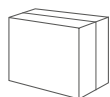

Sandaly robocze

Working sandals / Arbeitssandale / Рабочие сандалии / Sandale de lucru / Робочі стандарти / Munkaszandál / Pracovní sandály / Pracovné sandále / Delovni sandali / Darbo sandalai / Darba sandales / Töösaandlid / Работни сандали / Radne sandale / Radne sandale / Σανδάλια εργασις / Sandalias de trabajo / Sandali da lavoro / Sandalias de protección / Sandales de travail / Werksandalen



NEO
TOOLS



Ref.	Size	Size [cm]	☒	EAN
82-720	39	26	0/10	5907558430257
82-721	40	26.7	0/10	5907558430264
82-722	41	27.3	0/10	5907558430271
82-723	42	28	0/10	5907558430288
82-724	43	28.7	0/10	5907558430295
82-725	44	29.3	0/10	5907558430301
82-726	45	30	0/10	5907558430318
82-727	46	30.7	0/10	5907558430325
82-728	47	31.3	0/10	5907558430332

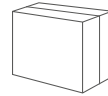

Trzewiki robocze

Safety boots / Arbeitsschuhe / Ботинки рабочие / Черевуки робочі / Munkabakancs / Bocanci de lucru / Kotníková pracovní obuv / Pracovné topánky / Visoki delovni čevlji / Darbo batai / Darba zabaki / Töösaapad / Работни обувки високи / Radne visoke cipele / Radne cipele / Μητόκια εργασις / Botas de seguridad altas / Scarpa alta da lavoro / Botas de trabalho / Chaussures de sécurité / Hoge werkschoenen



NEO
TOOLS



Ref.	Size	Size [cm]	☒	EAN
82-750-39	39	26	0/10	5907558437904
82-750-40	40	26.7	0/10	5907558437911
82-750-41	41	27.3	0/10	5907558437928
82-750-42	42	28	0/10	5907558437935
82-750-43	43	28.7	0/10	5907558437942
82-750-44	44	29.3	0/10	5907558437959
82-750-45	45	30	0/10	5907558437966
82-750-46	46	30.7	0/10	5907558437973
82-750-47	47	31.3	0/10	5907558437980

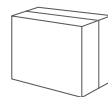

NEO
TOOLS



Ref.	Size	Size [cm]	☒	EAN
82-770-36	36	24	0/10	5907558437690
82-770-37	37	24.7	0/10	5907558437706
82-770-38	38	25.3	0/10	5907558437713
82-770-39	39	26	0/10	5907558437720
82-770-40	40	26.7	0/10	5907558437737
82-770-41	41	27.3	0/10	5907558437744
82-770-42	42	28	0/10	5907558437751
82-770-43	43	28.7	0/10	5907558437768
82-770-44	44	29.3	0/10	5907558437775
82-770-45	45	30	0/10	5907558437782
82-770-46	46	30.7	0/10	5907558437799
82-770-47	47	31.3	0/10	5907558437805

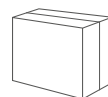

Półmaska przeciwyłowa

Dust half-mask / Staubschutzmaske / Респиратор противопылевой / Респиратор захисний протипилевої / Pormaszk / Mască mică protecție praf / Polomaska protiprašná / Respirátor protiprachový / Zaščitna maska / Puskauke nuo dulkių / Aizsargmaske / Tolmuvastane poolmask / Маска противопылевого / Zaštitna maska / Zaštitna maska / Нимаска проашноу / προστασία από ακόνη / Máscara para polvo / Semimaschera contro polvere / Máscara contra pó / Demi-masque anti-poussière / Stof half-masker

NEO
TOOLS

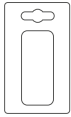

Ref.	Info	☒	EAN
97-336	x5	0/144	5907558455175
97-336-20	x20	0/54	5907558455182

NEO
TOOLS

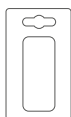

Ref.	Info	☒	EAN
97-337	x5	0/144	5907558455199
97-337-20	x20	0/54	5907558455205

NEO
TOOLS

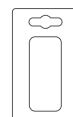

Ref.	Info	☒	EAN
97-338	x5	0/80	5907558455212
97-338-20	x20	0/18	5907558455229

NEO
TOOLS

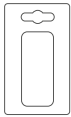

Ref.	☒	EAN
97-300	10/120	5907558407686

NEO
TOOLS

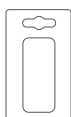
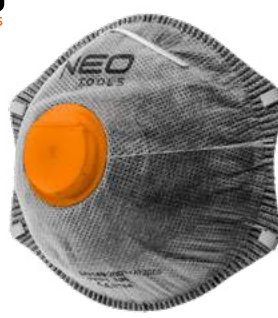

Ref.	☒	EAN
97-301	10/120	5907558407693

NEO
TOOLS

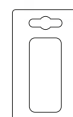

Ref.	☒	EAN
97-311	10/100	5907558407723

NEO
TOOLS

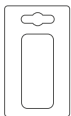

Ref.	☒	EAN
97-321	10/80	5907558421811

T TOPEX

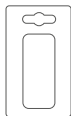

Ref.	☒	EAN
82S131	10/120	5902062821317

T TOPEX

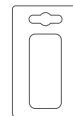

Ref.	☒	EAN
82S132	20/120	5902062821324

T TOPEX

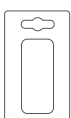

Ref.	☒	EAN
82S133	20/80	5902062200143

T TOPEX



Ref.	☒	EAN
82S137	0/100	5902062994165

T TOPEX

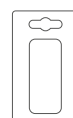

Ref.	☒	EAN
82S138	0/100	5902062994189

Okulary ochronne

Safety goggles / Schutzbrille / Очки защитные / Окуляри протиоскопичні / Védőszemüveg / Ochelari de protecție / Ochranné brýle / Ochranné okuliare / Zaščitna očala / Apsauginiai akiniai / Aizsargbrilles / Kaitseprillid / Очла предпазни / Zaštitne naočale / Zastitne naočari / Γιαυλιά προστασίας / Gafas protectoras / Occhiali di sicurezza / Óculos de proteção / Lunettes de protection / Beschermingsbril

NEO TOOLS

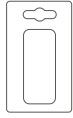

Ref. 97-508 | EAN 5907558443806

NEO TOOLS

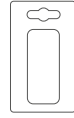

Ref. 97-502 | EAN 5907558443776

NEO TOOLS

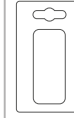

Ref. 97-503 | EAN 5907558443783

NEO TOOLS

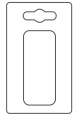

Ref. 97-504 | EAN 5907558443790

NEO TOOLS

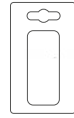

Ref. 97-500 | EAN 5907558406887

NEO TOOLS

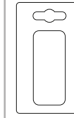

Ref. 97-501 | EAN 5907558406894

NEO TOOLS

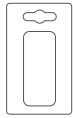

Ref. 97-510 | EAN 5907558443820



TOP TOOLS



Ref. 82S101 | EAN 5902062821010

Gogle ochronne

Protective goggles / Augenschutzbrillen / Защитные очки / Окуляри захисні / Védőszemüveg / Ochelari de protecție / Ochranné brýle / Ochranné okuliare / Zaščitna očala / Apsauginiai akiniai / Aizsargbrilles / Kaitseprillid / Защитни очла / Zaštitne gogle / Zaštitne naočare / Προστατευτικά γιαυλιά / Gafas protectoras / Occhiali protettivi / Óculos de proteção / Lunettes google de protection / Veiligheidsbril

NEO TOOLS

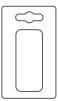

Ref. 97-512 | EAN 5907558443837

NEO TOOLS



Ref. 97-511 | EAN 5907558443769

NEO TOOLS



Ref. 97-513 | EAN 5907558443752

TOP TOOLS

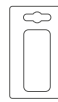

Ref. 82S102 | EAN 5902062821027

CE

Nauszniki przeciwhałasowe

Ear muff / Gehörschutz / Наушники противозвучные / Наушники захисні / Fültok / Placă de închidere ureche / Chrániče uší proti hluku / Chránič sluchu / Ščitniki za ušesa / Ausinés / Klusinātāji-austiņas / Kõrvaklapid / Антисфон / Štitnik za uši-slušalice / Štitnik za uši / Αντιθρομβικά καλύμματα αυτιών / Orejeras de protección auditiva / Cuffia di protezione / Protetores de orelhas contra barulho / Protège-oreilles anti-bruit / Lawaai gehoorbeschermers

NEO
TOOLS



SNR
27 dB
CE

Ref. 97-560
Info 0/50
EAN 5907558443721

NEO
TOOLS



SNR
25 dB
CE

Ref. 97-561
Info 0/50
EAN 5907558443738

NEO
TOOLS



SNR
24 dB
CE

Ref. 97-562
Info 0/50
EAN 5907558443745

NEO
TOOLS



SNR
30 dB
CE

Ref. 97-563
Info 0/25
EAN 5907558453263

Wkładki przeciwhałasowe

Earplugs / Ohrstöpsel / Противозвучные вкладыши / Берушка ("беруши") / Fuldugó pár / Antifoane / zátky do uší / Zátkové chrániče sluchu / Čepki za ušesa / Ausų kaištukai / Ausu aizbāžņi / Kõrvatropid / Антифону, поставяни на ушете / Сепици за уши / Сепови за уши / Πτοασπίδες / Tapones para los oídos / Tappi per le orecchie / Tampões de ovidos / Bouchons d'oreille / Oordopjes

NEO
TOOLS



x10 EN352 CE

Ref. 97-550
Size 9/11
Info 33dB
Info 25/500
EAN 5907558419634

NEO
TOOLS



x10 EN352 CE

Ref. 97-555
Size 5/16
Info 29dB
Info 40/800
EAN 5907558419641

Nakolanniki ochrone

Knee protector / Knieschützer / Наколенники защитные / Щитки наколінні захисні / Térdvédő zselés / Genunchieră protectoare / Nákolenky / Chránič kolien / Ščitniki za kolena / Apsauga keliams / Celgalu aizsargi / Рілквітсе / Наколенки / Štitnik za koljena / Štitnik za kolena / Επιγονατίδες προστατευτικές / Rodilleras de protección / Ginocchiere / Proteção de joelhos / Protège-genoux / Kniebescherming

NEO
TOOLS



x2 CE

Ref. 97-536
Info 6/24
EAN 5907558407679

NEO
TOOLS



x2 CE

Ref. 97-535
Info 6/24
EAN 5907558419627

NEO
TOOLS



TPR
x2 CE

Ref. 97-537
Info 6/12
EAN 5907558453645

NEO
TOOLS



x2 CE

Ref. 97-538
Info 6/24
EAN 5907558453652

Nakolanniki ochrone

Knee protector / Knieschützer / Щитки-наколенники / Щитки наколінні захисні / Térdvédő zselés / Genuchierä protectoare / Nakolenky / Chránic kolien / Ščitniki za kolena / Apsauga keliams / Celgalu aizsargi / Pölvekaitse / Наколенки / Štitnik za koljena / Štitnik za kolena / Επιγονατίδες προστατευτικές / Rodilleras de protecció / Ginocchiere / Proteção de joelhos / Protège-genoux / Kniebescherming

TOPEX



Ref.	☒	EAN
82S160	0/20	5902062208248

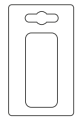

TOPEX



Ref.	☒	EAN
82S162	0/10	5902062821621

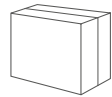

TOP TOOLS



Ref.	☒	EAN
82S161	9/36	5902062821614

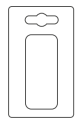

Wkładki piankowe na kolana

Knee foam pads / Knieeinlagen aus Schaumstoff / Вставки-наколенники из пеноматериала / Наколінники поліуретанові / Térdelő betét / Insertii de spuma pentru genunchi / Pěnové vložky kolien / Penové vložky na kolena / Penasti ščitniki za kolena / Apsauga keliams su putų ragalvėlėmis / Putuplasta ieliktņi celgaliem / Vahtplastist põlvekaitismed / Наколенники от пiana / Pjenasti štitnik za koljeno / Jastučici od pene za kolena / Προσθαφαιρούμενες επιγονατίδες από αφρώδες υλικό / Rodilleras de espuma / Ginocchiere / Almojada de espuma para joelho / Inserts de protection en mousse pour genoux / Schuimkniebescherming

NEO TOOLS

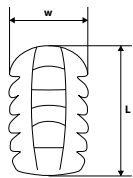

Ref.	W [mm]	L [mm]	☒	EAN
97-530	175	265	0/25	5907558419610

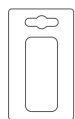

Pasek

Belt / Gürtel / Ремень / Ремінь / Öv / Curea / opasek / Opasok / Pašček / Dirželis įrankiams / Josta / Rihm / Колан / Pojas / Kaiš / Ζώνη / Cinturón / Cintura / Riem

NEO TOOLS



COTTON 100%

ONE SIZE

130 cm

Ref.	L [cm]	☒	EAN
81-900	130	0/160	5907558431148

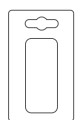

Czapka z daszkciem

Work cap / Schildmütze / Бейсболка рабочая / Бейсболка робоча / Láthatósági sapka / Sapca cu cozorac / Pracovní kšiltovka / Čiapka so šiltom, pracovná / Delovna kapa s šiltom / Kepurë su snapeliu / Darba cepure ar pagu / Nokaga töömüits / Рабочая шапка с козырком / Radna kapa / Radnička kapa / Καπέλο εργασίας τύπου μπέιζμπολ / Gorra de trabajo / Cappello / Boné de trabalho / Casquette de travail à visière

NEO TOOLS



100% COTTON



Ref.	☒	EAN
97-590	0/50	5907558415728



Kask ochronny

Safety helmet / Schutzhelm / Каска защитная / Каска захисна / Védősisak / Cască protecție / Ochranná prilba / Bezpečnostná helma / Zaščitna čelada / Apsauginis šalmas / Aizsargķivere / Kaitsekiiver / Каска / Kaciga / Κράνος προστατευτικό / Casco de protección, amarillo / Caschetto / Capacete de protecção / Casque de protection / Veiligheidshelm

TOPEX



Ref.	Info	☒	EAN
82S200		50/100	5902062994813
82S201		50/100	5902062994820

Oslona przeciwdpryskowa

Face protection shield / Splitterschutz / Щиток противосколочный / Щиток протиосколочний / Arcvédő / Ecran protecție față / Clona proti odpryskům / Ochranný štít / Ščitnik za obraz / Apsauginis skydelis veidui / Pretlauskus aizsargmaska / Kaitsevisiir / Предназен щит / Štitnik za lice / Štitnik za lice / Μάσκα κεφαλής προστασίας από θραύσματα / Máscara protectora facial / Visiera ribaltabile anti scheggia / Protecção / Protecteur anti-éclats / Bescherming tegen tegen slingerende deeltjes

TOPEX

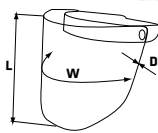

82S220

82S221

Ref.	L [mm]	W [mm]	D [mm]	☒	EAN
82S220	190	345	1	0/50	5902062994356
82S221	200	410	1	0/20	5902062994363

NEO TOOLS

NEO TOOLS

COTTON 100%

ONE SIZE

130 cm

Ref.	L [cm]	☒	EAN
81-901	130	0/150	5907558462319

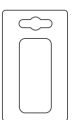

Rękawice robocze

Working gloves / Arbeitshandschuhe / Перчатки рабочие / Руквици работни / Munkakesztyű / Mänuși de lucru / Pracovní rukavice / Pracovné rukavice / Delovne rokavice / Darbo pirštinės / Darba cimdi / Töökindad / Ръкавици работни / Radne rukavice / Radne rukavice / Γάντια εργασίας / Guantes de trabajo / Guanti da lavoro / Luvas de trabalho / Gants de travail / Werkhandschoenen



Ref.	Size	☒	EAN
97-640-8	8"	10/100	5907558447811
97-640-9	9"	10/100	5907558447828
97-640-10	10"	10/100	5907558447835



Ref.	Size	☒	EAN
97-641-8	8"	10/100	5907558447842
97-641-9	9"	10/100	5907558447859
97-641-10	10"	10/100	5907558447866



Ref.	Size	☒	EAN
97-617-8	8"	10/100	5907558448023
97-617-9	9"	10/100	5907558448030
97-617-10	10"	10/100	5907558448047



Ref.	Size	☒	EAN
97-643-8	8"	10/100	5907558447903
97-643-9	9"	10/100	5907558447910
97-643-10	10"	10/100	5907558447927



Ref.	Size	☒	EAN
97-616-8	8"	10/100	5907558447996
97-616-9	9"	10/100	5907558448009
97-616-10	10"	10/100	5907558448016



Ref.	Size	☒	EAN
97-642-8	8"	10/100	5907558447873
97-642-9	9"	10/100	5907558447880
97-642-10	10"	10/100	5907558447897



Ref.	Size	☒	EAN
97-630-8	8"	10/100	5907558448115
97-630-9	9"	10/100	5907558448122
97-630-10	10"	10/100	5907558448139



Ref.	Size	☒	EAN
97-631-8	8"	10/100	5907558448146
97-631-9	9"	10/100	5907558448153
97-631-10	10"	10/100	5907558448160



Ref.	Size	☒	EAN
97-609-8	8"	10/100	5907558447934
97-609-9	9"	10/100	5907558447941
97-609-10	10"	10/100	5907558447958



Ref.	Size	☒	EAN
97-610-8	8"	10/100	5907558447965
97-610-9	9"	10/100	5907558447972
97-610-10	10"	10/100	5907558447989



Ref.	Size	☒	EAN
97-620-8	8"	10/300	5907558448054
97-620-9	9"	10/300	5907558448061
97-620-10	10"	10/300	5907558448078



Ref.	Size	☒	EAN
97-621-8	8"	10/100	5907558448085
97-621-9	9"	10/100	5907558448092
97-621-10	10"	10/100	5907558448108

Rękawice robocze

Working gloves / Arbeitshandschuhe / Перчатки рабочие / Рукавици работчи / Munkakesztyű / Mănuși de lucru / Pracovní rukavice / Pracovné rukavice / Delovne rokavice / Darbo pirštines / Darba cimdi / Töökindad / Ръкавици работни / Radne rukavice / Radne rukavice / Γάντια εργασιών / Guantes de trabajo / Guanti da lavoro / Luvas de trabalho / Gants de travail / Werkhandschoenen

NEO TOOLS

3142
KAT II
fluorescent
CE

Ref.	Size	⊠	EAN
97-611	10"	0/120	5907558421804

NEO TOOLS

KAT II
4132
CE

Ref.	Size	⊠	EAN
97-615	10"	12/120	5907558433982

NEO TOOLS

KAT II
3143
CE

Ref.	Size	⊠	EAN
97-602	10,5"	12/96	5907558406825

NEO TOOLS

KAT II
3112
CE

Ref.	Size	⊠	EAN
97-603	10"	12/120	5907558409147
97-604	8"	0/12	5907558407655

NEO TOOLS

KAT II
2121
CE

Ref.	Size	⊠	EAN
97-605	10"	0/96	5907558412901

NEO TOOLS

KAT II
4111
CE

Ref.	Size	⊠	EAN
97-606	10"	6/96	5907558412918

NEO TOOLS

KAT II
CE

Ref.	Size	⊠	EAN
97-650	10,5"	0/120	5907558448177

NEO TOOLS

KAT II
CE

Ref.	Size	⊠	EAN
97-651	10,5"	0/120	5907558448191

NEO TOOLS

KAT II
CE

Ref.	Size	⊠	EAN
97-652	10,5"	0/120	5907558448184

NEO TOOLS

KAT II
CE

Ref.	Size	⊠	EAN
97-655-8	8"	12/120	5907558455748
97-655-9	9"	12/120	5907558455755
97-655-10	10"	12/120	5907558455762

NEO TOOLS

KAT II
CE

Ref.	Size	⊠	EAN
97-656-8	8"	12/120	5907558455779
97-656-9	9"	12/120	5907558455786
97-656-10	10"	12/120	5907558455793

NEO TOOLS

KAT II
CE

Ref.	Size	⊠	EAN
97-657-8	8"	12/120	5907558455809
97-657-9	9"	12/120	5907558455816
97-657-10	10"	12/120	5907558455823

Rękawice robocze

Working gloves / Arbeitshandschuhe / Перчатки рабочие / Рукавици работни / Munkakesztyű / Mănuși de lucru / Pracovní rukavice / Pracovné rukavice / Delovne rokavice / Darbo pirštines / Darba cimdi / Töökindad / Ръкавици работни / Radne rukavice / Radne rukavice / Γάντια εργασίας / Guantes de trabajo / Guanti da lavoro / Luvas de trabalho / Gants de travail / Werkhandschoenen

NEO
TOOLS

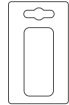

Ref.	Size	⊠	EAN
97-653	11"	12/120	5907558455830

TOPEX



Ref.	Size	⊠	EAN
83S201	10,5"	12/120	5902062200983

TOPEX



Ref.	Size	⊠	EAN
83S202	10,5"	12/240	5902062230034

TOPEX

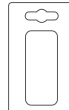

Ref.	Size	⊠	EAN
83S213	10"	12/60	5902062832139

TOP TOOLS



Ref.	Size	⊠	EAN
83S203	9"	12/600	5902062993502

Kamizelka ostrzegawcza

Warning jacket / Warnweste / Жилет светоотражающий / Жилет світлополюсний / Mellény / Jachetă încalzire / Výstržná vesta / Reflexná vesta / Opozorilni brezrokavnik / Apsauginė liemenė / Drošības veste / Hoiatusvest / Елек сизнален / Prsluk / Prsluk / Σακάκι με χρώμα προειδοποίησης / Chaleco de seguridad / Gilet riflettente / Colete de advertință / Gilet d'avertissement / Waarschuwingsvest

TOPEX

EN471



Ref.	⊠	EAN
82S170	0/120	5902062821706

Tarcza spawalnicza

Welders face shield / Schweißmaske / Щиток сварочный / Щиток зварювальний / Hegesztőpajzs / Scut p/u protejarea feței p/u sudor / Ochranný štít pro svářeče / Zváračský kukla / Zaščitna varilna maska / Suvirintojo kaukė / Metinātāja maska / Kveevitusmask / Маска за електроаржен / Маска за varioce / Маска за varioce / Μάσκα κεφαλής οξυγονοκολλητή / Mascara de soldadura / Maschera da soldatore / Disco p. Soldagem / Masque de soudeur / Lasschijf

TOPEX

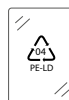
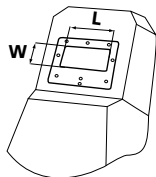

Ref.	L [mm]	W [mm]	⊠	EAN
82S210	100	50	0/20	5902062994868

TOPEX

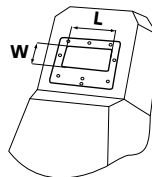

Ref.	L [mm]	W [mm]	⊠	EAN
82S211	100	80	0/20	5902062994875



BUDOWLANE
BUILDING СТРОИТЕЛЬНЫЕ



Młotek ciesielski

Carpenter's hammer / Zimmererhammer / Молоток шиферный / Молоток плотничий / Léckalapács / Ciocan de dulgher / Tesařské kladívko / Kladivo pokrývačské / Tesarsko kladivo / Plaktukas dailidei / Āmurs jumīka / Puusepahaamer / Чук кози крак / Špicasti čekić / Cekić / Σφιρί ξυλοφυρού / Martillo de carpintero / Martello da meccanico / Martelo p. Madeira / Martelet de charpentier / Timmermanshamer

NEO
TOOLS



Ref.	m [g]	H [mm]	L [mm]	W [mm]	⊠	EAN
25-101	300	124	285	21,5	6/24	5907558448269
25-102	600	155	320	27	6/24	5907558448276

NEO
TOOLS



Ref.	m [g]	H [mm]	L [mm]	W [mm]	⊠	EAN
25-131	600	170	340	29	6/24	5907558448337

TOPEX



Ref.	L [mm]	H [mm]	W [mm]	m [g]	⊠	EAN
02A855	335	175	28	600	6/24	5902062503886

TOPEX

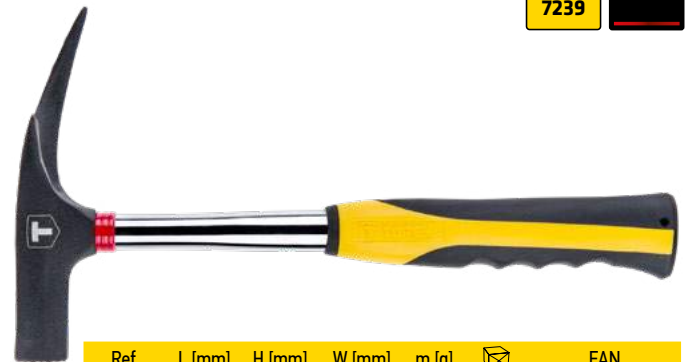

Ref.	L [mm]	H [mm]	W [mm]	m [g]	⊠	EAN
02A140	320	175	28	600	6/24	5902062031600

TOPEX



Ref.	L [mm]	H [mm]	W [mm]	m [g]	⊠	EAN
02A160	318	175	27	600	6/24	5902062030689

TOP TOOLS

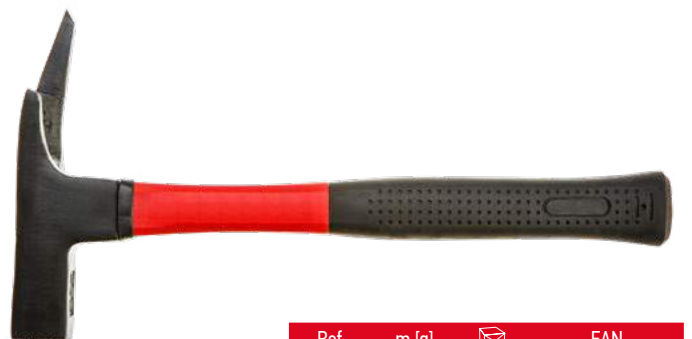

Ref.	m [g]	⊠	EAN
02A912	600	6/24	5902062012562

TOP TOOLS



Ref.	m [g]	⊠	EAN
02A180	500	6/24	5902062030139



Młotek stolarski

Claw hammer / Tischlerhammer / Молоток плотничий / Молоток столярский / Szeghúzókalapács / Ciocan tâmplar / Truhlářské kladívko / Kladivo stolárske / Tesarsko kladivo / Plaktukas staliui / Āmurs galdnieka / Sörghammer / Чук ножи крак / Stolarski čekić / Cekić / Σφυρί ξυλουργού / Martillo de carpintero / Martello ad artiglio / Martelo p. madeira / Martelet de menuisier / Tanghamer

NEO
TOOLS

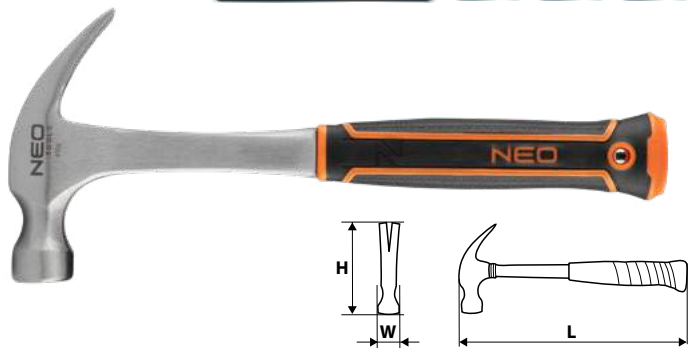

Ref.	m [g]	H [mm]	L [mm]	W [mm]	☒	EAN
25-103	450	130	320	30	6/24	5907558448283
25-104	600	135	320	30	6/24	5907558448290

NEO
TOOLS



Ref.	m [g]	H [mm]	L [mm]	W [mm]	☒	EAN
25-132	450	135	345	29	6/24	5907558448344

TOPEX



Ref.	L [mm]	H [mm]	W [mm]	m [g]	☒	EAN
02A850	335	10	29,5	450	6/24	5902062503862

TOPEX



Ref.	L [mm]	H [mm]	W [mm]	m [g]	☒	EAN
02A706	332	127	28	450	6/24	5902062030962

TOP TOOLS



Ref.	m [g]	☒	EAN
02A708	450	6/36	5902062030122

TOP TOOLS



Ref.	m [g]	☒	EAN
02A911	450	6/36	5902062012555

Młotek murarski

Masonry hammer / Maurerhammer / Молоток-кирочка / Молоток каменщика / Kőműves kalapács / Ciocan zidărie / Zednické kladívko / Kladivo murárske / Zidarsko kladivo / Plaktukas mūrīninkui / Āmurs mūrnieka / Mūīrīvasar / Чук / Zidarski čekić / Cekić / Σφυρί κτίστη / Piqueta de albañil / Martello da muratore / Martelo p. Alvenaria / Martelet de maçons / Metselaarshamer

NEO
TOOLS

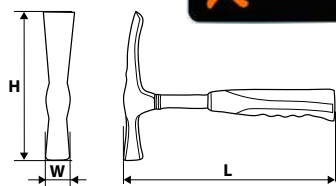

Ref.	m [g]	H [mm]	L [mm]	W [mm]	☒	EAN
25-105	600	190	317	25	6/24	5907558448306

NEO
TOOLS

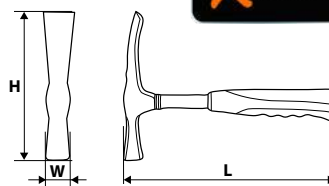

Ref.	m [g]	H [mm]	L [mm]	W [mm]	☒	EAN
25-106	600	167	314	22	6/24	5907558448313

Młotek murarski

Masonry hammer / Maurerhammer / Молоток-кирочка / Молоток каменщика / Kőműves kalapács / Ciocan zidărie / Zednické kladívko / Kladivo murárske / Zidarsko kladivo / Plaktukas mūrīnkui / Āmurs mūrnieka / Mūrīnvasar / Чук / Zidarski čekić / Cekić / Σφυρί κτίστη / Piqueta de albañil / Martello da muratore / Martelo p. Alvenaria / Martelet de maçons / Metselaarshamer

NEO
TOOLS

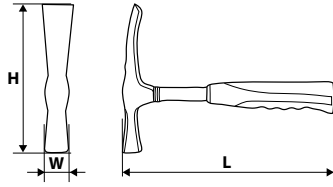

Ref.	m [g]	H [mm]	L [mm]	W [mm]	☒	EAN
25-133	600	165	343	27	6/24	5907558448351

TOPEX

DIN 5108
HARDENED



Ref.	L [mm]	H [mm]	W [mm]	m [g]	☒	EAN
02A625	288	200	26	600	6/24	5902062031617

TOPEX

DIN 5108
HARDENED



Ref.	L [mm]	H [mm]	W [mm]	m [g]	☒	EAN
02A635	280	200	26	600	6/24	5902062030696

TOPEX

DIN 5108
HARDENED



Ref.	L [mm]	H [mm]	W [mm]	m [g]	☒	EAN
02A655	283	160	24	600	6/24	5902062031037

TOPEX



Ref.	L [mm]	H [mm]	W [mm]	m [g]	☒	EAN
02A675	320	200	23	700	0/5	5902062032041

TOP TOOLS



Ref.	m [g]	☒	EAN
02A645	500	6/24	5902062030146

TOP TOOLS



Ref.	m [g]	☒	EAN
02A665	500	6/24	5902062030153

TOP TOOLS

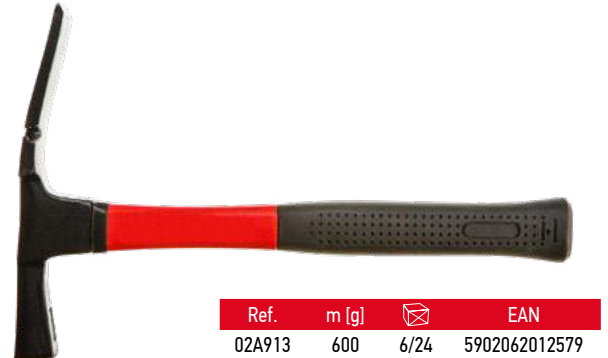

Ref.	m [g]	☒	EAN
02A913	600	6/24	5902062012579

Młotek kamieniarski

Stonning hammer / Steinmetzhammer / Молоток-кулачок / Киянка / Kalapács / Ciocan de piatră / Akmenskalđžio plaktukas / Akmens apdares āturs / Mürseravasat / Каменарски чук / Zidarski čekić / Zidarski čekić / Ξιλόφραση / Martillo de cantero / Mazzetta da muratore / Martelo p. Pedras / Martelet à taille de pierres / Steenhamer

NEO
TOOLS

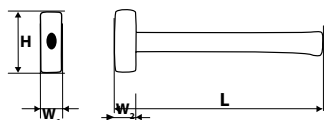

Ref.	m [g]	H [mm]	L [mm]	W [mm]	☒	EAN
25-107	1500	100	200	40	4/8	5907558448320

NEO
TOOLS



Ref.	m [g]	H [mm]	L [mm]	W [mm]	☒	EAN
25-161	4000	173	868	63	0/4	5907558448498
25-162	6000	193	877	73	0/2	5907558448504

TOP TOOLS



Ref.	m [g]	☒	EAN
02A910	1250	6/12	5902062012548

Młotek dwuobuchowy

Stoning hammer / Zweibahniger Hammer / Молоток двусторонний / Молоток двосторонний / Kalapács falbontó / Ciocan sărtuşire / Palička / Obkladačské kladivo / Kladivo macola / Plaktukas dvipusis / Vesperis / Kivihammer / Чук / Čekić / Macola / Βαριονούλα / Maza / Mazzetta da muratore / Martelo de duas faces / Martelet à tête double / Uitdeukhamer

TOP TOOLS



Ref.	m [g]	☒	EAN
02A010	1000	0/12	5902062030627
02A012	1250	0/12	5902062030320

Młotek blacharski

Rubber mallet / Klempnerhammer / Молоток жестяница / Молоток гумовий, слюсарний / Gumikalapács / Ciocan de cauciuc / Klempršské kladívko / Kladivo gumové / Kleparsko kladivo / Skardininko plaktukas / Āturs skārnieka / Kummihamer / Чук гумен / Gumeni čekić / Cekic / Ματσόλα / Maza de hojalatero / Martello di lattoniere / Martelo p. chapas / Martelet de tôlier / Plaathammer

NEO
TOOLS

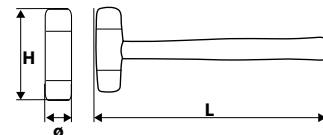
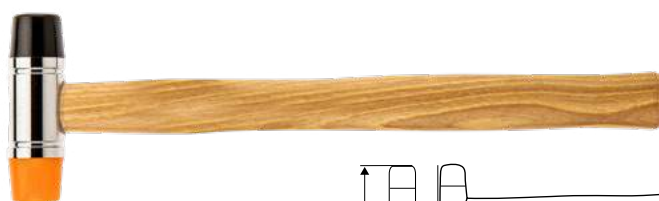

Ref.	m [g]	H [mm]	L [mm]	Ø [mm]	☒	EAN
11-620	150	75	262	22	6/48	5907558436433
11-621	250	86	280	28	6/48	5907558436440

NEO
TOOLS



Ref.	m [g]	H [mm]	L [mm]	Ø [mm]	☒	EAN
11-625	225	80	295	25	6/36	5907558436488

NEO
TOOLS



Ref.	☒	EAN
11-640	0/4	5907558436617

TOP TOOLS



Ref.	W [mm]	☒	EAN
02A330	35	0/40	5902062030368

Młotek ślusarski

Machinist hammer / Schlosserhammer / Молоток столярный / Молоток слесарный / Kalarács / Zámečnické kladívko / Kladivo zámočnické / Ključavničarsko kladivo / Plaktukas šaltkalviui / Āmurs atslēdznieka / Lukksepaahaamer / Чук / Bravarški čekić / Cekic / Σφιρί μεταλλοτεχνίτη / Martillo de cerrajero / Martello da meccanico / Martelo p. Fechos / Martelet de serrurier / Slijphamer

NEO
TOOLS



Ref.	m [g]	H [mm]	L [mm]	W [mm]	☒	EAN
25-143	300	100	295	22	6/24	5907558448368
25-144	400	110	295	25	6/24	5907558448375
25-145	500	115	325	27	6/24	5907558448382
25-146	800	130	355	32	6/12	5907558448399
25-147	1000	135	355	35	6/12	5907558448405
25-148	1500	140	410	42	4/8	5907558448412
25-149	2000	155	415	50	4/8	5907558448429

NEO
TOOLS

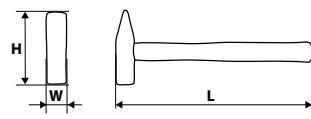

Ref.	m [g]	H [mm]	L [mm]	W [mm]	☒	EAN
25-010	100	258	82	17/12	0/10	5907558400410
25-012	200	280	95	20/12	0/10	5907558400164
25-013	300	300	105	23/12	0/10	5907558400427
25-014	400	310	110	25/12	0/10	5907558400171
25-015	500	315	118	29/6	0/10	5907558400434
25-018	800	345	130	35/6	0/10	5907558400441
25-020	1000	355	135	35/6	0/10	5907558400458
25-025	1500	378	145	42/6	0/6	5907558400465
25-030	2000	395	155	45/6	0/6	5907558400472

NEO
TOOLS



Ref.	m [g]	H [mm]	L [mm]	W [mm]	☒	EAN
25-151	3000	162	865	56	0/6	5907558448436
25-152	4000	174	867	61	0/4	5907558448443
25-153	5000	185	875	67	0/4	5907558448450
25-154	6000	195	880	71	0/2	5907558448467
25-155	8000	207	887	77,5	0/2	5907558448474
25-157	10000	220	893	83	0/2	5907558448481

NEO
TOOLS



Ref.	m [g]	H [mm]	L [mm]	W [mm]	☒	EAN
25-083	300	104	300	23	6/36	5907558400188
25-085	500	117	325	27,8	6/36	5907558400195
25-088	800	131	350	33	6/24	5907558400201
25-090	1000	137	365	36,5	6/12	5907558400218

T TOPEX



Ref.	L [mm]	H [mm]	W [mm]	m [g]	☒	EAN
02A715	318	116	29	500	6/24	5902062031631

T TOPEX



T TOPEX



Ref.	L [mm]	H [mm]	W [mm]	m [g]	☒	EAN
02A832	275	93	19,5	200	6/24	5902062504326
02A833	295	105	23	300	6/24	5902062503817
02A835	320	122	27	500	6/24	5902062503824
02A838	350	130	33,5	800	6/18	5902062503831
02A840	355	135	37,5	1000	6/18	5902062503848

Ref.	L [mm]	H [mm]	W [mm]	m	☒	EAN
02A401	257	82	13	100g	12/72	5902062031433
02A402	285	95	18	200g	12/72	5902062032324
02A403	295	105	24	300g	6/48	5902062031457
02A405	313	117	28	500g	6/36	5902062031471
02A408	340	130	34	800g	6/24	5902062031488
02A410	354	135	37	1000g	4/24	5902062031495
02A415	378	145	43	1500g	6/12	5902062031501
02A420	395	155	45	2kg	4/12	5902062031518
02A530	597	158	55	3kg	0/4	5902062030269
02A540	695	170	63	4kg	0/4	5902062030276
02A550	797	180	70	5kg	0/2	5902062030283
02A560	800	197	70	6kg	0/2	5902062030290
02A580	898	205	80	8kg	0/2	5902062030306
02A511	898	230	85	10kg	0/2	5902062030313

Młotek ślusarski

Machinist hammer / Schlosserhammer / Молоток столярный / Молоток слесарный / Kalarács / Zámečnické kladívko / Kladivo zámočnické / Ključavničarsko kladivo / Plaktukas šaltkalviui / Āmurs atslēdznieka / Lukksephaamer / Чук / Bravarški čekić / Cekić / Σιφίρι μεταλλοτεχνίτη / Martillo de cerrajero / Martello da meccanico / Martelo p. Fechos / Martelet de serrurier / Slijphamer



Ref.	m [g]	☒	EAN
02A201	100	12/120	5902062030160
02A202	200	12/96	5902062030177
02A203	300	12/60	5902062030184
02A204	400	12/60	5902062030191
02A205	500	6/36	5902062030207
02A208	800	6/24	5902062030214
02A210	1000	6/18	5902062030221
02A215	1500	0/12	5902062030238
02A220	2000	0/12	5902062030245



Ref.	m [g]	☒	EAN
02A901	100	12/96	5902062012456
02A902	200	6/60	5902062012463
02A903	300	6/36	5902062012470
02A904	400	6/36	5902062012487
02A905	500	6/24	5902062012494
02A906	800	6/18	5902062012500
02A907	1000	6/18	5902062012517

Młotek gumowy

Sörétes kalarács / Gummitammer / Киянка резиновая / Молоток резиновый / Gumikalapács / ciocan de cauciuc / Gumové kladívko / Kladivo gumové / Gumijasto kladivo / Skardininko plaktukas / Āmurs skārdnieka / Кумтиһаамер / Чук гүмен / Gumeni čekić / Cekić / Λασικένια ματσάλα / Maza de goma / Mazzuola in gomma / Martelo de borracha / Martelet en caoutchouc / Rubberen hamer

NEO
TOOLS

HICKORY WOOD

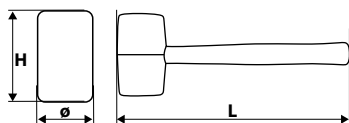

Ref.	m [g]	ø [mm]	H [mm]	L [mm]	☒	EAN
25-052	425	65	340	107	6/24	5907558409482
25-053	680	75	380	120	4/24	5907558409499
25-054	1200	90	380	130	6/12	5907558409405

NEO
TOOLS

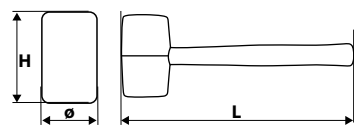
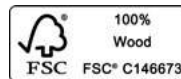

Ref.	m [g]	ø [mm]	H [mm]	L [mm]	☒	EAN
25-061	340	50	88	305	12/48	5907558440096
25-062	450	58	95	340	6/36	5907558440102
25-063	680	63	116	340	6/24	5907558440119
25-064	900	72	120	340	6/18	5907558440126

NEO
TOOLS

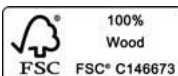

Ref.	m [g]	ø [mm]	H [mm]	L [mm]	☒	EAN
25-067	450	58	97	338	6/36	5907558440133
25-068	680	63	116	338	6/24	5907558440140

TOPEX



Ref.	L [mm]	H [mm]	ø [mm]	m [g]	☒	EAN
02A343	305	88	50	340	12/48	5902062032201
02A344	340	95	58	450	6/36	5902062032218
02A345	337	116	63	680	6/24	5902062032225
02A347	338	120	72	900	6/18	5902062032232

TOPEX



Ref.	L [mm]	H [mm]	ø [mm]	m [g]	☒	EAN
02A354	338	97	58	450	6/36	5902062032270
02A355	337	116	63	680	6/24	5902062032287

TOPEX

HARDENED



Ref.	L [mm]	H [mm]	ø [mm]	m [g]	☒	EAN
02A305	325	96	65	450	6/36	5902062031402

Młotek gumowy

Sörétes kalapács / Gummihammer / Киянка резиновая / Молоток резиновый / Gumikalapács / ciocan de cauciuc / Gumové kladívko / Kladivo gumové / Gumijasto kladivo / Skardininko plaktukas / Āmurs skārdnieka / Kummihamer / Чук зумен / Gumeni čekić / Cekic / Λαστιχένια ματσάλα / Maza de goma / Mazzuola in gomma / Martelo de borracha / Martelet en caoutchouc / Rubberen hamer



Ref.	m [g]	Ø [mm]	☒	EAN
02A310	225	40	0/50	5902062030979



Ref.	m [g]	Ø [mm]	☒	EAN
02A315	1250	90	0/12	5902062030351



Ref.	m [g]	Ø [mm]	☒	EAN
02A320	320	55	0/48	5902062030337
02A325	400	60	0/36	5902062030344

Młotek drewniany

Wooden hammer / Holzhammer / Киянка деревянная / Молоток деревянный / Fakalapács / Ciocan din lemn / Dřevěné kladívko / Kladivo drevené hranaté / Kladivo / Medinis plaktukas / Āmurs koka / Puuhaamer / Чук дървен / Drveni čekić / Cekic / Ξύλινο σφυρί / Maza de madera / Martello in legno / Martelo de madeira / Martelet en bois / Houten hamer



Ref.	L [mm]	m [g]	☒	EAN
02A050	315	500	0/30	5902062205001

Młotek z wymiennymi końcówkami

Hammer with exchangeable tips / Hammer mit auswechselbaren Oberteilen / Молоток со сменными наконечниками / Молоток зі змінними наконечниками / Cserélhető fejű kalapács / Ciocan cu capete schimbabile / Palička s výměnnými koncovkami / Kladivo s vymeniteľnými hrotmi / Kladivo z zamenljivimi konicami / Plaktukas su keičiamais antgaliais / Āmurs ar maiņas uzgaļiem / Vahetatavate otsakutega haamer / Чук със сменяеми накрайници / Čekić sa izmjenjivim nastavcima / Čekić za zamenskim delovima / Ματσάλα με εναλλάξιμα άκρα / Martillo con puntas intercambiables / Martello con punte intercambiabili / Martelo com pontas substituíveis / Marteau avec embouts interchangeables / Hemer met uitwisselbare eindstukken



Ref.	m [g]	ø [mm]	H [mm]	L [mm]	☒	EAN
11-634	250	28	114	437	6/24	5907558436570
11-636	660	45	150	430	4/8	5907558436594

Młotek bezodrzutowy

Dead blow hammer / Hammer ohne Rückschlag / Молоток безинерционный / Молоток безінерційний / Visszarúgás-mentes kalapács / Ciocan fără recul / Kladivo bez zpětného nárazu / Kladívko s tlmením odrazu / Kladivo brez povratnega udarca / Plaktukas be atatranks / Bezinerces āmurs / Kummihamer / Безоткатен чук / Нервратни čekić / Bestrajzni čekić / Ματσάλα / Martillo anti-rebote / Martello antirimbalo / Martelo / Martelet sans rebond / Vuisthamer

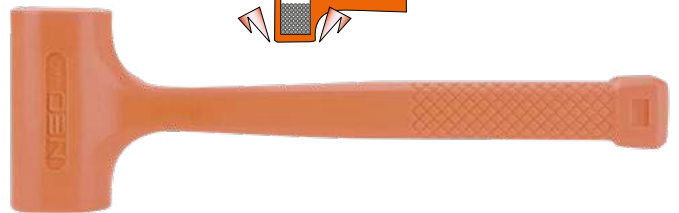
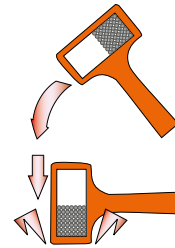

Ref.	m [g]	H [mm]	L [mm]	W [mm]	☒	EAN
25-071	840	324	100	50	6/24	5907558408935
25-072	940	338	100	53	6/18	5907558408942
25-073	1360	350	117	60	0/12	5907558408959



Ref.	L [mm]	Ø [mm]	☒	EAN
02A057	290	70	0/40	5902062205070

Młotek spawalniczy

Welding hammer / Schweißerhammer / Молоток сварочный / Молоток зварювальний / Salakverőkalapács / Ciocan lucrări sudare / Svářečské kladívko / Kladívko zváračské / Varilno kladivo / Plaktukas suvirintojui / Άμυρς μετінάτāja / Keevitushaamer / Чук за зварчуци / Čekić za varioce / Cekic / Σφυρί συγκολλητού / Martillo de soldador / Martello da saldatore / Martelo p. Soldagem / Martelet de soudure / Lashamer

TOPEX

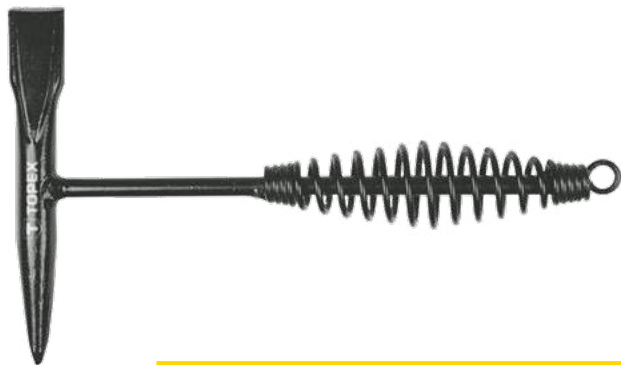

Ref.	L [mm]	m [g]	☒	EAN
02A930	280	300	6/36	5902062031662

Trzonek do pilnika

File handle / Handgriff für Pfeile / Ружоятка для напильника / Хвостовик до напилька / Reszelőnyél / Måner de pilă / Násada pilníku / Stopka pilníka / Ročaj za pilo / Rankenélé dildei / Viles spals / Viilikäepide / Држэжа на пилата / Ručka za turpiju / Držac za turpije / Χερούλι ράσας / Mango para lima / Impugnatura per lima / Cabo p. Lima / Manche de lime / Handvat voor vijl

TOPEX



Ref.	L [mm]	☒	EAN
06A615	115	0/100	5902062948830
06A635	135	0/50	5902062948847

Trzonek

Shank / Stiel / Ружоятка / Хвостовик / Kalapácsnyél / Måner / Násada / Tříň / Ročaj / Kotas / Spals / Vars / Цокъл / Držak / Drška, držalo / Χερουλαβή / Vástago / Manico per martello / Cabo / Manche / Handvat

TOPEX



Ref.	do młotka [kg]	L [mm]	☒	EAN
02A082	0,5	320	0/50	5902062031792
02A083	1,0	360	0/50	5902062031808
02A084	2,0	400	0/50	5902062031815
02A085	3,0	500	0/25	5902062031822
02A087	5,0 - 6,0	700	0/25	5902062031846
02A088	8,0	800	0/20	5902062031853
02A089	10,0	900	0/10	5902062031860

Piła płatnica

Hand saw / Fuchsschwanzsäge / Пила-ножовка / Ножовка / Kézifűrés / Ferestra manual / Pilka oscaska / Pilka ručná / Ročna žaga / Pjūklas medžiui / Ząjis kokam / Käsisaag / Τριων / Pila ručna / Testera ručna / Σεγάτα / Serrucho de carpintero / Segá a mano / Serra / Scie égoine / Handzaag

NEO TOOLS



Ref.	L [mm]	TPI	☒	EAN
41-011	400	7	12/48	5907558407099
41-016	450	7	10/40	5907558406993
41-021	500	7	10/40	5907558407006

NEO TOOLS



Ref.	L [mm]	TPI	☒	EAN
41-031	400	7	12/48	5907558407105
41-036	450	7	10/40	5907558407020
41-041	500	7	10/40	5907558407037
41-061	400	11	12/48	5907558407051
41-066	450	11	10/40	5907558407068

NEO TOOLS



EXTREME



Ref.	L [mm]	TPI	☒	EAN
41-111	400	7	6/24	5907558451573
41-116	450	7	6/24	5907558451580

NEO TOOLS



EXTREME



Ref.	L [mm]	TPI	☒	EAN
41-131	400	7	6/24	5907558451528
41-136	450	7	6/24	5907558451535
41-141	500	7	6/24	5907558451542

Piła płatnica

Hand saw / Fuchsschwanzsäge / Пила-ножовка / Ножовка / Kézifűrés / Ferestră manual / Pilka osaska / Pilka ručná / Ročna žaga / Pjūklas medžiui / Zāģis kokam / Käsisaag / Τριων / Pila ručna / Testera rucna / Σεγάρα / Serrucho de carpintero / Sega a mano / Serra / Scie égoïne / Handzaag

NEO
TOOLS



65
Mn



11TPI

EXTREME ■■■■



Ref.	L [mm]	TPI	☒	EAN
41-161	400	11	6/24	5907558451559
41-166	450	11	6/24	5907558451566



T TOPEX



Ref.	L [mm]	☒	EAN
10A441	400	10/60	5902062103390
10A446	450	10/40	5902062103406
10A451	500	10/40	5902062103413

T TOPEX

Hardened

Ergo
design

7TPI



Ref.	L [mm]	☒	EAN
10A440	400	10/40	5902062647405
10A445	450	10/40	5902062647450
10A450	500	10/40	5902062647504
10A453	560	10/40	5902062104502

T TOPEX

HARDENED

11TPI



Ref.	L [mm]	☒	EAN
10A442	400	10/60	5902062104472
10A447	450	10/40	5902062104489
10A452	500	10/40	5902062104496

TOP TOOLS

TPI
9



Ref.	L [mm]	☒	EAN
10A504	400	0/50	5902062100856
10A505	450	0/50	5902062100863
10A506	500	0/50	5902062100870

TOP TOOLS

TPI
7



Ref.	L [mm]	☒	EAN
10A540	400	10/50	5902062100887
10A545	450	10/40	5902062100894
10A550	500	10/40	5902062100900

TOP TOOLS

TPI
6



Ref.	L [mm]	☒	EAN
10A640	400	0/50	5902062101273
10A645	450	0/50	5902062101280
10A650	500	0/50	5902062101297

Piła kątowa

Mitre saw / Winkelsäge / Угловой / Стусло / Gérvágó állványos / Ferestrău tăiere sub unghi / Úhlová pila / Píłka uhlová / Kotna žaga / Pjūklas kampams / Leņķa zāģis / Saag / Машинка за перази / Pila za sjećenje pod kutom / Testera za secenje pod uglom / Φαλσποπίοιο / Sierra angular / Sega angolare di precisione / Serra de canto / Scie d'angle / Verstekzaag

NEO
TOOLS

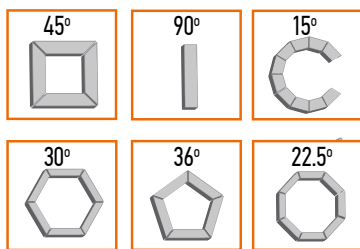

Ref.	L [mm]	☒	EAN
44-600	600	0/4	5907558408621

TOPEX



Ref.	L [mm]	☒	EAN
10A055	550	0/1	5902062100320

TOP TOOLS



Ref.	L [mm]	☒	EAN
10A035	550	0/4	5902062100795

Piła do metalu

Hacksaw / Metallsäge / Ножовка по металлу / Ножовка по металлу / Fémfűrés / Ferestrău pentru metal / Pila na kov / Píłka na kov / Žaga za kovino / Metalo pjūklas / Zāģis metālam / Metallsaag / Τριων за метал / Pila za metal / Testera za metal / Πριόνι μετάλλου / Sierra para metal / Lama per sega ad arco / Serra para metal / Scie à métal / Zaag voor metaal

NEO
TOOLS



Ref.	L [mm]	☒	EAN
43-300	300	6/36	5907558401387

NEO
TOOLS



Ref.	L [mm]	☒	EAN
43-301	300	5/20	5907558447149

NEO
TOOLS



Ref.	L [mm]	☒	EAN
43-302	300	1/24	5907558447156

NEO
TOOLS



Ref.	L [mm]	☒	EAN
43-310	150	10/60	5907558447163

Piła do metalu

Hacksaw / Metallsäge / Ножовка по металлу / Ножовка по металлу / Fémfűrés / Ferőstráru pentru metal / Pila na kov / Pílka na kov / Žaga za kovino / Metalo pjūklas / Zāģis metālam / Metallisaag / Τριων за метал / Pila za metal / Testera za metal / Πριόνι μετάλλου / Sierra para metal / Lama per sega ad arco / Serra para metal / Scie à métal / Zaag voor metaal

TOPEX



Ref.	L [mm]	⊠	EAN
10A115	150	6/72	5902062631657

TOPEX



150 [mm]



Ref.	L [mm]	⊠	EAN
10A150	150	12/72	5902062032560

TOPEX



Ref.	L [mm]	⊠	EAN
10A130	300	6/24	5902062102744

TOPEX



Ref.	L [mm]	⊠	EAN
10A135	300	6/36	5902062100771

TOPEX



Ref.	L [mm]	⊠	EAN
10A145	300	6/36	5902062103277

TOPEX



Ref.	L [mm]	⊠	EAN
10A225	250-300	12/48	5902062100153

TOPEX



300 [mm]

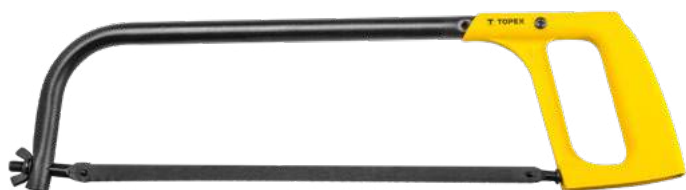

150 [mm]



Ref.	⊠	EAN
10A160	6/24	5902062032508

TOP TOOLS



Ref.	L [mm]	⊠	EAN
10A230	300	12/48	5902062100146

TOP TOOLS



Ref.	L [mm]	⊠	EAN
10A235	300	12/48	5902062100139

Piła grzbietnica

Back saw / Rückensäge / Ножовка пазовочная / Ножовка пазовочна / Illesztőfűrész / Ferestrău / Pilka hřbetovka / Pila řapovka / Lisićji rep / Pjūkļas / Zāģis leņķiem / Käsisaag / Трюн пазоамен / Pila ručna / Testera ručna / Φαλσσηπίο / Serrucho de costilla / Seg a dorso / Serra de costado / Scie à dos / Rugzaag

NEO
TOOLS



11TPI

Ref.	L [mm]	TPI	☒	EAN
41-096	350	11	12/48	5907558407082

TOPEX

HARDENED



Ref.	L [mm]	info	☒	EAN
10A703	300	9TPI	10/40	5902062101358
10A706	350	13TPI	10/40	5902062103185

TOP TOOLS

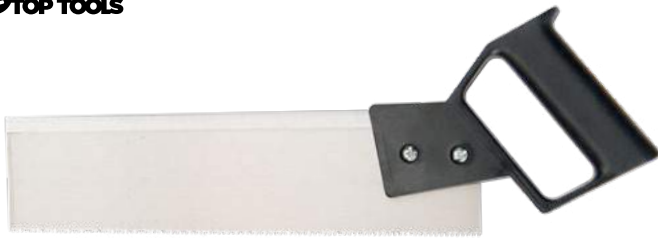

Ref.	L [mm]	☒	EAN
10A713	300	10/60	5902062100221

Piła do płyt gipsowo-kartonowych

Wallboard saw / Säge für Gipskartonplatten / Ножовка по гипсокартону / Ножовка по гипсокартону / Gipszcartonfűrész / Ferestrău pentru plăci gips carton / Pila na sádrokartón / Pilka na sadrokartón / Žaga za plošče karton-gips / Pjūkļas gipso kartono plokštnēm / Zāģis ģipškartona plāksnēm / Kipsplaadisaag / Трюн за гипсово-картонени плочи / Pila za kartonsko-gipsane ploče / Testera za gipsano-kartonske ploče / Πρίόν γυψοσανίδας / Sierra para placas de yeso laminado / Seg a per lastre in gesso / Serra p. chapas de gesso e papelão / Scie à planches de plâtre / Zaag voor gipskartonplaten

TOPEX

HARDENED



150 [mm]

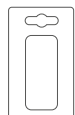

Ref.	L [mm]	☒	EAN
10A717P	150	12/36	5902062032515

NEO
TOOLS

EXTREME

hardened
STEEL

13
TPI



Ref.	L [mm]	TPI	☒	EAN
41-226	350	13	6/24	5907558455281

TOPEX

Hardened



300
[mm]

9TPI

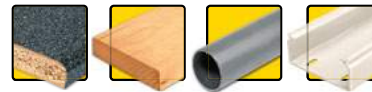

Ref.	☒	EAN
10A710	0/12	5902062032485

Piła do płyt gipsowo-kartonowych

Wallboard saw / Säge für Gipskartonplatten / Ножовка по гипсокартону / Ножовка по гипсокартону / Gipszcartonfűrész / Ferestrău pentru plăci gips carton / Pila na sádrokartón / Pilka na sadrokartón / Žaga za plošče karton-gips / Pjūkļas gipso kartono plokštnēm / Zāģis ģipškartona plāksnēm / Kipsplaadisaag / Трюн за гипсово-картонени плочи / Pila za kartonsko-gipsane ploče / Testera za gipsano-kartonske ploče / Πρίόν γυψοσανίδας / Sierra para placas de yeso laminado / Seg a per lastre in gesso / Serra p. chapas de gesso e papelão / Scie à planches de plâtre / Zaag voor gipskartonplaten

TOPEX

HARDENED



Ref.	L [mm]	☒	EAN
10A717	150	12/72	5902062103161
10A719	250	12/72	5902062032522

Nóż do wełny mineralnej

Knife for mineral wool / Messer zum Schneiden von Mineralwolle / Нож для минеральной ваты / Нож для минеральной ваты / Szegtelésanyagvágó kés / Cuiți pentru vată de sticlă / Nůž na minerální vlnu / Nůž na minerální vlnu / Rezilo za mineralno volno / Peilis mineralinei vatai / Minerálvates nazis / Minerávilvanuga / Нож за минерална вата / Nož za mineralnu vunu / Nož za mineralnu vunu / Κόπτης πετροβάμβακα / Cuchillo para lana mineral / Coltello per lana di roccia / Coltello per lana di roccia / Couteau pour laine de verre / Mes voor mineral wool

TOPEX

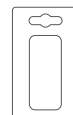

Ref.	L ₁ [mm]	L ₂ [mm]	☒	EAN
17B900	480	335	10/60	5902062141156

Piła do płyt G/K i nóż do wełny mineralnej

Wallboard saw and mineral wool knife / Gipskartonsäge mit messer und Schneiden von Mineralwolle / Ножовка для гипсокартонных плит и нож для минеральной ваты / Ножовка по гипсокартону и нож для минеральной ваты / Gipskarton és üvegyapotfűrész / Ferestrâu placă perete și cuțit pentru vată de sticlă / Pila na desky G/K a nůž na minerální vlnu / Pila na sadrokartón a nůž na minerální vlnu / Žaga za plošče iz gipsa/kartona in rezilo za mineralno volno / Pjūklas gipso kartonui ir peilis mineralinei vatai / Zāģis gipskartona un minerālvates nazis / Seinaplaadi saag ja mineraalvillanuga / Трион и нож за минерална вата / Pila za gips karton i nož za mineralnu vunu / Testera za gips karton i nož za mineralnu vunu / Πριόνι για πλακάκια G/K και κόπτης πετροβάμβακα / Serrucho para placas de yeso laminado y cuchillo para lana mineral / Segá per lastre in gesso e coltello per lana di roccia / Serra p. chapas G/K e faca para lâ mineral / Scie à planches de plâtre et couteau pour laine de verre /

TOPEX

STAINLESS
STEEL

480
[mm]

335
[mm]

x2



HARDENED

150
[mm]

Ref. EAN

10A725 0/24 5902062032546

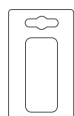

Piła otwornica

Compas saw / Stichsäge / Ножовка узкая / Сучкоріз / Lyukfűrész / Ferestrâu de traforaj / Pilka dęrowka / Pilka zlodziejka / Ozka žaga / Pjūklas angoms / Zaru zāģis / Sirkelsaag / Трион овоцарску / Pila uska / Testera uska / Πριόνι για ξύλο / Serrucho de punta / Segá a punta / Serra p. recortes / Scie à guichet / Gatenzaag

TOPEX

HARDENED

9TPI



Ref.	L [mm]	⊠	EAN
10A722	200	10/40	5902062032492
10A723	300	10/40	5902062101303

Piła do płyt gipsowo-kartonowych

Wallboard saw / Säge für Gipskartonplatten / Ножовка по гипсокартону / Ножовка по гипсокартону / Gipskartonfűrész / Ferestrâu pentru plăci gips carton / Pila na sadrokartón / Pila na sadrokartón / Žaga za plošče karton-gips / Pjūklas gipso kartono plokštēms / Zāģis gipskartona plāksnēm / Kipspladaisaag / Трион за гипсово-картоненни плочи / Pila za kartonsko-gipsane ploče / Testera za gipsano-kartonske ploče / Πριόνι γυψοσανίδας / Sierra para placas de yeso laminado / Segá per lastre in gesso / Serra p. chapas de gesso e papelão / Scie à planches de plâtre / Zaag voor gipskartonplaten

TOP TOOLS



Ref.	L [mm]	⊠	EAN
10A715	150	10/40	5902062646606

Piła otwornica

Compas saw / Stichsäge / Ножовка узкая / Сучкоріз / Lyukfűrész / Ferestrâu de traforaj / Pilka dęrowka / Pilka zlodziejka / Ozka žaga / Pjūklas angoms / Zaru zāģis / Sirkelsaag / Трион овоцарску / Pila uska / Testera uska / Πριόνι για ξύλο / Serrucho de punta / Segá a punta / Serra p. recortes / Scie à guichet / Gatenzaag

NEO TOOLS

TÜV Rheinland
CERTIFIED



Ref.	L [mm]	TPI	⊠	EAN
41-091	300	11	12/48	5907558407075

TOP TOOLS



Ref.	L [mm]	⊠	EAN
10A733	300	0/80	5902062100238

Piła do betonu komórkowego

Cellular concrete saw / Säge für Zellenbeton / Ножовка для пеноблоков / Ножовка на газобетону / Gázbetonfűrész / Ferestrâu pentru beton celular (BCA) / Pila na párobeton / Pilka na komórkový beton / Žaga za čelični beton / Pjūklas akytam betonui / Gázbetonabetonu zāģis / Saag kergbetooni saagimiseks / Трион за клетъчен бетон / Pila za betonske blokice / Testera za čelijski beton / Πριόνι ελαφρού μπετό / Sierra para bloques de hormigón celular / Segá per cemento cellulare / Serra p. Betão / Scie pour béton poreux / Zaag voor celbetonblokken

NEO TOOLS

65
Mn

HM



Ref.	L [mm]	T	⊠	EAN
41-201	800	23	6/12	5907558452952

TOPEX

HM

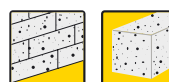

Ref.	L [mm]	⊠	EAN
10A760	600	0/12	5902062646170

TOPEX

HM

1,5mm



Ref.	L [mm]	⊠	EAN
10A761	600	6/12	5902062646187

TOPEX

Ergo
design

800
[mm]



TCT
x23
1,5
[mm]

Ref.	L [mm]	⊠	EAN
10A762	800	6/12	5902062032539

Brzeczot do metalu

Hacksaw blade / Metallsägeblatt / Полотно по металлу / Полотно ножиковое / Fémfűrész lap / Pínzá ferésztraú / Ostří na kov / Pilka na kov / Rezilo za kovino / Geležte metalui / Žága asmenis metalám / Rauasaeleht / Лист за ножовка / List Pile / List testere / Láma για σιδεροπρίοιο / Hoja de sierra para metal / Lama per metalli / Lámina p. metal / Lame de scie à métal / Lemmet voor metaal

TOPEX

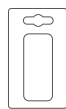

Ref.	L [mm]	W [mm]	☒	EAN
10A330	300	12,5	50/500	5902062101655

TOP TOOLS

x12

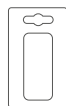

Ref.	L [mm]	W [mm]	☒	EAN
10A339	300	12,5	12/96	5902062100160

Brzeczot do metalu i drewna

Blade for metal and wood / Sägeblatt für Metall und Holz / Полотно по металлу и дереву / Полотно пильное по металлу и дереву / Fűrészlap fa-fém / Pânză de ferăstraie pentru metale și lemn / Pilový list na kov a dřevo / Čepele na kov a drevo / Žagni list za kovino in les / Pjūkliukas metalui ir medžiui / Metāla un koksnes zāģis / Saeleht metalli ja puidu saagimiseks / Ленту за метал и дървесина / Pile za metal i drvo / Sečiva za metal i drvo / Πριονόλαμα μετάλλου και ξύλου / Hoja de sierra para metal y madera / Lama per seghetto / Láminas p. metal e madeira / Lames de scie à métal et à bois / Mesblad voor metaal en hout

TOPEX

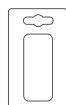

Ref.	L [mm]	W [mm]	N	☒	EAN
10A337	300	25	x1	72/720	5902062638502
10A336	300	25	x5	1/50	5902062104557
10A338	300	25	x24	0/24	5902062104564
10A337-72	300	25	x72	0/10	5902062104588

TOPEX

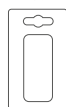

Ref.	L [mm]	☒	EAN
10A065	550	50/200	5902062100344

Uchwyt do brzeczotu

Hacksaw blade holder / Sägeblatthalterung / Держатель для полотна ножовки / Замискач до полотена ножиковоих / Fémfűrész / Fixator pínzá ferésztraú / Držák ostří / Držiak pilových plátok, kov/drevo / Vpenjalo za rezilo / Rankena asmenims / Žága asmena turētājs / Rauasaelehe hoidik / Ножовка / Držac Pile za metal-drvo / Drzac testere za metal / Láma για σιδεροπρίοιο / Mango para hoja de sierra / Lama con impugnatura in plastica / Suporte do Lámina / Monture à lame de scie / Mesbladhouder

NEO TOOLS

BI-MATERIAL HANDLE

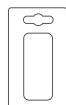

Ref.	L [mm]	☒	EAN
43-320	300	0/100	5907558447170

TOPEX

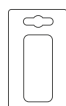

Ref.	L [mm]	☒	EAN
10A214	300	0/70	5902062103383

TOPEX

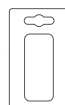

Ref.	L [mm]	W [mm]	info	N	☒	EAN
10A335	300	25	dwustronny	x5	0/50	5902062100177
10A333	300	25	dwustronny	x24	0/50	5902062104540
10A332-72	300	25	dwustronny	x72	0/10	5902062104571

TOP TOOLS

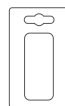

Ref.	L [mm]	W [mm]	☒	EAN
10A310	300	25	36/720	5902062104625

Brzeczot do piły kątovej

Mitre saw blade / Winkelsägeblatt / Полотно для углореза / Полотно до ступца / Fűrészlap gérvágóhoz / Lamă ferăstrău pentru tăiere sub unghi / Ostří do úhlové pily / Plátok pre pítku / Rezilni list za katno žago / Pjūkliukas kampų pjovimo pjūklui / Asmenis lenška zāģim / Saeleht / Pezere / List Pile za pilu pod kutom / List testere za testeru pod uglom / Láma για φαλτοπρίοιο / Hoja de sierra angular / Lama per sega angolare di precisione / Lámina / Lame de scie pour scie d'angle / Lemmet voor verstekzaag

NEO TOOLS



Ref.	L [mm]	☒	EAN
44-618	600	0/100	5907558408638



TOPEX

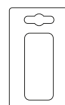

Ref.	L [mm]	☒	EAN
10A212	300	0/100	5902062103215

TOPEX

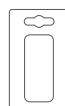

Ref.	☒	EAN
10A216	10/100	5902062032553

Skrzynka uciosowa

Mitre box / Schneidschablone / Стыцыно / Стыцыно / Gérláda / Ímbinare 'inclinatá lemn / Pokosnice / Vodtko ukosové / Jeralni predalčnik / Lovelis kampams pjauti / Trafarete leŋka zágim / Nurgalóikuskast / Пассамен / Šablona za kutove / Ger / Φαλτσοκούι / Guia de sierra / Dima per cornici / Caixa / Boîte de coupe / Houten tist

TOPEX



Ref.	L [mm]	W [mm]	H [mm]	☒	EAN
10A803	300	65	45	0/25	5902062100412

TOPEX



Ref.	L [mm]	W [mm]	H [mm]	☒	EAN
10A822	220	45	55	0/70	5902062101365
10A824	240	55	70	0/50	5902062101020
10A827	280	85	85	0/30	5902062202000

TOPEX



Ref.	L [mm]	W [mm]	H [mm]	☒	EAN
10A840	212	42	44	0/40	5902062103031
10A842	233	53	56	0/30	5902062103048
10A843	250	65	60	0/30	5902062103208
10A844	295	80	70	0/30	5902062103055
10A846	320	120	75	0/18	5902062103062

TOPEX



Ref.	L [mm]	W [mm]	H [mm]	info	☒	EAN
10A848	320	120	75	z zaciskami	0/18	5902062103079

Nożyce do prętów

Mini bolt cutter / Stabschere / Ножицы для проволоки / Ножицы для дроты / Csapszegvágó / Scule tăiere minişeruburi / Blokové nůžky / Strihač svorníkov / Škarje za žico / Mini žirkles armatūrai / Skrūvjokdis mini / Poldilóikur (váike) / Ножица за арматура / Škare za armaturu / Makaze za armaturu / Μίνι µινουλοκοφάτης / Cortavarillas / Tronchese / Tesoura p. Vergas / Cisaille à fers plats / Scharen voor stangen

NEO TOOLS



Ref.	L [mm]	ø [mm]	☒	EAN
31-018	450	8	6/12	5907558400564
31-024	600	10	1/6	5907558400571
31-030	750	12	0/4	5907558400588
31-035	900	16	0/2	5907558400595

NEO TOOLS



Ref.	L [mm]	ø [mm]	☒	EAN
31-019	450	8	0/10	5907558406979
31-025	600	10	0/10	5907558406986

TOPEX

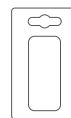

TOPEX



Ref.	L [mm]	Ø max. [mm]	☒	EAN
01A117	210	4	10/60	5902062011381

TOP TOOLS



Ref.	L [mm]	Ø max [mm]	☒	EAN
01A218	450	6	0/10	5902062010353
01A224	600	8	0/10	5902062010360

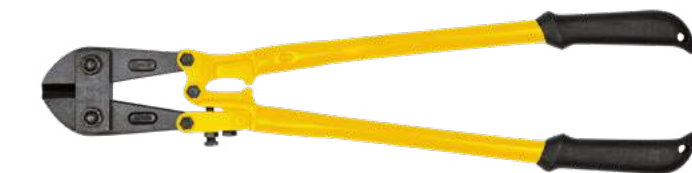

Ref.	L [mm]	Ø max. [mm]	☒	EAN
01A118	450	8	0/12	5902062011343
01A124	600	10	0/8	5902062011350
01A130	750	12	0/5	5902062011398
01A135	900	16	0/4	5902062011558

Nożyce do blachy

Tin snip / Blechscherer / Ножницы по жесту / Ножницы по листовому металлу / Lemezolló balos / Foarfecce tãiere tablã / Nůžky na plech / Nožnice na plech / Škarje za pločevino / Žirklés skardai / Grieznes skãrdam / Plekikããrid / Ножница за ламарина / Škare za lim / Makaze za lim / Ψαλίδι λαμαρίνας / Tijeras corta chapa / Cesoia / Tesoura para chapa / Cisaille coupe-tôle / Bliksharen

NEO
TOOLS

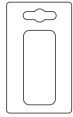

Ref.	typ/type/тип	L [mm]	☒	EAN
31-050	proste/straight/ прямые	250	6/48	5907558400601
31-055	prawe/right/правые	250	6/48	5907558400618
31-060	lewe/left/левые	250	6/48	5907558400625

NEO
TOOLS

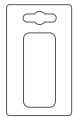

Material/Material/Материал	Grubość cięcia/Cutting thickness/ Толщина резки [mm]
Stal/Steel/Сталь	0,6
Stal hartowana HRC35/Hardened steel HRC35/ Закаленная сталь HRC35	0,3
Aluminium/Aluminium/Алюминий	1,0
Miedz/Brass/Медь	1,1
Tworzywo sztuczne/Plastic/Пластмасса	5,0

Ref.	L [mm]	☒	EAN
31-061	290	6/48	5907558409420

NEO
TOOLS

CrMo
steel

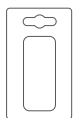

Ref.	typ/type/тип	L [mm]	☒	EAN
31-081	prawe/right/правые	260	6/36	5902062062994
31-083	prawe/right/правые	280	6/36	5902062063014
31-085	prawe/right/правые	300	6/24	5902062063038
31-082	lewe/left/левые	260	6/24	5902062063007
31-084	lewe/left/левые	280	6/24	5902062063021
31-086	lewe/left/левые	300	6/24	5902062063045

NEO
TOOLS

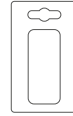

Ref.	typ/type/тип	L [mm]	☒	EAN
31-062	lewe/left/левые	240	6/36	5907558409550
31-063	prawe/right/правые	240	6/36	5907558409567

NEO
TOOLS

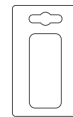

Material/Material/Материал	Grubość cięcia/Cutting thickness/ Толщина резки [mm]
Stal/Steel/Сталь	0,9
Stal hartowana HRC35/Hardened steel HRC35/ Закаленная сталь HRC35	0,7
Aluminium/Aluminium/Алюминий	1,0
Miedz/Brass/Медь	1,1
Tworzywo sztuczne/Plastic/Пластмасса	5,0

Ref.	L [mm]	☒	EAN
31-065	250	6/36	5907558407440

T TOPEX

CrV

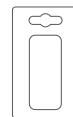

Ref.	L [mm]	info	☒	EAN
01A425	250	lewe/left/левые	6/48	5902062180353
01A426	250	prawe/right/правые	6/48	5902062180360
01A427	250	proste; stright; прямые	6/48	5902062180377

T TOPEX

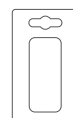

DIN
6438

Ref.	L [mm]	☒	EAN
01A440	250	6/36	5902062180513

Nožyce do blachy

Tin snip / Blechscher / Ножницы по жесту / Ножницы по листовому металлу / Lemezöll balos / Foarfece täiere tablä / Nůžky na plech / Nožnice na plech / Škarje za pločevino / Žirkles skardai / Grieznes skårdam / Plekikäärid / Ножница за ламаруна / Škare za lim / Makaze za lim / Ψαλίδι λαμαρίνας / Tijeras corta chapa / Cesóia / Tesoura para chapa / Cisaille coupe-tôle / Blikscharen

TOPEX



Ref.	L [mm]	☒	EAN
01A445	300	6/24	5902062180728

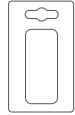

TOP TOOLS



Ref.	L [mm]	info	☒	EAN
01A552	260	stright	6/36	5902062180254
01A554	320	-	5/30	5902062180278

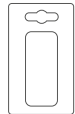

TOP TOOLS



Ref.	L [mm]	info	☒	EAN
01A998	250	left	10/50	5902062011725
01A999	250	right	10/50	5902062011732
01A997	250	stright	10/50	5902062010339

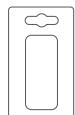

Nožyce do wykładzin

Carpet scissors / Schere für Teppichböden / Ножницы для резки напольных покрытий / Ножницы для килимового покриття / Szőnyegvágó olló / Foarfece pentru căptușeală / Nůžky na koberce / Nožnice na krytiny / Škarje za talne obloge / Žirkles kiliminei dangai / Škæres gridas seguma griešanai / Vaibakäärid / Ножница за мокет / Škare za podne podloge / Makaze za orlatu / Ψαλίδι για τάπητες βαπέδου / Tijeras para moqueta / Forbici ad uncino / Tesoura para tapetes / Cisaille à moquette / Schaar voor tapijten

NEO TOOLS



Ref.	L [mm]	D [mm]	☒	EAN
63-901	255	3,5	12/48	5907558405262

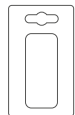

Çeđi zbrojarskie

Concretor's nippers / Клеши арматурные / Bewehrungszange / К्लीши в'язальні / Ηαράρ fogó / Clește fier / Armovaci klešte / Armaturne klešte / Žnyplės armatūrai / Armatūras knaibles / Jūsotslōiketangid / Арматурни клеци / Klijēšta za rezanje čelične žice / Klešta za armaturu / Τανάλια οικόδομου / Pinzas de ferrallista / Tenaglia per calcestruzzo / Turquês / Pince de ferrailleur / Vlechttang

NEO TOOLS



Ref.	L [mm]	☒	EAN
01-165	300	6/36	5907558425550



Çeđi dekarskie

Seaming pliers / Zange für Dachdecker / Клеци / К्लीци дахарські / Falçfogó 180° / Clește de tinichigerie / Pokryvačské klešte / Pokryvačské klešte / Krovске klešče / Replēs stogdengjiui / Jumņika knaibles / Plekikäärid / Ножница за ламаруна / Klijēšta za kronopokrivače / Krovna klešta / Τανάλια / Alicates de techador / Pinza piegatrice / Tenaz / Pince de couvreur / Nijptang

NEO TOOLS



Ref.	L [mm]	W [mm]	☒	EAN
31-070	275	60	5/25	5907558410785



NEO TOOLS



Ref.	L [mm]	W [mm]	☒	EAN
31-075	275	60	5/25	5907558410792



NEO TOOLS



Ref.	L [mm]	W [mm]	☒	EAN
31-080	275	60	5/25	5907558410808



Imadło

Vice / Schraubstock / Тиски / Леуцата / Satu / Menghinä / Svěrák / Zverák liatinový pevný / Primež / Spaustuvas / Kalts / Kruustangid / Менгеме / Radionička stega / Mengele / Μέγγενη / Tornillo de banco de precisión / Morsa girevole / Torno / Etao / Breekijzer

NEO TOOLS

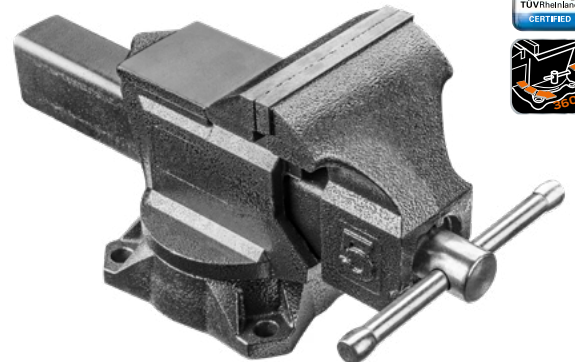

Ref.	W [mm]	Ra [mm]	☒	EAN
35-010	100	108	0/2	5907558400762
35-012	125	124	0/2	5907558400779
35-015	150	147	0/1	5907558400786



TOPEX

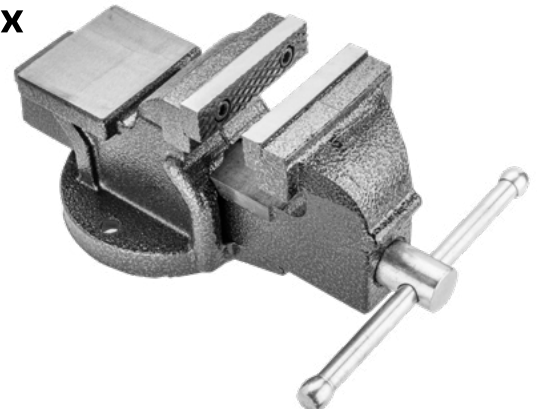

Ref.	W [mm]	Ra [mm]	☒	EAN
07A107	75	75	0/4	5902062043757
07A110	100	75	0/2	5902062040015
07A112	125	100	0/2	5902062040022
07A115	150	175	0/1	5902062040039



Imadło

Vice / Schraubstock / Tucku / Лещата / Satu / Menghinä / Svěrák / Zverák liatinový pevný / Primež / Spaustuvas / Kalts / Kruustangid / Мехеме / Radionička stega / Mengele / Μέγερνη / Tornillo de banco de precisión / Morsa girevole / Torno / Etao / Breekijzer

TOPEX

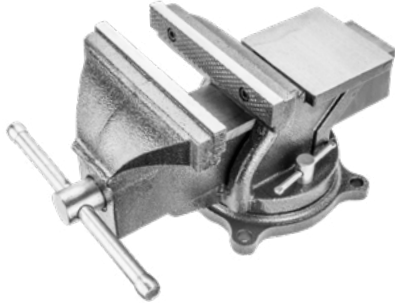

Ref.	W [mm]	Ra [mm]	☒	EAN
07A210	100	75	0/2	5902062040046
07A212	125	105	0/2	5902062040053
07A215	150	140	0/1	5902062040060

TOPEX



ALUMINIUM



Ref.	W [mm]	☒	EAN
07A307	57	0/18	5902062043863

TOPEX



ALUMINIUM



Ref.	W [mm]	Ra [mm]	☒	EAN
07A306	60	65	0/20	5902062043061

TOPEX



ALUMINIUM



Ref.	W [mm]	Ra [mm]	info	☒	EAN
07A310	100	95	możliwość mocowania do stołu	0/8	5902062043078

TOP TOOLS



Ref.	W [mm]	☒	EAN
07A206	60	0/10	5902062040077

Przecinak

Chisel / Meißel / Зубило / Зубуно / Laposvágó / Daltä / Sekáč / Sekáč / Dleto / Kirstukas / Cirtnis / Auguraud / Сенач / Rezač / Σεκάς / Cortafrio / Scalpello / Cortador / Burin / Beitel

NEO TOOLS

CrV steel

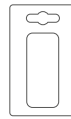

Ref.	L [mm]	W [mm]	☒	EAN
33-072	150	10	10/200	5907558413304
33-073	150	13	10/200	5907558413311
33-074	150	16	10/100	5907558413328

NEO TOOLS

CrV steel

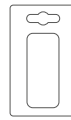

Ref.	L [mm]	ø [mm]	W [mm]	☒	EAN
33-081	300	18	22	6/24	5907558413144
33-082	300	18	35	6/24	5907558413151
33-083	300	18	50	6/24	5907558413168
33-084	300	20	75	6/24	5907558413175

TOPEX



CrV

Ref.	L [mm]	W [mm]	Ø [mm]	☒	EAN
03A136	300	23.5	16	0/24	5902062031075
03A139	300	27	19	0/24	5902062031525
03A149	400	27	19	0/20	5902062031532
03A159	500	27	19	0/15	5902062031556

TOPEX



CrV

Ref.	L [mm]	Ø [mm]	☒	EAN
03A170	300	19	6/36	5902062032072
03A171	300	25	6/24	5902062032089

TOPEX



CrV

Ref.	L [mm]	W [mm]	☒	EAN
03A320	200	20	12/72	5902062272003
03A325	250	22,8	6/36	5902062272508

TOP TOOLS



CrV

Ref.	W [mm]	Ø [mm]	☒	EAN
03A225	250	14	0/60	5902062030382
03A230	300	16	0/48	5902062030399
03A235	350	16	0/40	5902062030641

Przebijak

Punch / Lochhammer / Зубило / Пробувач / Hegyveséső / Preducea / Průbojník / Pribojnik / Prebijač / Skyłmuśys / Caurumsitis / Auguraud / Шило / Probijač / Probojac / Σμίλη / Puntero / Punzone con protezione / Saca-bocado / Perçoir / Puntslag

TOPEX

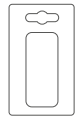

Ref.	L [mm]	Ø [mm]	⊠	EAN
03A169	400	19	0/20	5902062031563

TOPEX

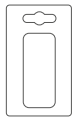

Ref.	L [mm]	Ø [mm]	⊠	EAN
03A180	300	19	4/24	5902062032096

TOP TOOLS



Ref.	W [mm]	Ø [mm]	⊠	EAN
03A245	250	14	0/60	5902062030405

Wybijak

Pin punch / Austreiber / Зубило / Вибувач / Stiftkiütő / Matriță de perforat / Vyrážeč / Vyrážač / Izbijač / Žymeklis (iškalimui) / Puansons / Auguraud / Избувач / Izbijač / Izbijač, prosekač / Σμίλη / Punzón / Punzone a punta / Chasse-goupille / Puntslag

NEO TOOLS

CrV steel

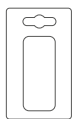

Ref.	L [mm]	ø [mm]	⊠	EAN
33-066	150	3	100/200	5907558413250
33-067	150	4	100/200	5907558413267
33-068	150	5	100/200	5907558413274
33-069	150	6	100/200	5907558413281

Punktak

Centre punch / Körner / Кернер / Кернер / Pontozó / Punctator / Důlčik / Raznik / Točkaló / Žymeklis / Punktisitis / Augumārgisti / Керна / Ručni bušač / Obeleživač / Πόντα σιδήρου / Punzón centrador / Punzone tondo / Punção / Pointeau / Doorslag

NEO TOOLS

CrV steel

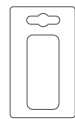

Ref.	L [mm]	ø [mm]	⊠	EAN
33-063	120	6	10/200	5907558413229
33-064	120	8	10/200	5907558413236

TOPEX

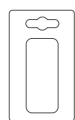

Ref.	L [mm]	Ø [mm]	⊠	EAN
03A441	100,0	6,3	25/100	5902062260147
03A442	127,5	9,4	25/100	5902062260383
03A445	152,0	12,7	25/100	5902062260123

Zestaw wybijałów i przycinaków

Pin punch and chisel set / Austreiber- und Meißel-Set / Набор пуносов и зубил / Набор зубил / Vágókészlet / Set de poansoane și dălți / Sada vyrážečů a sekáčů / Súprava pribojnikov a sekačov / Komplet izbijačev in dlet / Kalimo kaltų ir kirstukų rinkinys / Čiřpu spiedru un cirtņu komplekts / Tornide ja meislite komplekt / Комплект пуансонов и сеначи / Set izbijača i rezača / Komplet izbijača i sekača / Σετ ζουμπάδων και ομιλών / Juego de punzones y cortadores / Punzoni e scalpelli / Kit de mnadris e cortadores / Jeu de chasse-goupilles et de burins / Set van puntslagen en knippers

NEO TOOLS

CrMo steel x5

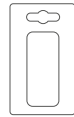

Ref.	⊠	EAN
33-060	10/40	5907558407457

NEO TOOLS

CrV steel

x6

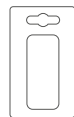

Ref.	L [mm]	⊠	EAN
33-061	300	6/36	5907558413205

NEO TOOLS

CrV steel x12

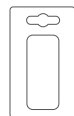

Ref.	L [mm]	⊠	EAN
33-062	300	6/12	5907558413212

Dobijaki do gwoździ

Nail punch set / Nageltreiber / Добойники для гвоздеў / Пробувач для цвяхів, набір / Stiftkiütő készlet / Set ciocane de găurit / Zatloukač hřebíků / Súprava pribojnikov / Žebjalnik / Viniakalis / Punktisitis naglām / Naelalöömiskomplekt / За́мбу / Probijači set / Probijac set / Ζουμπάς για καρφιά / Punzones para clavos / Punzoni per chiodi / Punção para cravar / Chasse-clous / Spijkerpons

TOPEX

x4

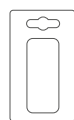

Ref.	Ø [mm]	⊠	EAN
03A440	0,8 - 3,2	12/72	5902062031396

Łom

Wrecking bar / Brecheisen / Лом / Лом / Ládabontó / Rangő montare / Páčadlo / Páčadlo / Želbjarska babica / Laužtuvas / Lauznis / Kang / Козу крак / Poluga za čavle / Пајсер / Ασπίς / Palanca / Barra da demolição / Pé-de-cabra / Pied-de-biche / Breekijzer

NEO TOOLS



Ref.	L [mm]	⊠	EAN
29-040	460	1/5	5907558407327

NEO TOOLS



Ref.	L [mm]	∅ [mm]	⊠	EAN
29-041	400	16	0/5	5907558409529
29-061	600	19	0/5	5907558407310
29-091	900	19	5/5	5907558407327
29-092	1000	19	1/5	5907558409536

TOPEX



Ref.	L [mm]	∅ [mm]	⊠	EAN
04A130	300	21x10	0/20	5902062041302
04A140	400	21x11	0/20	5902062031068
04A160	600	29x16	0/10	5902062031129
04A175	750	30x16	0/10	5902062045041
04A190	900	30x16	0/10	5902062045058

TOPEX



Ref.	L [mm]	∅ [mm]	⊠	EAN
04A240	400	16	0/12	5902062045065
04A250	500	16	0/12	5902062045072
04A260	600	16	0/12	5902062030429
04A280	800	19	0/10	5902062031389
04A210	1000	18	0/10	5902062045089
04A212	1200	18	0/10	5902062045096

TOPEX



Ref.	L [mm]	∅ [mm]	info	⊠	EAN
04A312	1200	25	zebrowany	0/1	5902062031280
04A315	1500	25	zebrowany	0/1	5902062031297

TOP TOOLS

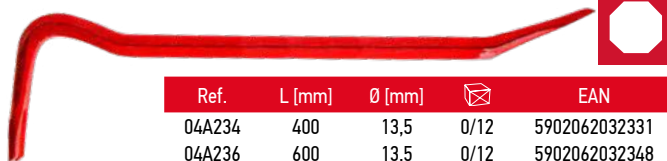

Ref.	L [mm]	∅ [mm]	⊠	EAN
04A234	400	13,5	0/12	5902062032331
04A236	600	13,5	0/12	5902062032348
04A239	900	15,5	0/12	5902062032355

TOP TOOLS



Ref.	L [mm]	∅ [mm]	⊠	EAN
04A230	300	13,5	0/30	5902062030481

Wyciągacz do gwoździ

Wonder bar / Nadel-Auszieher / Γεωζόδοερ / Цвяходер / Ládabontó / Dispozitiv de scos cuie / Ranga / Vytahováč hřebíků / Vytahovač klincov / Lomilka za žebje / Viniatraukis / Naglu izvilcājs / Naelasörg / Ключ козу крак / Izvlakač za čavle / Alatka za vadenje eksera / Προκοβήγατης / Barra sacaclavos / Paranco a barra / Saca-pernos / Extracteur de clous / Spijcktrekker

NEO TOOLS



Ref.	L [mm]	⊠	EAN
29-030	380	0/5	5907558407310

Pilniki do metalu

Steel file set / Metallfeilen / Напильники по металлу / Пилъници по металу, набор / Reszoló készlet / Set tăietoare metal / Pilnik na kov / Súprava pilníkov / Konice za kovino / Dildés metalui / Vile metálam / Terasviliide komplekt / Пилу компл. / Turpija za metal set / Turpije za metal / Συλλογή λιμών για μέταλλο / Limas para metal / Set lime per metallo / Lima para metal / Lime à métal / Metaalvlijen

NEO TOOLS

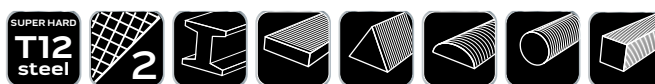

Ref.	L [mm]	⊠	EAN
37-610	200	4/16	5907558407433

NEO TOOLS



Ref.	L [mm]	⊠	EAN
37-022	200/2	■	10/80 5907558400847
37-122	200/2	●	10/80 5907558400939
37-222	200/2	●	10/80 5907558401028
37-322	200/2	■	10/80 5907558401110
37-422	200/2	▲	10/80 5907558401202

NEO TOOLS



Ref.	L [mm]	⊠	EAN
37-605	200	4/16	5907558407426

Pilnik do metalu

Steel file / Metallfeile / Напильник по металлу / Пилынок по металу / Reszelő lapos / Täietoare metal / Pilnik na kov / Pilnik polkruhový / Konica za kovino / Dildé metalui / Vile metálam / Terasvii / Пила / Turpija za metal / Turpije za metal / Λίμα για μέταλλο / Lima para metal / Lima per acciaio / Lima para metal / Lime à métal / Metaalvijl

T TOPEX

T12



Ref.	L [mm]	info	☒	EAN
06A721	200/2	—	10/60	5902062101662
06A722	200/2	—	10/60	5902062101679
06A723	200/2	●	10/80	5902062101686
06A724	200/2	●	10/80	5902062101693
06A725	200/2	▲	10/60	5902062101709

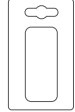

T TOPEX

T12



Ref.	L [mm]	N	info	☒	EAN
06A130	200/2	x3	—	20/20	5902062102638
06A230	200/2	x3	—	10/20	5902062101099
06A250	200/2	x5	—	10/20	5902062101105

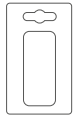

TOP TOOLS



Ref.	L [mm]	☒	EAN
06A430	200	25/50	5902062100740

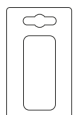

Pilniki iglaki

Needle files / Igel-Pfeilen / Нащфулу / Напильки голчасти / Túreszelő készlet / Mini-pile / Pilníky jehlové / Pilníky ihlové / Iglaste pile / Dildés, ylos / Adatviles / Nöelviild / Vzenemu nunu / Iglíçaste turpije / Iglá turpije / Λίμες μοντελιαιουύ / Limas de aguja / Set lime ad ago per metallo / Limas / Limes aiguilles / Naaldvijlen

T TOPEX

x6



Ref.	L [mm]	Ø [mm]	☒	EAN
06A010	150	3	25/100	5902062610201

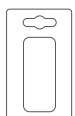

Pilniki iglaki

Needle files / Igel-Pfeilen / Нащфулу / Напильки голчасти / Túreszelő készlet / Mini-pile / Pilníky jehlové / Pilníky ihlové / Iglaste pile / Dildés, ylos / Adatviles / Nöelviild / Vzenemu nunu / Iglíçaste turpije / Iglá turpije / Λίμες μοντελιαιουύ / Limas de aguja / Set lime ad ago per metallo / Limas / Limes aiguilles / Naaldvijlen

T TOPEX

x5



Ref.	L [mm]	Ø [mm]	☒	EAN
06A000	140	4,0	10/300	5902062103222

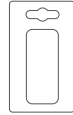

T TOPEX

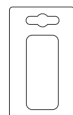

Ref.	L [mm]	Ø [mm]	info	☒	EAN
06A020	140	3	bez uchwytu	25/100	5902062610102
06A015	140	3	z uchwytem	25/100	5902062610157

TOP TOOLS



x6

Ref.	☒	EAN
06A625	30/120	5902062037664

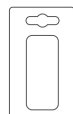

TOP TOOLS

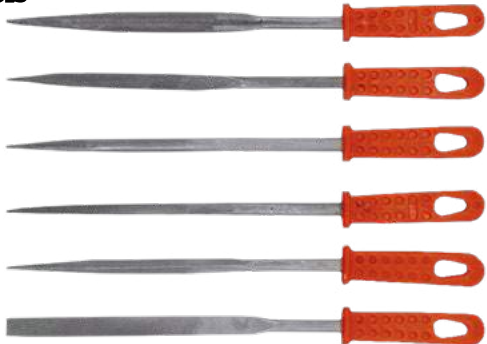

x6

Ref.	☒	EAN
06A025	30/120	5902062100030

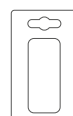

Pilnik do drewna

Wood rasp / Holzfeile / Рашипель по древу / Рашипель / Faráspoly lapos / Raspel lemn / Pilnik na dřevo / Rašpla plochá / Konică za les / Dildés medžiui / Vile kokam / Puiduraspel / Пана / Turpija za drvo / Turpija za drvo / Ξύλινη ράσα / Lima para madera / Raspa per legno / Lima para madeira / Râpe à bois / Houtvijl

NEO
TOOLS

SUPER HARD
T12
steel



Ref.	L [mm]		⊠	EAN
37-540	200	—	10/100	5907558401257
37-545	200	●	10/100	5907558401264
37-550	200	●	10/100	5907558401271

NEO
TOOLS

SUPER HARD
T12
steel



Ref.	L [mm]	⊠	EAN
37-600	200	4/16	5907558407419

TOPEX

T12

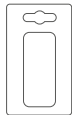

Ref.	L [mm]	info	⊠	EAN
06A831	200	—	10/60	5902062101716
06A832	200	●	10/60	5902062101723
06A833	200	●	10/80	5902062101730

TOPEX

x31

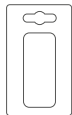

Ref.	L [mm]	⊠	EAN
06A330	200	10/20	5902062101112

TOP TOOLS

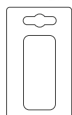

Ref.	L [mm]	⊠	EAN
06A530	200	25/50	5902062100023

Pilnik do ostrzenia łańcuchów

Chain sharpening file / Feile zum Kettenschärfen / Напильник для заточки цепи / Напилок для гостріння ланцюга / Lánkfűrészeszelő / Pile pentru ascuțirea lanturilor / Pilnik pro ostření pilových řetězů / Pilnik na brúsenie reťazí / Brusilnik za verige / Pjüklý grandinių galandinimo dildė / Vile ķēžu asināšana / Ketteritusviild / Пана за острене на вервезу / Turpija za oštrenje lanca / Turpije za oštrenje lanaca / Ακόνια αλυσίδας / Lima para afilar cadenas / Lima affilata per catena / Kettingvijl / Lima para afiar correntes

TOPEX

GCr15

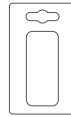

Ref.	L [mm]	Ø [mm]	⊠	EAN
06A786	200	4,0	10/100	5902062103284
06A788	200	4,8	10/100	5902062103291

Dłuta

Chisels / Beitel / Стамески / Зубуна / Favésó készlet / Dalta / Dláta / Dláta / Dleta / Kaltai / Kalti / Peitild / Дрѐма / Dlijeta / Dleta / Koničia / Formones / Set scalpelli / Conjunto de Raspadores / Jeu de ciseaux / Beitel

TOPEX



Ref.	W [mm]	⊠	EAN
09A106	6	12/120	5902062101129
09A108	8	12/120	5902062101136
09A110	10	12/120	5902062101143
09A112	12	12/120	5902062101150
09A114	14	12/120	5902062101167
09A115	15	0/120	5902062101174
09A116	16	12/120	5902062101181
09A118	18	12/96	5902062101198
09A120	20	12/96	5902062101204
09A122	22	12/72	5902062101211
09A125	25	12/72	5902062101228
09A132	32	12/72	5902062101235
09A138	38	0/48	5902062101242

TOPEX

CrV

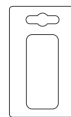

Ref.	W [mm]	⊠	EAN
09A410	10	6/48	5902062102959
09A412	12	6/48	5902062102966
09A414	14	6/48	5902062102973
09A416	16	6/48	5902062102980
09A420	20	6/48	5902062102997
09A425	25	6/48	5902062103000
09A432	32	6/48	5902062103017

TOPEX

x4

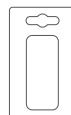

Ref.	W [mm]	⊠	EAN
09A310	6, 12, 18, 24	5/30	5902062102874

Dłuta

Chisels / Beitel / Стамески / Зубила / Favésó készlet / Dalta / Dláta / Dláta / Dleta / Kaltai / Kalti / Peitlid / Дрѐма / Dlijeta / Dleta / Koniđia / Formones / Set scalpelli / Conjunto de Raspadores / Jeu de ciseaux / Beitels

TOP TOOLS

x4

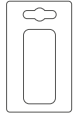
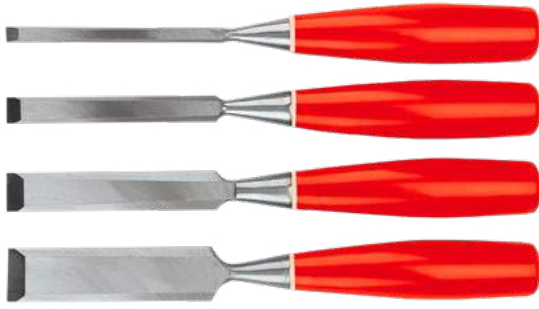

Ref.	W [mm]	☒	EAN
09A322	6, 12, 18, 24	0/40	5902062104434

TOP TOOLS

x4

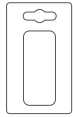

Ref.	W [mm]	☒	EAN
09A320	6, 12, 18, 24	0/36	5902062100092

Ścisk narożnikowy

Angle clamp / Winkelzwinge / Струбцина угловая / Струбцина нарижна / Sarokszorító / Clemă unghiulară / Rohová spojka / Zvierka rohová / Kotna spona / Gnybtai kampiniai / Spiles stūra / Nurgaklamber / Стяга ъглова / Kutna stega / Ugaona stega / Γωνιακός σφιγκτήρας / Tornillo de banco de esquina / Morsetto angolare / Grampo de canto / Serre-joint angulaire / Hoekklemmen

TOPEX

ALUMINIUM



Ref.	L [mm]	W [mm]	☒	EAN
12A300	65	70	0/14	5902062705259

TOP TOOLS

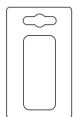

Ref.	L [mm]	W [mm]	☒	EAN
12A305	75	75	10/80	5902062101082

Ścisk stolarski

F-clamp / Schraubzwinge / Струбцина столярная / Струбцина столярна / Gyorscsavarszorító / Clemă în forma F / Truhlářská svorka / Zvierka stolárska / Mizarska spona / Spaustuvos staliui / Spiles galdnieka / F-klamber / Стяга / Stolarska stega / Stolarska stega / Σφιγκτήρας ξυλουργού / Sargento / Morsetto a F / Grampo de marcenaria / Serre-joint de menuisier / Timmermansklemmen

NEO TOOLS



Ref.	L [mm]	W [mm]	☒	EAN
45-220	200	120	2/6	5907558435481
45-230	300	120	2/6	5907558435498
45-240	400	120	2/6	5907558435504

NEO TOOLS



Ref.	L [mm]	W [mm]	☒	EAN
45-450	150	50	0/20	5902062062796
45-451	250	50	0/20	5902062062802
45-452	300	80	0/10	5902062062819
45-453	300	120	0/10	5902062062826
45-454	500	120	0/10	5902062062833
45-455	800	120	0/6	5902062062840
45-456	1000	120	0/6	5902062062857
45-457	1500	120	0/4	5902062062864

TOPEX

DIN 5117



Ref.	L [mm]	W [mm]	☒	EAN
12A100	150	50	0/25	5902062102928
12A102	250	50	0/25	5902062102935
12A120	300	80	0/25	5902062102799
12A123	300	120	0/10	5902062102805
12A125	500	120	0/10	5902062102812
12A128	800	120	0/6	5902062102829
12A130	1000	120	0/6	5902062102836
12A135	1500	120	0/6	5902062102904

TOP TOOLS

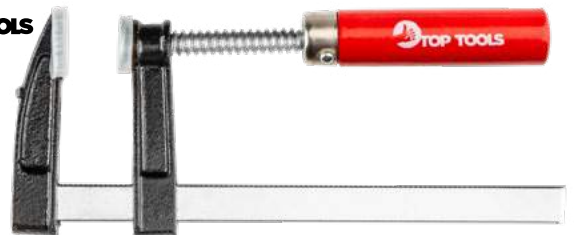

Ref.	L [mm]	W [mm]	info	☒	EAN
12A200	150	50		0/50	5902062100467
12A215	150	50	× 2	0/25	5902062100504
12A201	200	50		0/50	5902062100474
12A216	200	50	× 2	0/25	5902062100511
12A202	250	50		0/50	5902062100481
12A203	300	50		0/50	5902062100498
12A220	300	80		0/25	5902062100528
12A223	300	120		0/20	5902062100535
12A225	500	120		0/10	5902062100542
12A228	800	120		0/6	5902062100559

Ścisk taśmowy

Belt clamp / Bandzwinke / Струбцина ленточная / Струбцина стрічкова / Parketta összehúzó / Sistem rulant cleme / Pásová svorka / Zvierka rámková / Jermenska spona / Spaustuvus juostinis / Spīles lentveida / Rihmaklamber / Стяга лентова / Stega rojas / Stega rojas / Σφιγκτήρας λωρίδας / Prensa de cinta / Morsetto a nastro / Grampo de fita / Serre-joint à bande / Bandklemmen

TOPEX

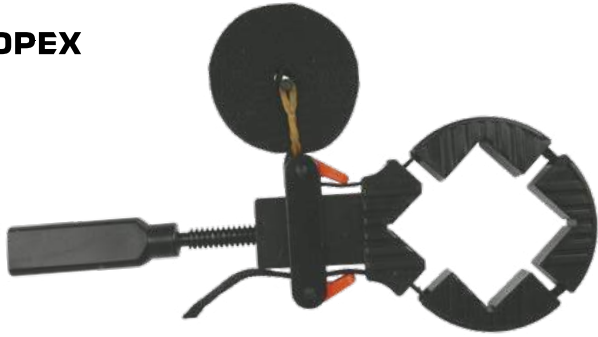

Ref.	L [m]	W [mm]	D [mm]	☒	EAN
12A340	4	25	1	0/20	5902062102300

Ścisk automatyczny

Quick clamp / Automatizwinke / Струбцина автоматическая / Струбцина столярна / Kézi szorító / Clemă cu acțiune rapidă / Automatická svorka / Zvierka automatická / Avtomatska spona / Spaustuvus / Spīles automātiskās / Kiirklamber / Стяга / Stolarska stega / Stolarska stega / Σφιγκτήρας ελαστικών / Sargento automático / Morsetto rapido / Grampo automático / Serre-joint automatique / Automatische klemmen

TOPEX



Ref.	L [mm]	W [mm]	☒	EAN
12A515	150	60	6/24	5902062125156
12A520	200	60	6/24	5902062125200
12A530	300	60	5/30	5902062125309
12A545	450	60	6/12	5902062125453
12A560	600	60	6/12	5902062125606
12A575	750	60	6/12	5902062125750
12A590	900	60	5/10	5902062125903



TOPEX

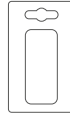

Ref.	L [m]	W [mm]	D [mm]	☒	EAN
12A350	5	25	1	10/20	5902062102898

Ścisk nylonowy

Nylon quick clamp / Nylon-Schraubzwinke / Струбцина нейлоновая / Струбцина нейлонова / Kézi szorító / Menghină de nylon / Svorka nylonová / Zvierka nylonová / Najlonska spona / Plastmasiniai spaustai / Neilona spīles / Nailonpitskruvi / Наїлоново менгеме / Najlonska stezaljka / Najlonski stezači / Σφιγκτήρας πλαστικός / Prensa en "C" de nilón / Morsetto Nylon / Grampo de nylon / Serre-joint nylon / Nylon klemmen

TOPEX



Ref.	L [mm]	☒	EAN
12A380	50	24/144	5902062123800
12A382	75	8/48	5902062123824
12A384	100	8/48	5902062123848

Ścisk sprężynowy

Spring clamp / Federzwinke / Зажим пружинный / Затискач пружинный / Szorítócsipesz / Bornă elastică / Pružinová svorka / Zvierka / Natezna spona / Gnybtai spyruokliniai / Spīles / Vedruklamber / Стяга / Stega / Stega special / Σφιγκτήρας ελαστικών / Sargento / Morsetto a scatto / Grampo de mola / Serre-joint à ressort / Veerklemmen

TOP TOOLS



Ref.	L [mm]	☒	EAN
12A410	100	0/250	5902062102317
12A415	150	0/100	5902062102324
12A422	225	0/100	5902062102331

Ściski modelarskie

G clamps / Klemmlänge / Струбцины / Струбцина мініатюрна / Sarokszorító / Menghine de modelari, tip G / Svorky modelárské / Modelárske zvierky / Modelarske sponne / Spaustai modeliavimui / Modelēšanas spīles / G-pitskruid / Менгеме за моделуери / Rezbarske stezaljke / Modelarski stezači / Σφιγκτήρας μοντελιού / Prensas en „C” / Morsetto angolare / Grampos p. Modelação / Serre-joint de modelage / G-klemmen

TOP TOOLS



Ref.	L [mm]	☒	EAN
12A375	25, 50, 75	0/30	5902062102720

x3

Kielnia

Brick trowel / Kelle / Кельма / Кельня / Sarokkanál / Mistrie / Zednická lžice / Keflja murárska / Zidarska lopatica / Mentelè / Kelle / Müürikellu / Мучпуя 200mm / Žlica zidarska / Mistrija zidarska / Мушті / Paleta de albañil / Cazzuola / Colher de pedreiro / Truelle / Troffel

NEO
TOOLS



Ref.	L [mm]	⊠	EAN
50-101	180	0/50	5907558438352
50-102	200	0/50	5907558438369

NEO
TOOLS



Ref.	L [mm]	W [mm]	⊠	EAN
50-105	190	134	0/50	5907558438956

NEO
TOOLS



Ref.	L [mm]	W [mm]	⊠	EAN
50-121	140	80	0/50	5907558438925

NEO
TOOLS



Ref.	L [mm]	W [mm]	⊠	EAN
50-122	165	54	0/50	5907558438932
50-123	165	54	0/50	5907558438949

NEO
TOOLS



Ref.	L [mm]	⊠	EAN
50-111	8	0/50	5907558438376
50-112	10	0/50	5907558438383
50-113	12	0/50	5907558438390

NEO
TOOLS



Ref.	L [mm]	⊠	EAN
50-141	140	0/50	5907558438253
50-142	160	0/50	5907558438260
50-143	180	0/25	5907558438277

NEO
TOOLS



Ref.	L [mm]	⊠	EAN
50-131	60	0/50	5907558438178
50-132	80	0/50	5907558438185
50-133	100	0/50	5907558438192
50-134	120	0/50	5907558438208

NEO
TOOLS



Ref.	L [mm]	⊠	EAN
50-151	80	0/50	5907558438314
50-152	80	0/50	5907558438321

NEO
TOOLS



Ref.	L [mm]	⊠	EAN
50-146	140	0/50	5907558438284
50-147	160	0/50	5907558438291
50-148	180	0/25	5907558438307

NEO
TOOLS



Ref.	L [mm]	⊠	EAN
50-136	60	0/50	5907558438215
50-137	80	0/50	5907558438222
50-138	100	0/50	5907558438239
50-139	120	0/50	5907558438246

NEO
TOOLS



Ref.	L [mm]	⊠	EAN
50-155	80	0/50	5907558438338
50-156	80	0/50	5907558438345



Kielnia

Brick trowel / Kelle / Кельма / Кельня / Sarokkanál / Mistrie / Zednická lžice / Kefňa murárska / Zidarska lopatica / Mentelè / Kelle / Miiirikellu / Мучпуя 200mm / Žlica zidarska / Mistrinja zidarska / Муотпи / Paleta de albañil / Cazzuola / Colher de pedreiro / Truelle / Troffel

TOPEX

STAINLESS
STEEL

TOPEX

TOPEX



Ref.	L [mm]	W [mm]	☒	EAN
13A100	180	180	6/60	5902062091918



Ref.	L [mm]	W [mm]	☒	EAN
13A103	200	185	12/60	5902062092373



Ref.	L [mm]	W [mm]	☒	EAN
13A119	200	140	12/60	5902062092380

TOPEX

TOPEX

TOPEX



Ref.	L [mm]	W [mm]	☒	EAN
13A800	160	80	0/30	5902062091635



Ref.	L [mm]	W [mm]	☒	EAN
13A805	100	60	0/30	5902062091642
13A810	110	80	0/30	5902062091659

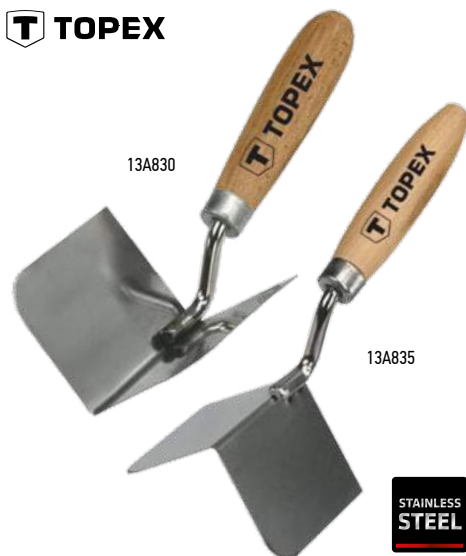

Ref.	L [mm]	W [mm]	☒	EAN
13A830	80	60	0/50	5902062091697
13A835	80	60	0/50	5902062091703

TOPEX

TOP TOOLS

TOP TOOLS



Ref.	L [mm]	W [mm]	☒	EAN
13A587	140	80	0/30	5902062048622
13A588	160	20	0/30	5902062048639



Ref.	L [mm]	☒	EAN
13A102	200x175	0/120	5902062090447



Ref.	[mm]	☒	EAN
13A118	200x140	12/120	5902062090461

STAINLESS
STEEL

Paca

Float / Reibbrett / Терка / Терка / Acélsimító / Lopátčič / Hladitko / Hladitka nerez / Gladilna žlica / Glaistyklé / Rívdélis / Ujuk / Манамашка / Gleter / Perdaska / Трѣбиѝ / Talocha / Frattazzo / Desempenadeira / Taloche / Hoektraffel

NEO
TOOLS



PVC

Ergonomic
beechen
handle

Ref.	L [mm]	W [mm]	☒	EAN
50-209	270	130	0/10	5907558438666

NEO
TOOLS



6 YEARS
GUARANTEE

STAINLESS
steel

Ergonomic
beechen
handle

Ref.	L [mm]	W [mm]	☒	EAN
50-201	270	125	0/24	5907558438574

NEO
TOOLS



6 YEARS
GUARANTEE

STAINLESS
steel

Ergonomic
beechen
handle

Ref.	L [mm]	W [mm]	☒	EAN
50-161	270	128	0/24	5907558438406

NEO
TOOLS



6 YEARS
GUARANTEE

STAINLESS
steel

Ergonomic
bi-material
handle

Ref.	L [mm]	W [mm]	☒	EAN
50-166	270	128	0/24	5907558438444

NEO
TOOLS



6 YEARS
GUARANTEE

STAINLESS
steel

Ergonomic
bi-material
handle

Ref.	L [mm]	W [mm]	☒	EAN
50-160	270	97x80	0/20	5907558438963

NEO
TOOLS



6 YEARS
GUARANTEE

STAINLESS
steel

Ergonomic
beechen
handle

Ref.	L [mm]	W [mm]	☒	EAN
50-171	380	128	0/10	5907558438482
50-181	480	128	0/10	5907558438529
50-191	580	128	0/18	5907558438550
50-196	680	128	0/18	5907558438567

TOPEX



STAINLESS
STEEL

Ref.	L [mm]	W [mm]	☒	EAN
13A228	280	130	0/30	5902062090478

TOPEX



6 YEARS
GUARANTEE

Ref.	L [mm]	W [mm]	☒	EAN
08A115	210	105	0/30	5902062091154

TOPEX



Ref.	L [mm]	W [mm]	info	☒	EAN
13A340	260	130	gładka	0/24	5902062091093

TOPEX

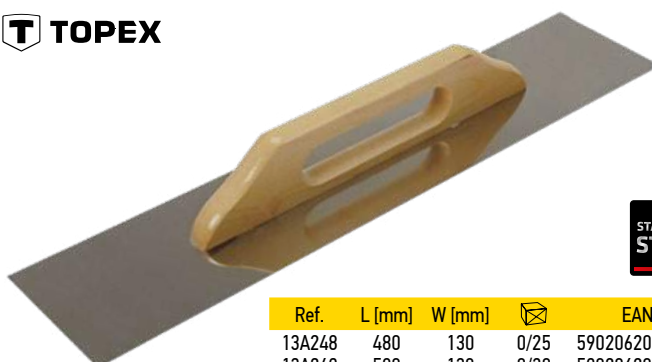

STAINLESS
STEEL

Ref.	L [mm]	W [mm]	☒	EAN
13A248	480	130	0/25	5902062091086
13A249	580	130	0/30	5902062092250
13A250	680	130	0/30	5902062092267

Paca z zębami

Serrated float / Reibebrett mit Zähnen / Терка с зубьями / Терка зубчаста / Acélsimító rozsdamentes / Drisčá cu dinți / Hladitko zub / Hladidlo so zubami / Gladilka z zobmi / Dantyta trintuvé / Rive ar zobiem / Hammaskellu / Назъбена маламашка / Zupčasti plovak / Glačalica sa zubima / Σπάτουλα χτένα / Talocha con peine / Frattazzo / Desempenadeira com dentes / Taloché à dents / Plakspaan met vertanding

NEO
TOOLS



NEO
TOOLS



Ref.	L [mm]	W [mm]	a x b x c [mm]	☒	EAN
50-162	270	128	6 x 6 x 6	0/24	5907558438413
50-163	270	128	8 x 8 x 8	0/24	5907558438420
50-164	270	128	10 x 10 x 10	0/24	5907558438437

Ref.	L [mm]	W [mm]	a x b x c [mm]	☒	EAN
50-167	270	128	6 x 6 x 6	0/24	5907558438451
50-168	270	128	8 x 8 x 8	0/24	5907558438468
50-169	270	128	10 x 10 x 10	0/24	5907558438475

NEO
TOOLS



NEO
TOOLS



Ref.	L [mm]	W [mm]	a x b x c [mm]	☒	EAN
50-203	270	125	8 x 8 x 8	0/24	5907558438598
50-204	270	125	6 x 6 x 6	0/24	5907558438611
50-205	270	125	4 x 4 x 4	0/24	5907558438710
50-202	270	125	10 x 10 x 10	0/24	5907558438581

Ref.	L [mm]	W [mm]	a x b x c [mm]	☒	EAN
50-172	380	128	6 x 6 x 6	0/10	5907558438499
50-173	380	128	8 x 8 x 8	0/10	5907558438505
50-174	380	128	10 x 10 x 10	0/10	5907558438512
50-182	480	128	8 x 8 x 8	0/10	5907558438536
50-183	480	128	10 x 10 x 10	0/10	5907558438543

TOPEX

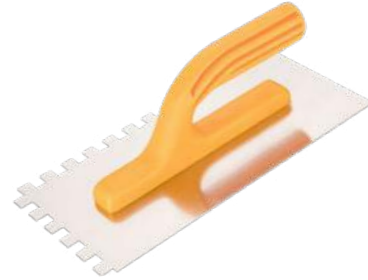

Ref.	L [mm]	W [mm]	a x b x c [mm]	☒	EAN
13A284	280	130	4 x 4 x 4	0/30	5902062090485
13A286	280	130	6 x 6 x 6	10/30	5902062090492
13A288	280	130	8 x 8 x 8	0/30	5902062090508
13A290	280	130	10x10x10	0/30	5902062090515

Paca styropianowa

Polystyren float / Styroporreibrett / Терка пенополистироловая / Терка полистиролна / Simító hungarocell / Lopičiča polistiren / Polystyrenové hladitko / Hladitko polystyrenové / Gladilna žlica za stiropor / Trintuvé glaištui / Rīvdēlis putuplasta / Ujuk (poliüstireen) / Маламашка / Gladilo / Perdaska / Τριβίδι από πολυεστέρα / Talocha de polièstireno / Frattazzo / Desempenadeira de polièstireno extruído / Taloché polystyrène / Polystyren troffel

NEO
TOOLS

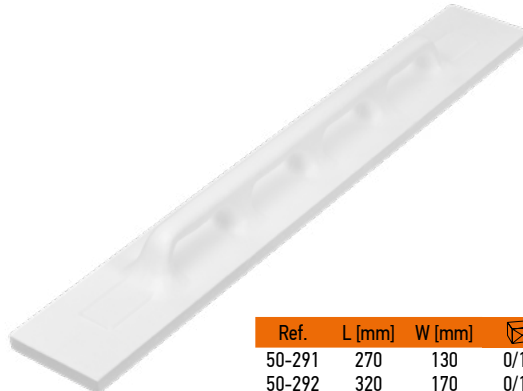

Ref.	L [mm]	W [mm]	☒	EAN
50-291	270	130	0/10	5907558438635
50-292	320	170	0/10	5907558438826
50-293	500	140	0/10	5907558438697
50-294	600	130	0/10	5907558438734
50-295	700	140	0/10	5907558438864

Paca z gąbką

Float with sponge / Reibebrett mit Schwamm / Терка с губкой / Терка з губкою / Szivacsos simító / Drisčá cu burete / Hladitko s houbou / Hladidlo so špongiou / Gladilka z gobo / Trintuvé su kempine / Rive ar sūkli / Käsnağa kellu / Маламашка с зъба / Plovak sa spužvom / Glačalica sa sunderom / Σπάτουλα φινιρίσματος με σπόγγο / Llana con esponja / Frattazzo / Desempenadeira com esponja / Taloché à éponge / Plakspaan met spons

NEO
TOOLS



Ref.	L [mm]	W [mm]	float [mm]	☒	EAN
50-224	280	140	30	0/10	5907558438703

NEO
TOOLS

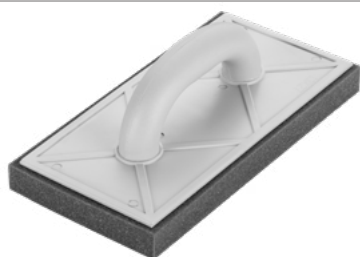

Ref.	L [mm]	W [mm]	float [mm]	☒	EAN
50-226	280	140	25	0/10	5907558438840

NEO
TOOLS



Ref.	L [mm]	W [mm]	float SMPX [mm]	☒	EAN
50-225	280	140	25	0/10	5907558438789

Paca z gąbką hydrochlonna

Float with special sponge / Reibebrett mit Schramm wasseraufsaugend / Терка влазопоглощающей губкой / Тертка з гігроскопічною губкою / Műanyag simító / Driščă cu burete hidroabsorbant / Hladítko s hydroabsorbční houbou / Hladidlo hydro mlátno / Gladilka z vodovpojno gobo / Trintuvé su vanderj sugerianča kempine / Rive ar mitrumu uszúcsóú súkli / Vettimava käsnağa kellu / Маламашка с влазопогльщаща гъба / Plovak s hidroklorom spružvom / Glačalica sa upijajućim sunderom / Σπάτουλα φινιρίματος με απορροφητικό απόγγο / Talocha de plástico con esponja hidroabsorbente / Frattazzo / Desempenadeira com esponja absorvente / Taloché à éponge avide d'eau / Plaksraan met absorberende spons

NEO
TOOLS



TOPEX



Ref.	L [mm]	W [mm]	float [mm]	☒	EAN
50-223	280	140	30	0/10	5907558438703

Ref.	L [mm]	W [mm]	☒	EAN
13A338	260	130	0/20	5902062092199

Paca z gąbką gęstą

Float with dense sponge / Reibebrett mit Schramm dick / Терка с плотной губкой / Тертка зі щільною губкою / Műanyag simító / Driščă cu burete dens / Hladítko s hustou houbou / Hladidlo so špongiou husté / Gladilka z gosto gobo / Trintuvé su tankios tekstūros kempine / Rive ar blīvu súkli / Tiheda käsnağa kellu / Маламашка с гъста гъба / Plovak s gustom spružvom / Glačalica sa gustim sunderom / Σπάτουλα φινιρίματος με συμπαγή απόγγο / Talocha de plástico con esponja densa / Frattazzo / Desempenadeira com esponja densa / Taloché à éponge dense / Plaksraan met dichte spons

NEO
TOOLS



TOPEX



Ref.	L [mm]	W [mm]	float [mm]	☒	EAN
50-221	280	140	25	0/10	5907558438659

Ref.	L [mm]	W [mm]	info	☒	EAN
13A336	260	130	gąbka gęsta	0/20	5902062092182

Paca z gąbką gumową

Float with rubber sponge / Reibebrett mit Gummischwamm / Терка с резиновой губкой / Тертка з гумовою губкою / Műanyag simító / Driščă cu burete de cauciuc / Hladítko s pryžovou houbou / Hladidlo so špongiou gumové / Gladilka z gumijasto gobo / Trintuvé su gumine kempine / Rive ar gumijas súkli / Kummikäsnağa kellu / Маламашка с гумена гъба / Plovak s gumenot spružvom / Glačalica sa gumenim sunderom / Σπάτουλα φινιρίματος με ελαστικό απόγγο / Talocha de plástico con esponja de goma / Frattazzo / Desempenadeira com esponja de borracha / Taloché à éponge en caoutchouc / Plaksraan met rubberen spons

NEO
TOOLS



TOPEX



Ref.	L [mm]	W [mm]	float [mm]	☒	EAN
50-227	280	140	8	0/10	5907558438895
50-222	280	140	18	0/10	5907558438673

Ref.	L [mm]	W [mm]	float [mm]	☒	EAN
13A342	260	120	18	0/20	5902062092304

Paca z gąbką miękką

Float with soft sponge / Reibebrett mit Schramm weich / Терка с мягкой губкой / Тертка з м'якою губкою / Műanyag simító / Driščă cu burete moale / Hladítko s měkkou houbou / Hladidlo so špongiou jemné / Gladilka z mehko gobo / Trintuvé su minkšta kempine / Rive ar mīksto súkli / Pehme käsnağa kellu / Маламашка с мекка гъба / Plovak s mekom spružvom / Glačalica sa mekim sunderom / Σπάτουλα φινιρίματος με μαλακό απόγγο / Llana con esponja dura / Frattazzo / Desempenadeira com esponja mole / Taloché à éponge molle / Plaksraan met zachte spons

TOPEX



Ref.	L [mm]	W [mm]	info	☒	EAN
13A334	260	130	gąbka miękka	0/20	5902062092175

Paca z gąbką twardą

Float with hard sponge / Reibebrett mit Schramm hart / Терка с твердой губкой / Тертка з жорсткою губкою / Műanyag simító / Driščă cu burete dur / Hladítko s tvrdou houbou / Hladidlo so špongiou tvrdé / Gladilka s trdo gobo / Trintuvé su kieta kempine / Rive ar cietu súkli / Kõva käsnağa kellu / Маламашка с твърда гъба / Plovak s tvrdot spružvom / Glačalica sa tvrdim sunderom / Σπάτουλα φινιρίματος με σκληρό απόγγο / Llana con esponja blanda / Frattazzo / Desempenadeira com esponja dura / Taloché à éponge dure / Plaksraan met harde spons

TOPEX



Ref.	L [mm]	W [mm]	info	☒	EAN
13A332	260	130	gąbka twarda	0/20	5902062092188

Paca z gumą

Float with rubber / Reibebrett mit Gummi / Терка с резиновым покрытием / Тертка з гумою / Gumis simító / Drščá cu cauciuc / Hladitko s pryží / Hladidlo s gumou / Gladilka z guma / Gumuota trintuvė / Rive ar gumiju / Kummiga kellu / Гумена маламашка / Plovak s gumot / Glačalica s gumot / Σπάτουλα φινιρίσματος με λάστιχο / Llana con goma / Frattazzo / Desempenadeira com borracha / Taloche à caoutchouc / Plakspaan met rubber

NEO
TOOLS



Ref.	L [mm]	W [mm]	float [mm]	☒	EAN
50-232	280	140	4	0/10	5907558438796
50-231	280	140	8	0/10	5907558438628

TOPEX



Ref.	L [mm]	W [mm]	grubość [mm]	info	☒	EAN
13A320	260	130	8	guma 0/14		5902062090539
13A321	260	130	4	guma 0/30		5902062208323

Paca z filcem

Float with felt / Reibebrett mit Filz / Терка с войлочным покрытием / Тертка з поєстю / Múanyag simító / Drščá cu páslá / Hladitko s filcom / Hladidlo s filcom / Gladilka s filcom / Trintuvė su dirbtiniu veltniu / Rive ar tūbu / Fliisiga kellu / маламашка с филци / Plovak s filcom / Glačalica sa filcom / Σπάτουλα φινιρίσματος με κετσέ / Taloche con feltro / Frattazzo / Desempenadeira com feltro / Taloche à feutre / Plakspaan met vilt

NEO
TOOLS



Ref.	L [mm]	W [mm]	float [mm]	☒	EAN
50-242	280	140	4	0/10	5907558438871
50-241	280	140	8	0/10	5907558438857

Filc do pacy

Masonry felt / Filz für Reibebrett / Накладка войлочная для терки / Поєсть до тертки / Filc simítóhoz / Páslá de drščá / Plst' pro hladitko / Filc do hladidla / Filc za gladilko / Dirbtinis veltnis trintuvei / Sūkļa tūba / Fliis kellule / Φιλτζι за маламашка / Filc za plovak / Filc za rad / Στρώμα κετσέ για σπάτουλα φινιρίσματος / Feltro para llana / Feltro per frattazzo / Feltro para desempenadeira / Feutre pour taloche / Vilt voor troffel

NEO
TOOLS



Ref.	L [mm]	W [mm]	float [mm]	☒	EAN
50-261	280	140	4	0/100	5907558438901
50-262	280	140	8	0/50	5907558438918

Zestaw glazurniczy

Glazing kit / Set zum Fliesenverlegen / Набор плиточника / Набор до укладання нахлів / Burkoló készlet / Garnitură de glazurare / Sada na obklady / Glazúrovacia súprava / Komplet za pečarje / Rinkinys plytelių klįjavimui / Fližu licēja komplekts / Plaatimiskomplekt / Комплект за гледжосване / Set za glazuru / Pribor za glaziranje / Σετ για τοποθέτηση πλακιδίων / Juego para colocar azulejos / Set piastrellista / Kit gp. Azulejos / Jeu d'outils de carrelage / Glazuurset

NEO
TOOLS



25 l

Ref.	☒	EAN
50-253	0/1	5907558438741

TOPEX



Ref.	☒	EAN
13A339	0/1	5902062092335

Gąbka porowata

Porous sponge / Schwamm, porös / Губка пористая мягкая / Губка пориста / Szivacsokcska / Burete poros / Pórovitá houba / Pórovitá špongia / Goba s porami / Korèta kempinè / Porainais súklis / Poorne kâsn / Порестта гъба / Spružva s porama / Σφουγγικαν sunder / Σπόγγος μαλακός πορώδης / Esponja con poros / Spugna soffice / Esponja com poros / Mousse poreuse / Poreus spons

NEO
TOOLS

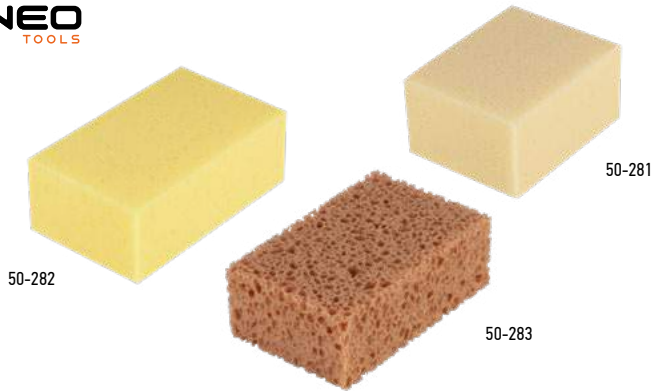

Ref.	L [mm]	W [mm]	H [mm]	info	☒	EAN
50-281	140	110	70	absorptive	0/100	5907558438819
50-282	165	100	60	soft	0/100	5907558438772
50-283	170	110	60	hard	0/100	5907558438970

TOPEX



Ref.	L [mm]	W [mm]	H [mm]	info	☒	EAN
13A343	140	110	70	porowa miękka	0/40	5902062208286
13A344	140	110	70	hydro-chłonna	0/40	5902062208293

Czerpak murarski

Masonry scoop / Mörtelöffel / Штукатурный ковш / Черпак мулярський / Κότινες serpenti / Cancioc / Zednická naběračka / Murárska naberačka / Zidarska zajemalka / Mürininko kaušas / Mürnieka kauss / Mürsepackul / Зидарско нанче / Zidarska fangla / Zidarsko vedro / Δοχείο κονιάματος με χειρολαβή / Recogedor para mortero / Vaschetta per muratore / Concha de pedreiro / Louche de maçon / Metselschep

NEO
TOOLS



Ref.	ø [mm]	☒	EAN
50-252	170	0/50	5907558438642

TOPEX



Ref.	ø [mm]	☒	EAN
13A890	160	0/50	5902062092502

Szpachla

Scraper / Spachtel / Шпатель / Шерхебел / Festékkaparó / Rázítóare / Špachtle / Špachtla universálna / Strgola / Glaistryklé / Špaktelis / Kaabits / Шпакля / Višenamjenska lopatica za kit / Spachtla / Σπάτουλα οδοντωτή / Espátula universal / Spatola / Betumadeira / Spatule / Plamuurmes

NEO
TOOLS

EXTREME



Ref.	W [mm]	☒	EAN
50-500	250	0/4	5907558453416
50-501	400	0/4	5907558453423
50-502	600	0/4	5907558453430
50-503	800	0/2	5907558453447
50-504	1000	0/2	5907558453454

Ostrze wymienne do szpachli

Replaceable blade for scraper extreme / Сменный нож для скребка / Змінне лезо для скребка екстремального / Cserélhető penge az kaparóhoz / Spatulă inlocuibilă pentru racleta extreme / Výměnitelné ostří / Ostrie výmenné lichobežníkové / Nadomestno rezilo / Keičiamos geležtės / Naža asmeņi / Noaterad / Nozici za skalpel / Ανταλλακτικές λεπίδες / Hojas de repuesto para cüter / Lame di ricambio / Lâminas substituíveis / Lames de remplacement / Vervangmesbladen

NEO
TOOLS

EXTREME



Ref.	for	W [mm]	☒	EAN
50-550	50-500	250	0/5	5907558453461
50-551	50-501	400	0/5	5907558453478
50-552	50-502	600	0/5	5907558453485
50-553	50-503	800	0/5	5907558453492
50-554	50-504	1000	0/5	5907558453508

Uchwyt do szpachli EXTREME

Holder scraper EXTREME / Держатель скребка EXTREME / Τримσχ скребка EXTREME / Tartó kaparó EXTREME / Rázítóar de suport EXTREME / Držák / Držiak / Zanka / Kļpa plaktukui / Josta āturam / Haamriaas / Натф / Držáč / Torbica za alat / Θήκη σφουγγιού / Portamartillo / Manico / Suporte / Manche / Houder

NEO
TOOLS

EXTREME

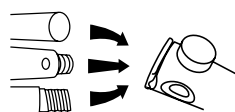

Ref.	for	☒	EAN
50-530	50-500	0/4	5907558453515

Szpachla do sztablatury

Scraper / Gipsedelputzspachtel / Шпатель для венецианской штукатурки / Шерхебель / Felületsimító / Rázátoare / Špachtle na benátskou omítku / Špachtla štúkatérska nerez / Strgalo / Glastyklé / Špaktelis apmetumam / Kaabits / Шпакля / Fasadna Lopatica za kit / Strugas / Ξύστρα / Espátula para acabado de yeso / Spatola per finiture in gesso / Betumadeira / Spatule pour enduit de qualité / Plamuurmes voor pleisterwerk

NEO
TOOLS



STAINLESS
steel

Ref.	W [mm]	☒	EAN
50-304	350	0/25	5907558438727
50-305	450	0/25	5907558438680
50-306	600	0/20	5907558438758

TOPEX



STAINLESS
STEEL

Ref.	W [mm]	☒	EAN
13A520	200	0/10	5902062091772
13A525	250	0/10	5902062091789
13A530	350	10/10	5902062091314
13A545	450	10/30	5902062091321
13A560	600	0/10	5902062091574

Szpachla malarska

Scraper / Malerspachtel / Шпатель малярный / Шерхебель / Festékkaparó / Rázátoare / Malířská špachtle / Špachtla maliarska / Strgalo / Glastyklé / Špaktelis / Kaabits / Шпакля / Lopatica za kit / Spahtla / Σπάτουλα οδοντωτή / Espátula de pintor / Spatola da muro / Betumadeira p. Pintura / Spatule de peinture / Plamuurmes voor verfwerk

NEO
TOOLS



STAINLESS
steel

Ref.	W [mm]	☒	EAN
50-351	20	12/120	5902062062642
50-352	40	12/120	5902062062659
50-353	50	12/120	5902062062666
50-354	63	12/120	5902062062673
50-355	75	12/120	5902062062680
50-356	100	12/120	5902062062697
50-357	125	12/120	5902062062703
50-358	150	12/120	5902062062710
50-359	200	12/120	5902062062727
50-360	250	12/120	5902062062734

TOPEX



STAINLESS
STEEL

Ref.	W [mm]	☒	EAN
18B604	40	12/120	5902062186041
18B605	50	12/120	5902062186058
18B606	63	12/120	5902062186065
18B607	75	12/120	5902062186072
18B610	100	12/120	5902062186102
18B612	125	12/120	5902062186126

TOPEX



Ref.	W [mm]	☒	EAN
18B218	61	12/240	5902062120885

TOPEX



Ref.	W [mm]	☒	EAN
18B204	40	12/240	5902062120731
18B206	60	12/240	5902062120748
18B208	80	12/240	5902062120687
18B210	100	12/144	5902062120694
18B212	125	12/144	5902062120984
18B215	150	12/144	5902062120717

TOP TOOLS



Ref.	W [mm]	☒	EAN
18B303	30	12/240	5902062120014
18B304	40	12/240	5902062120021
18B305	50	12/240	5902062120038
18B306	60	12/240	5902062120045
18B308	80	12/240	5902062120052
18B310	100	12/240	5902062120069
18B312	125	12/144	5902062120403

TOP TOOLS

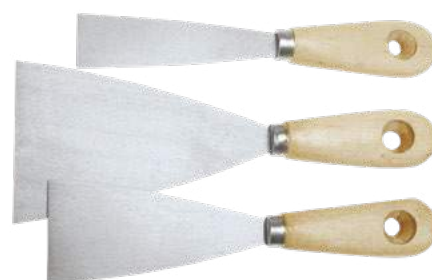

Ref.	W [mm]	N	☒	EAN
18B330	30 - 80	×3	12/72	5902062090669

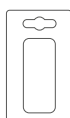

Szpachle malarskie

Scraper set / Malerspachteln / Шпатели малярные / Шерхебелі, набір / Gletteló készlet / Rázátoare set / Malířské špachtle / Špachtle maliarske set / Garnitura strgal / Glaistyklys / Špakteļu komplekts / Kaabitsakomplekt / Шпакли / Špachtla set / Συλλογή από σπάτουλες οδοντωτές / Espátula de pintor / Spatole giarponesi / Betumadeiras p. Pintura / Spatules de peinture / Verf-plamuurmessen

TOPEX



x4

STAINLESS
STEEL

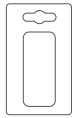

Ref.	W [mm]	☒	EAN
18B436	50, 80, 100, 120	10/100	5902062121790

Szpachelki do silikonu

Silicone spatula / Silikonspachtel / Шпатели для силикона / Шпатель по силикону / Szilikon glettvás / Spatulă pentru silicon / Špachtle na silikon / Silikónové špachtle / Lopatica za silikon / Mentelės silikonui / Silikona špaktele / Silikonispaattid / Шпакли за силикон / Špachtle za silikon / Lopatice za silikon / Σπάτουλες για σιλικόνη / Espátulas para silicona / Spatole per silicone / Espátulas para silicone / Spatules en silicone / Spatel voor silicoon

TOPEX



x4

TPR

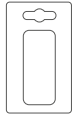

Ref.	☒	EAN
16B472	0/100	5902062057334

Zdzierak

Scraper / Vorfeile / Рубанок / Шерхебелъ / Ráspoly / Čuť de razuit / Rašpljovj hoblík / Rašpla / Strgalo / Dildé / Évele / Raspel / Нож за груба обработка / Odbojnik / Rende / Πλάνη / Escofina / Spatola / Lima grossa / Råpe / Krabber

TOPEX

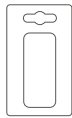

Ref.	L [mm]	☒	EAN
11A406	140	6/60	5902062031914
11A411	250	10/40	5902062031938

Ostrze do zdzieraka

Scraper blade / Schrupphobelklinge / Лезвие для рубанка-рашпеля / Лезо до шерхебеля / Ráspolybetét / Lamã racletă / Ostří do uběráku / Plátok náhradný / Rezilo za strgalo / Grandklio geležtë / Asmenis skrāpim / Kaabitsa leht / Ρενδε / Ulošci za strugač / Ulošci za stugač / Λεπίδα για ζίστρα / Hoja para escofina / Lama per pialla / Lâmina p. lima grossa / Tranchant de râpe / Krabberblad

TOPEX



SK2

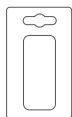

Ref.	L [mm]	uwagi	☒	EAN
11A409	140	do 11A406	20/200	5902062031921
11A413	250	do 11A411	20/80	5902062031945

TOP TOOLS



x4

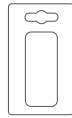

Ref.	W [mm]	N	☒	EAN
18B437	50, 80, 100, 120	x4	0/240	5902062121806

Zdzierak do styropianu

Scraper for polypropylene board / Vorfeile für geschäumtes Polystyrol / Рубанок / Тертка до пінопласту / Polisztírol csiszoló / Gletiera pentru razuit / Hoblík na polystyrén / Rašpla na polystyrén / Strgalo za stiropor / Trintuvé puty polistírolui / Évele / Vahtpolüsterooliraspel / Нож за груба обработка на стиреопор / Odbojnik za stiropor / Rende za stiropor / Πλάνη / Escofina para poliestireno / spatola per tavola in polipropilene / Lima grossa para poliestireno extruído / Råpe pour polystyrène / Krabber voor polystyreen

NEO TOOLS



Ergonomic
beechen
handle

Ref.	L [mm]	W [mm]	☒	EAN
50-251	270	130	0/20	5907558438604

TOPEX



Ref.	L [mm]	W [mm]	☒	EAN
13A360	270	130	0/15	5902062091710

Blok ścierny

Sanding block / Schleifblock / Блок шпифовальний / Блок шпифувальний / Csiszolótuskó / șlefuitoare de abezi / Brusný blok / Držák brúsneho papiera / Brusni papir / Šljfavnimo skriemulys / Smilšpapira turētājs / Lihvimisklote / Шпаїлер / Držáč brusnog papira / Brusni papir u rolni / Τάκος λείανσης / Bloque abrasivo / Tampone per levigare / Redes abrasivas / Grilles abrasives / Schuurblok

TOPEX



Ref.	L [mm]	W [mm]	☒	EAN
08A108	165	85	1/100	5902062206923
08A110	210	100	30/60	5902062206930

Plótna ściernie

Abrasive cloths / Schleiflein / Шлифовальные полотна / Полотна наждакови / Csiszolóvászon / Pánze abrazive / Brusná plátina / Brúsné plátina / Brusna platna / Šíjavnito papieriai / Šlīpēšanas audekls / Lihvrie / Αβρασιβни платна / Brusna platna / Abrazivna platna / Χαρτιά λείανσης / Lijas de tela / Tela abrasiva / Tecidos abrasivos / Toiles abrasives / Schuurtextielen

TOPEX



x10

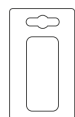

Ref.	L x W [mm]	K	☒	EAN
08A422	230 x 280	40	0/34	5902062211019
08A424	230 x 280	60	1/34	5902062211026
08A426	230 x 280	80	0/45	5902062211033
08A428	230 x 280	100	0/45	5902062211040
08A430	230 x 280	120	15/45	5902062211057
08A434	230 x 280	220	1/68	5902062211071

Wiadro

Bucket / Eimer / Ведро / Відро / Festövödör / Căldare / Kbelík / Vedro stavbárske / Vedro / Kibiras / Spainis / Ämber / Κοψα / Kanta / Kofa za malter / Κάδος / Cubo de obra / Mastello / Balde / Seau / Emmer

TOPEX



Ref.	V max [l]	☒	EAN
13A700	10	0/1	5902062091550

Wiadro budowlane

Bucket / Eimer für Bauzwecke / Ведро растворное / Відро будівельне / Habarcsvödör / Galeata pentru mortar/construcții / Stavební kbelík / Stavební vedierko / Zidarsko vedro / Kibiras / Būvniecības spainis / Ehitusämber / Κοψα за приготвяне на разтвор / Zidarsko vjedro / Građevinska kofa / Κοψάς κομμάτος / Cubo de obra / Secchio / Balde industrial / Seau de chantier / Bouwemmer

TOPEX



Ref.	V max [l]	☒	EAN
13A703	12	0/1	5902062091567

Kastra budowlana

Mortar container / Mörtelkasten / Емкость растворная / Корито будівельне / Habarcsláda / Contaner p/u ceatur de construcție / Korba na maltu / Nádoba na maltu / Zidarska kanta / Statybinių karučiai / Celtniecības toveris / Mōrdinīu / Леген строителен / Mortaljka / Gipsarski kontejner / Σάφρη οικοδομής / Cubo para mortero / Contenitore per malta / Tanque para construção / Auge de construction / Mortelbak

TOPEX



Ref.	V max [l]	☒	EAN
13A760	65	0/1	5902062091185
13A780	90	0/1	5902062091192

Siatki ściernie

Abrasive grids / Schleifgitter / Шлифовальная сетка / Сітки наждакови / Csiszolórács / Plase abrazive / Brusné sítky / Brúsná mriežka / Brusne mreže / Šíjavnito tinkleliai / Šlīpēšanas tīklī / Lihnvörk / Αβρασιβни мрежи / Brusne mreže / Abrazivne mreže / Πλέγμα λείανσης / Mallas de lijado / Carta abrasiva / Redes abrasivas / Grilles abrasives / Schuurmetten

TOPEX

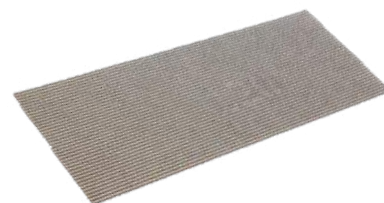

Ref.	L x W [mm]	K	N	☒	EAN
08A606	280 x 110	60	x5	0/420	5902062211491
08A608	280 x 110	80	x5	0/200	5902062211507
08A610	280 x 110	100	x5	0/500	5902062211514
08A612	280 x 110	120	x5	0/520	5902062211521
08A615	280 x 110	150	x5	0/560	5902062211538



TOPEX



Ref.	V max [l]	☒	EAN
13A712	12	0/1	5902062091161
13A720	20	0/1	5902062091178

TOPEX



Ref.	V max [l]	☒	EAN
13A716	16	0/1	5902062092427

Sznurek murarski

Masonry line / Maurerschnur / Шнур разметочный каменщика / Шнур мулярський / Kőműveszsinór / Linie zidire / Zednický provázek / Šnúrka murárska / Zidarska vrv / Virvelé mürininkui / Mürnieka aukla / Müürinöör / Канан зидарски / Zidarski konac / Zidarski kanap / Σκοινί οικοδόμου / Cuerda de albañil / Filo per muratore / Corda p. Alvenaria / Fil de maçons / Metselsnoer

NEO
TOOLS



ø1.5
mm

Ref.	L [m]	☒	EAN
49-905	50	32/128	5907558440072
49-910	100	16/64	5907558440058

NEO
TOOLS



ø0.9
mm

Ref.	L [m]	☒	EAN
49-920	100	25/100	5907558440065

TOPEX



Ref.	L [m]	☒	EAN
13A905	50	32/128	5902062091888
13A910	100	16/64	5902062091895

TOPEX



Ref.	L [m]	☒	EAN
13A920	100	25/100	5902062092434

Sznurek

Rope / Schnur / Шнурок / Шнур / Spárga / Snur / Provázek / Šnúrka / Vrv / Raištelis / Auklija / Nöör / Въжец / Копорак / Копорак, узика / Κορδόνι / Cuerda / Spago / Corda / Fil

NEO
TOOLS



1000
mb **PP**
40
daN 15cm
1000
TEX
+/- 3%

Ref.	L [m]	☒	EAN
49-931	1000	0/6	5907558465402

NEO
TOOLS



Ref.	L [m]	Ø [mm]	☒	EAN
49-915	100	1	20/240	5907558440089

Kreda tehniczna

Marking chalk / Kreide für technische Zwecke / Мел технический / Крейда технична / Jelölőkréta fehér / Credă tehnică / Technická křída / Technická kreda / Industrijska kreda / Pramoninė kreida / Tehniskais krīts / Tehniline kriit / Технически тебешур / Tehnička kreda / Tehnička kreda / Κυμωλία τεχνική / Tiza técnica / Gesso da imbianchino / Giz técnica / Craie industrielle / Markeerkrijt

NEO
TOOLS

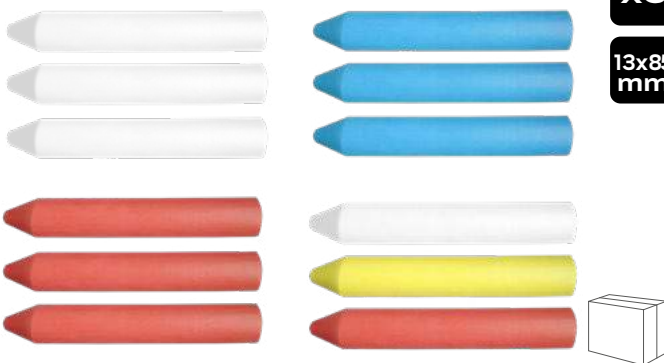

x3

13x85
mm

Ref.	☒	EAN
13-950		5907558443936
13-954		5907558443943
13-956		5907558443950
13-968		5907558443967

TOPEX



Ref.	L [m]	Ø [mm]	☒	EAN
13A915	100	1	0/240	5902062091901

Kreda tehniczna

Marking chalk / Kreide für technische Zwecke / Мел технический / Крейда технична / Jelölőkréta fehér / Credă tehnică / Technická křída / Technická kreda / Industrijska kreda / Pramoninė kreida / Tehniskais krīts / Tehniline kriit / Технически тебешур / Tehnička kreda / Tehnička kreda / Κυμωλία τεχνική / Tiza técnica / Gesso da imbianchino / Giz técnica / Craie industrielle / Markeerkrijt

NEO
TOOLS



x12

120x12
mm

Ref.	☒	EAN
13-961	colour	5907558440072
13-962		5907558440058
13-963		5902062063526

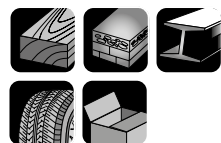

Kreda techniczna

Marking chalk / Kreide für technische Zwecke / Мел технический / Крейда технична / Jelölőkreda fehér / Credă tehnică / Technická křída / Technická kreda / Industrijska kreda / Pramonine kreda / Tehniskais krīts / Tehniline kriit / Технически тебешур / Tehnička kreda / Κυμωλία τεχνική / Tiza técnica / Gesso da imbianchino / Giz técnica / Craie industrielle / Markeerkrijt

T TOPEX

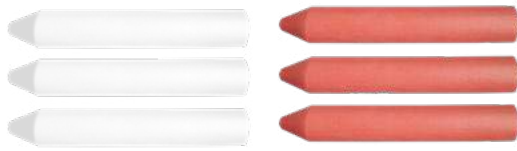

Ref.		☒	EAN
14A950		0/240	5902062002655
14A956		0/240	5902062002679

T TOPEX

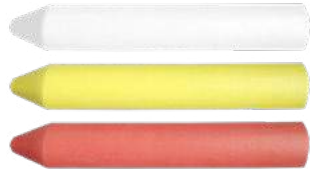

Ref.	☒	EAN
14A968	0/240	5902062002686



T TOPEX

HB



Ref.	L [mm]	☒	EAN
14A800	240	72/1440	5902062121707

Ołówek murarski

Masonry pencil / Maurerstift / Карандаш наменщина / Олівець мулярський / Ácscezuza / Creion piatră / Zednická tužka / Ceruzka murárska / Zidarski svinčnik / Mürininko pieštukas / Žimulis mūmieka / Mürseparpliats / Молюс / Olovka za majstore / Olovka za majstore / Μολύβι λιθοδόμου / Lápiz de albañil / Matita da carpentiere / Lápiz p. Alvenaria / Crayon de maçons / Metselaarspotlood

NEO TOOLS

4H



Ref.	L [m]	☒	EAN
13-801	240	72/1440	5907558443981

Ołówek do szkła

Pencil for glass / Glasstift / Карандаш по стеклу / Олівець по склу / Ácscezuza / Creion sticlă / Tužka na sklo / Ceruzka sklenárska / Svinčnik za steklo / Pieštukas stiklui / Žimulis stiklam / Klaasipliats / Молюс за стъкло / Olovka za staklo / Olovka za staklo / Μολύβι γυαλογράφου / Lápiz para vidrio / Matita per vetro / Lápiz para vidro / Crayon à verre / Glaspotlood

NEO TOOLS

R



Ref.	L [mm]	☒	EAN
13-802	240	72/1440	5907558443998

Kreda do trasowania

Chalk / Trassierkreide / Мел трассировочный / Крейда трасувальна / Porfesték / Cretă / Křída / Farba / Kreda / Kreda žymejimai / Krīts krīta līnijai / Kriit / Креда за чертилна / Prah za crtanje / Prah za obeležavanje / Κυμωλία για χάραξη / Polvo de trazado / Polvere tracciante / Giz p. traçar / Craie à tracer / Krijt

T TOPEX



Ref.	m [g]	kolor	☒	EAN
30C616	115		10/100	5902062111869
30C617	115		10/100	5902062111876

Ołówek stolarski

Carpenter's pencil / Tischlerstift / Карандаш столярный / Олівець столярний / Ácscezuza / Creion lăcătuș montor / Tesářská tužka / Ceruzka stolárska / Tesarski svinčnik / Stalious pieštukas / Žimulis galdnieka / Puuseparpliats / Молюс / Olovka za majstore / Olovka za majstore / Μολύβι ξυλοργού / Lápiz de carpintero / Matita da carpentiere / Lápiz p. Madeira / Crayon de menuisier / Timmermanspotlood

NEO TOOLS

HB



Ref.	L [m]	☒	EAN
13-800	240	72/1440	5907558443974

TOP TOOLS



Ref.	N	☒	EAN
14A810	×1	144/1440	5902062104649
14A803	×3	100/300	5902062120861
14A812	×12	24/240	5902062121127
14A872	×72	5/40	5902062203014

T TOPEX

4H



Ref.	L [mm]	☒	EAN
14A801	240	72/1440	5902062121714

Ołówek techniczny czerwono-niebieski

Carpenter's pencil red and blue / Technischer Bleistift / Технический карандаш красно-синий / Технічний олівець червоно-синій / Műszaki ceruza piros és kék / Set 12 creioane cu cap dublu, 2 culori / Tužka / Ceruzka / Svinčnik / Pieštukas / Žimulis / Pliats / Молюв / Olovka / Olovka / Молюби / Lápiz / Matita / Lápiz / Crayon / Potlood

NEO
TOOLS



Ref.	L [m]	☒	EAN
13-805	240	0/120	5907558443998

TOP TOOLS



Ref.	☒	EAN
14A892	144/1440	5902062121035

Ołówek stolarski / murarski automatyczny

Masonry Carpenters Automatic Pencil / Masonry Carpenters Automatic Pencil / Автоматический карандаш мащенница / Автоматичний олівець муляра / Automatikus ácsceruza / Creion mecanic de timplarie / Tužka / Ceruzka / Svinčni / Pieštukas / Žimulis / Pliats / Молюв / Olovka / Olovka / Молюби / Lápiz / Matita / Lápiz / Crayon / Potlood

NEO
TOOLS

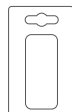

Ref.	☒	EAN
13-810	25/250	5902062063441

NEO
TOOLS

x6
graphites

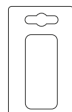

Ref.	☒	EAN
13-815	20/100	5902062063458

Grafit

Graphite / Графитум / Grafit / Grafit / Tuha / Grafit / Grafitas / Grafitas / Grafit / Графитум / Grafit / Grafit / Γραφίτης / Engrase / Grafite / Grafite / Graphite / Grafiet

NEO
TOOLS



x5

Ref.	☒	EAN
13-820	100/1000	5902062063465
13-821	100/1000	5902062063472
13-822	100/1000	5902062063489

Temperówka do ołówek technicznych

Carpenters pencil sharpener / Точилка для технических карандашей / Точилка для технічних олівців / Ácsironhegyező / Ascuțitor pentru creioane de tâmplărie

NEO
TOOLS



Ref.	☒	EAN
13-830	40/400	5902062063496

Marker permanentny

Permanent marker / Permanentmarker / Перманентный маркер / Перманентний маркер / Jelölőfilc mini / Marker permanent / Permanentní popisovač / Permanentný popisovač / Permanentni marker / Permanentinis markeris / Permanents markieris / Permanentmarker / Постоянен маркер / Permanentni marker / Trajni marker / Ανεξίτηλος μαρκαδόρος / Marcador permanente / Marker permanente mini

TOPEX



x80

Ref.	☒	EAN
14A895	80/1280	5902062008718

Szczotka druciana

Wire brush / Drahtbürste / Щетка проволочная / Щітка по металу / Spidkefe / Perie metal / Drátěný kartáč / Keľa drôtená univerzálna / Žična krtača / Vielinis šepetyš / Dräšu birste / Traathari / Четка мелена / Četka sa PVC drškom / Συρμάτινη βούρτσα / Cepillo de alambre / Spazzola metallica / Escova de arame / Brosse métallique / Draadborstel

NEO
TOOLS

STEEL



39-012



39-010

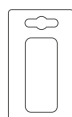

Ref.	rows	☒	EAN
39-010	4x16	10/100	5907558452624
39-012	3x19	12/36	5907558452693

Szczotka druciana

Wire brush / Drahtbürste / Щетка проволочная / Щітка по металу / Spidkefe / Perie metal / Drátěný kartáč / Keľa drôtená univerzálna / Žična krtača / Vielinis šepetyš / Dräšu birste / Traathari / Четка мелена / Četka sa PVC drškom / Συρμάτινη βούρτσα / Cepillo de alambre / Spazzola metallica / Escova de arame / Brosse métallique / Draadborstel

NEO
TOOLS

NYLON

NEO
TOOLS

BRASS



39-032



39-030

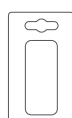

Ref.	rows	☒	EAN
39-030	4x16	10/100	5907558452631
39-032	3x19	12/36	5907558452709
39-031	5x11	12/72	5907558452662

Ref.	rows	☒	EAN
39-011	5x11	12/72	5907558452655

Szczotka druciana

Wire brush / Drahtbürste / Щетка проволочная / Щетка по металу / Spidkefe / Perie metal / Drátěný kartáč / Keňa drátěná univerzálna / Žična krtača / Vielinis šepetys / Drašu birste / Traathari / Четка мелена / Četka sa PVC drškom / Četka / Συμπλήθη Βούρτσας / Cepillo de alambre / Spazzola metallica / Escova de arame / Brosse métallique / Draadborstel

NEO
TOOLS

STAINLESS
STEEL



39-052

39-050

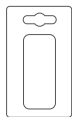

Ref.	rows	☒	EAN
39-050	4x16	10/100	5907558452648
39-052	3x19	12/36	5907558452716
39-051	5x11	12/72	5907558452679

NEO
TOOLS



x3

STEEL

NYLON

BRASS

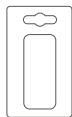

Ref.	rows	☒	EAN
39-100	3x7	12/120	5907558452686

TOPEX



Ref.	L [mm]	☒	EAN
14A523	240	12/120	5902062120960

TOPEX



Ref.	rows	☒	EAN
14A614	4	12/120	5902062121677
14A615	5	12/120	5902062121684
14A616	6	12/120	5902062121691

TOP TOOLS



Ref.	rows	☒	EAN
14A604	4	12/72	5902062120083
14A605	5	12/72	5902062120090
14A606	6	12/72	5902062120106

TOP TOOLS

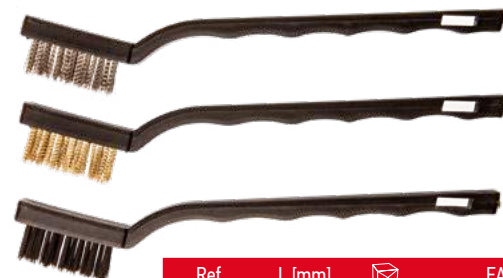

x3

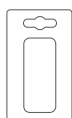

Ref.	L [mm]	☒	EAN
14A618	180	12/144	5902062202482
14A623	230	12/72	5902062202819

Wycinaki do otworów

Hole punch set / Lochausschneidemaschine / Пробойники круглых отверстий / Кернер, набор / Börtlyukasztó készlet / Set perforare găuri / Выкрајовачка до отворů / Súprava vysekávačov / Garnitura prebijalcev / Pjoviklari ertmėms / Saurumsitēju komplekts / Augstajsta komplekts / Замби компл. / Probijači set / Zumbe set / Συρόμηνες / Sacabocados / Pinzoni per forare / Matriz de recortar / Bédanes à ouvertures / Gatenskippers

TOPEX



x9



Ref.	Ø [mm]	☒	EAN
03A490	3 - 12	0/20	5902062031761

Strug

Plane / Hobel / Рубанок / Рубанок / Gyalu / Rindea / Hoblík / Hoblík / Oblič / Oblus / Évele / Hőövel / Ренде / Blanja / Strug / Πλάνη / Cepillo / Pialla / Garlopa / Rabot / Schaafmachine

TOPEX



Ref.	L [mm]	W [mm]	W noža [mm]	☒	EAN
11A230	240	30	30	0/20	5902062100115

Strug

Plane / Hobel / Рубанок / Рубанок / Gyalu / Rindea / Hoblík / Hoblík / Oblič / Oblus / Évele / Hőövel / Ренде / Blanja / Strug / Πλάνη / Cepillo / Pialla / Garlopa / Rabot / Schaafmachine

TOPEX



Ref.	L [mm]	W [mm]	W noža [mm]	☒	EAN
11A314	200	55	40	0/25	5902062030894

TOP TOOLS



Ref.	L [mm]	W [mm]	☒	EAN
11A145	235	45	0/24	5902062100764

Nóż do szkła

Glass cutter / Glasmesser / Стеклорез / Склопія / Üvegvágó / Čužit sticla / Nůž na sklo / Rezač na sklo / Nož za steklo / Peilis stiklivi / Stiklgriezis / Klaasilõikur / Επμας Τοπεξ / Nožić za staklo / Nožic za staklo / Κοπικό εργαλείο γυαλιού / Cuchillo cortador de vidrio / Coltello per vetro / Faca para vidro / Couteau à verre / Glasmes

NEO
TOOLS

LIFETIME
5000m

WOODEN
HANDLE

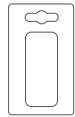

Ref.	⊠	EAN
56-820	0/240	5907558461688

NEO
TOOLS

LIFETIME
15000m

TUNGSTEN
CARBIDE
CUTTING
WHEEL

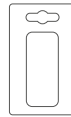

Ref.	⊠	EAN
56-821	0/240	5907558461671

Bohle



Ref.	model	⊠	EAN
320.0	Jobo	12/1200	5902062200037
100.0	Silberschnitt	12/600	4010122100003

TOPEX

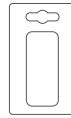

Ref.	⊠	EAN
14A710	12/48	5902062501004

Przysawka

Vacuum cup / Saugnäpfchen / Присоска / Присоска / Ταρδόκορον / Dispozitiv de aspiratie / Přisavka / Prísavka / Prisesek / Siurbtukas / Piesūceknis / Iminapp / Вентуза / Vakuum kapa / Sisaljka / Βεντούζα / Ventosa / Ventosa / Copo de sucção / Ventouse / Zuighouder

NEO
TOOLS

max
160
kg

200
mm

glaze
glass

plastic
marble

coated
wood
lacquered
metal



Ref.	Fmax [kg]	⊠	EAN
56-800	160	0/10	5907558454246

NEO
TOOLS

AL
max
50
kg

120
mm

glaze
glass



Ref.	Fmax [kg]	⊠	EAN
56-801	50	0/48	5907558461640

NEO
TOOLS

AL
max
100
kg

glaze
glass



Ref.	Fmax [kg]	⊠	EAN
56-802	100	0/24	5907558461657

NEO
TOOLS

AL
max
150
kg

glaze
glass



Ref.	Fmax [kg]	⊠	EAN
56-803	150	0/12	5907558461664

TOPEX



14A780



14A740

Ref.	Ø [mm]	Fmax [kg]	⊠	EAN
14A740	120	40	0/48	5902062147400
14A780	2 x 120	80	0/24	5902062147806



Kobytki

Trestle / Tischböcke / Козлы / Козелки / Munkaállvány / Capre / Skládací podstavce / Kozy / Delovni stojali / Keturkojës atramos / Steki / Pukid / Мазапара / Nogari / Kobilice / Καβαλέτο / Caballetes / Cavalletto / Escadotes de um grau / Tréteau / Schragen

TOPEX



x2

78
cm

227
kg

Ref.	⊠	EAN
79R187	0/4	5902062791870



Stół warsztatowy

Work bench / Werkstattbank / Стол-верстак / Вертмак / Munkapad / Teighea tîmplărie / Dilenský stůl / Stólik pracovný / Delavniška miza / Darbastalis / Darba galds / Tööpink / Работна маса / Stol radionički / Radni sto / Πάγκος εργασίας / Banco de trabajo / Tavolo da lavoro / Mesa de oficina / Etabli d'atelier / Werkplaatstafel

TOPEX



Ref.	W [mm]	L [mm]	H [mm]	☒	EAN
07A420	600	240	800	0/1	5902062160829

TOP TOOLS



Ref.	W [mm]	L [mm]	H [mm]	☒	EAN
07A415	640	560	780	0/1	5902062169471

Podpora teleskopowa

Quick support / Teleskopstütze / Опора телескопическая / Опора телескопична / Támasztó / Suport telescopic / Teleskopová podpora / Podpera teleskopická "tretia ruka" / Stega / Teleskopinė atrama / Stute teleskopiska / Teleskoop-tugi / Подпора телескоп. / Teleskopski nastavak / Teleskopski nastavak / Báán / Soporte telescópico / Supporto telescopico / Suporte telescópico / Support télescopique / Telescopische steun

TOPEX



Ref.	L [mm]	Fmax [kg]	☒	EAN
07A430	165 - 300	50	0/10	5902062941657
07A431	75 - 125	50	0/10	5902062941664

TOPEX



Ref.	L [mm]	Fmax [kg]	☒	EAN
07A432	115 - 290	35	0/6	5902062505620
07A433	50 - 105	20	0/8	5902062505637

Detektor

Detector / Detektor / Детектор / Демектор / Detector / Detector / Detektor / Detektor / Detektor / Ieșiklis / Detektors / Detektor / Демектор / Detektor / Detektor / Ανιχνευτής / Detector / Rilavatore tubi/cavi elettrici/metallo / Detetor / Détecteur / Detector

TOPEX

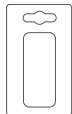

Ref.	☒	EAN
94W120	12/24	5902062941206

Pędzel płaski uniwersalny

Universal paintbrush / Allzweckpinsel / Кисть универсальная / Пензель универсальный / Ecset / Pensula universal / Univerzální štětec / Štetec univerzálný / Čopič univerzalni / Universalus šepetys / Universāla ota / Universaalpinsel / Универсална четка / Univerzalni kist / Univerzalna četkica / Πινέλο πολλαπλών χρήσεων / Brocha universal / Pennello universale / Pincel universal / Pinceau universel / Universeel kwast

TOPEX



Ref.	A	☒	EAN
19B610	1"	12/600	5902062196101
19B615	1,5"	12/420	5902062196156
19B620	2"	12/240	5902062196200
19B625	2,5"	12/240	5902062196255
19B630	3"	12/180	5902062196309
19B640	4"	12/144	5902062196408

Pędzel ławkowiec

Ceiling brush / Pinsel / Кисть-лапшовица / Пензель малярна / Mennyezet ecset / Pensulă de zugrav / Šižetka obdélník / Štetka obdĺžniková / Čopič / Dažymo šepetėlis / Ota / Lakipinsel / Баданарка / Kist plosnati / Molerska četkica / Πινέλο Βαφής / Brocha grande / Pennellessa / Pincel / Pinceau plat / Plafondkwast

TOPEX

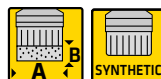

TOPEX

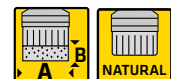

Ref.	A [mm]	B [mm]	☒	EAN
19B116	150	70	12/72	5902062191168
19B117	170	70	0/60	5902062191175
19B118	175	80	0/72	5902062191182

Ref.	A [mm]	B [mm]	☒	EAN
20B966	100	30	12/168	5902062005779
20B968	140	40	6/96	5902062005793
20B969	150	50	6/96	5902062005809

Zestaw pędzli

Paint brush set / Malerpinsel / Кисти малярные / Пензлі малярські, набір / Ecset készlet / Set perii vopsea / Malířské štětce / Štetec maliarsky set / Garnitura pleskarskih čopičev / Teptukai dažymui / Otu kompleks krāsošanai / Malpripintslite komplekt / Комплект четки / Set kistova / Cetka za krecenje / Πινέλα βαφής / Brochas de pintor / Pennelli da pittore / Pincéis para pintura / Pinceaux de peinture / Verfwksten

TOPEX

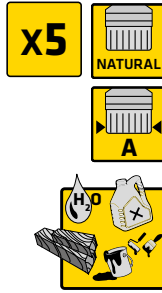

Ref.	A	☒	EAN
20B816	1"; 1.5"; 0; 2; 4	0/100	5902062006721

TOPEX

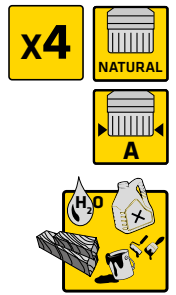

Ref.	A	☒	EAN
20B817	1"; 1.5"; 0; 4	0/100	5902062006738

Rolka emulsiyjna

Roll for emulsion paints / Rolle, Emulsionfarbe / Ролл для водоэмульсионных красок / Ролл до емульсійних фарб / Festöhenger / Trafalet de emulsie / Emulzní váleček / Valček na emulzné farby / Valj za emulzije / Volelis emulsijos dažams / Rullītis emulsijai / Emulsioinrulli kate / Эмульсионна ролка / Valjak za emulzijske boje / Valjak za emulziju / Ανταλλακτικός κύλινδρος ρολιού για πλαστικό χρώμα / Repuesto para rodillo para emulsión / Rullo per vernici ad emulsione / Rolo p. tintas de emulsão / Rouleau pour peinture émulsion / Roller voor emulsieverf

TOPEX

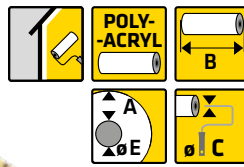

Ref.	A [mm]	B [mm]	C [mm]	E [mm]	☒	EAN
20B525	13	250	8	48	0/60	5902062006103
20B526	13	180	8	48	0/60	5902062006110

TOPEX

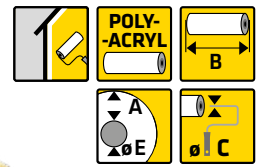

Ref.	A [mm]	B [mm]	C [mm]	E [mm]	☒	EAN
20B540	11	250	8	48	0/60	5902062006219
20B542	7	100	6	30	0/120	5902062006233

Rolka fasadowa

Roll for emulsion paints / Rolle, Fassadenfarbe / Ролл фасадный / Ролл до фасадиє / Festöhenger / Trafalet de fatada / Fasádní váleček / Valček na fasády / Valj za fasado / Volelis išorės dažymo darbam / Fasādes rullītis / Fassadairulli kate / Фасадна ролка / Valjak za fasadne boje / Valjak za fasadu / Ανταλλακτικός κύλινδρος ρολιού πρόσοψης / Repuesto para rodillo para fachadas / Rullo per vernici ad emulsione / Rolo p. fachadas / Rouleau façade / Gevelroller

TOPEX

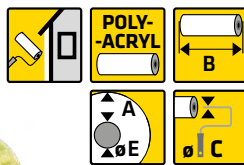

Ref.	A [mm]	B [mm]	C [mm]	E [mm]	☒	EAN
20B551	18	180	8	48	0/60	5902062006264

Rolka olejna

Roll for oil paints / Rolle, Ölfarbe Mini / Ролл для масляных красок мини / Ролл до олійних фарб міні / Festöhenger / Trafalet de ulei / Olejový váleček mini / Valček na olejové farby / Valj za oljne barve / Volelis aliejinjams dažams / Rullītis eļļai / Mini-šlirulli kate / Блажсна ролка / Valjak za uljane boje / Valjak za ulje / Ανταλλακτικός κύλινδρος μίνι ρολιού για λαδομπογιά / Repuesto para rodillo para pinturas al óleo / Rullo per vernici ad olio / Rolo p. tintas de óleo / Rouleau pour la peinture à l'huile / Roller voor olieverf

TOPEX

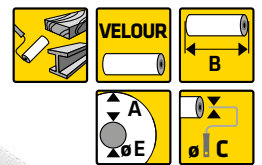

Ref.	A [mm]	B [mm]	C [mm]	E [mm]	☒	EAN
20B555	4	180	8	48	0/60	5902062006295
20B557	4	100	6	15	0/500	5902062006318

Wałek emulsiyjny

Roller for emulsion paints / Welle, Emulsionfarbe / Валик для водоэмульсионных красок / Валик до емульсійних фарб / Festöhenger / Trafalet de emulsie / Emulzní váleček / Valček na emulzné farby / Valj za emulzije / Volelis emulsijos dažams / Veltnītis emulsijai / Emulsioinrull / Эмульсионен валик / Valjak - kotač za emulzijske boje / Valjak za emulziju / Ρολλό για πλαστικό χρώμα / Rodillo para emulsión / Rullo con manico per vernici ad emulsione / Rolo p. tintas de emulsão / Rouleau pour peinture émulsion / Roller voor emulsieverf

TOPEX

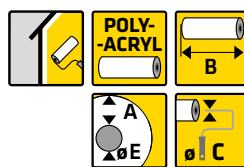

Ref.	A [mm]	B [mm]	C [mm]	E [mm]	☒	EAN
20B594	13	180	8	48	0/48	5902062005328

TOPEX

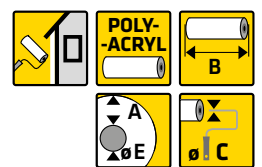

Ref.	A [mm]	B [mm]	C [mm]	E [mm]	☒	EAN
20B597	18	180	8	48	0/48	5902062005335

Walek olejny

Roller for oil paints / Welle, Öljarbe / Валик для масляных красок / Валик до олійних фарб / Festöhenger / Trafalet de ulei / Olejový váleček / Valček na olejové farby / Valj za oljne barve / volelis, aliejiniams dažams / Veltņitis eļļai / Ölirull / Блажен валик / Valjak - kotača uljne boje / Valjak za ulje / Ρολλό για λαδομπογιά / Rodillo para pinturas al óleo / Rullo con manica per vernici ad olio / Rolo p. tintas de óleo / Rouleau pour la peinture à l'huile / Roller voor olieverf

TOPEX

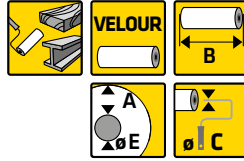

Ref.	A [mm]	B [mm]	C [mm]	E [mm]	☒	EAN
20B587	4	100	6	15	0/100	5902062006493

Kuweta malarska

Tray / Malerschale / Ванночка малярная / Кювета малярська / Festó tábla / Chiuvetá p/u zugravi / Kuweta malarska / Miska malarska / Pleskarska kadica / Lovelis dažams / Vannite krāsai / Värnivann / Корупто / Kadica / Kadica / Σκάφη βαφής / Bandeja de plástico para pintura / Vassoio / Vaso para pintura / Bac de peinture / Verfbak

TOPEX



Ref.	info	☒	EAN
20B667	32 x 26 cm	0/40	5902062005267

Zestaw do tapetowania

Wallpapering kit / Tapetenset / Комплект для поклейки обоев / Набор для наклеювання шпалер / Tapétázókészlet / Set tapet / Tapetovací sada / Tapetovacia sada / Kit de empapelado / Kit tappezzeria

TOPEX



x4

Ref.	☒	EAN
20B945	10/40	5902062508270

Kij teleskopowy

Telescopic pole / Teleskopstock / Штанга телескопическая / Ціпок телескопічний / Teleszkópos nyél / Support telescopic / Teleskopová násada / Rukoväť teleskopická / Teleskopski ročaj / Teleskopinė rankena / Pagarinātājs teleskopisks / Teleskooplatt / Држачка телескоп. / Teleskopska ručka / Teleskopska rucka / Τηλεσκοπικός στυλός / Alargo telescópico / Manico telescópico / Pau telescópico / Tige télescopique / Teleskopisch houvast

TOPEX



Ref.	L [m]	☒	EAN
20B650	1 - 2	0/24	5902062005182

Uchwyty

Roller holder / Aufnahme für Wellen / Зажим для валиков / Тримач до валиків / Nyél festöhengerhez / Suport pentru rulouri / Držák na válečky / Objímka hriadelov / Ročaj za valje / Voleliu rankena / Veltņa ietvere / Vällihoidik / Држачка на фенерче / Drška za valjke / Hvat za valjke / Προσαρμογέας ρόουλων / Sujeción para rodillos / Impugnatura per rullo / Suporte de rolos / Manche à rouleaux / Houder voor rollers

TOPEX

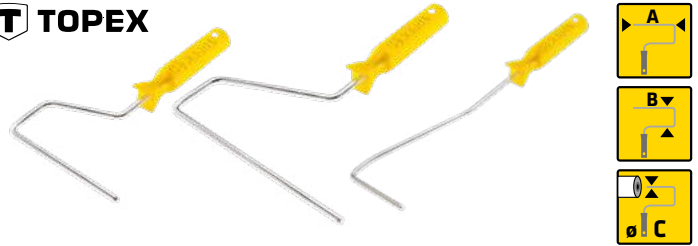

Ref.	A [mm]	B [mm]	C [mm]	☒	EAN
20B640	180	200	8	0/48	5902062006592
20B641	250	200	8	0/48	5902062006608
20B642	100	400	6	0/100	5902062006615

Zestaw malarski

Painter kit / Anstrich-Set / Набор маляра / Набор малярський / Festó készlet / Garnitură de vopsitorie / Malířská sada / Malarska súprava / Komplet za pleskarje / Kompletas dažymui / Krāsotāja komplekts / Maalriekomplekt / Бояджийски комплект / Slikarski set / Pribor za slikanje / Σετ βαφεία / Juego de herramientas para pintar / Set di pittura per vernici ad emulsione / Kit p. pintura / Jeu d'outils de peinture / Verfset

TOPEX

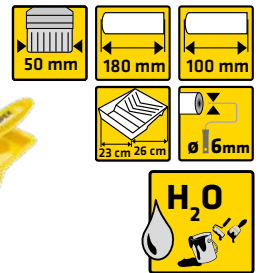

Ref.	☒	EAN
20B806	0/15	5902062006653

Folia malarska

Covering sheet / Malerfolie / Пленка малярная / Пліюка малярська / Takarófolia / Foie încheghere / Malířská fólie / Folia zákryvacia LDPE / Zaščitna folija / Plévelé dažymo darbams / Pléve krāsotājam / Katterie / Покривен наїлон / Zaštitna folija / Zastitna folija / Φύλλα επικάλυψης / Plástico de protección para pintores / Telo coprente / Papel de plástico p. pintura / Film plastique de protection pour la peinture / Schilderfolie

TOPEX



LDPE

Ref.	info	☒	EAN
23B145	0.02 mm, 4 x 5 m	0/20	5902062121660
23B175	0.007 mm, 4 x 5 m	0/50	5902062121653

Otwieracz puszek z farbą

Paint can opener / Farbdosenöffner / Открывалка для банок с красной / Ключ для відкривання банок з фарбою / Festékdoboz nyitó / Deschizator de cutii cu vopsea / Otvárač na konzervy s farbami / Otvírák na plechovky s barvou / Odpiráč posod z barvo / Atidarytuvas dažų skardinėms / Krāsu bundžu atvērējs / Värnipurgiavaja / Отварачка за кутии с боя / otvarač za spremnike s bojom / Otvarač za konzerve sa bojom / Ανοιχτήρι τερεξέδων μπογιάς / Abridor de latas de pintura / Apri latta / Abridor de latas de tinta / Ouvre-boîte peinture

TOPEX



Ref.	☒	EAN
20B671	100/300	5902062005281





POMIAROWE
MEASURING ИЗМЕРИТЕЛЬНЫЕ



Miara skladana

Wooden folding rule / Zollstock / Линејка складна / Линејка складна, дрвена / Famerce / Metru pliant lemn / Skládací metr / Meter skladaci / Zložljivi leseni meter / Medinis metras, sulankstomas / Metramērs saliekams / Kokkukäiv joonlaud / Метър / Drveni metar / Metar / Ξύλινο πλισσομένο μέτρο / Metro pieghevole de madera / Metro pieghevole in legno / Medidor dobrável / Mesure articulée / Vouwmeter

NEO
TOOLS



MID

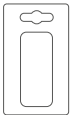
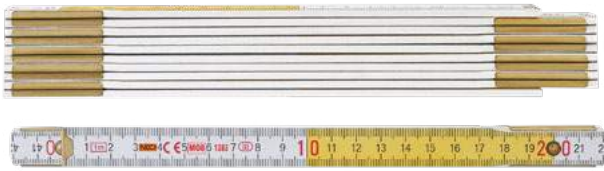

Ref.	L [m]	⊠	EAN
74-010	1	20/400	5907558400366
74-020	2	10/200	5907558400373

TOPEX

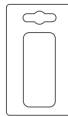

TOP TOOLS



Ref.	L [m]	kolor	⊠	EAN
26C005	1		0/200	5902062112422
26C006	2		0/284	5902062112439



Ref.	L [m]	W [mm]	⊠	EAN
26C011	1	16	24/240	5902062110015
26C012	2	16	12/120	5902062110022

Miara zvjijana

Pocket rule / Wickelmessband / Рулетка / Рулетка / Mérőszalag / Ruletă de măsurat / Měřidlo svinovací / Meter rolovací / Meter / Ruletë pëllënie / Mërlente rulete / Taskujoonlaud / Ponemka / Metar / Metar / Σπειρούμενη μετρητική ταινία / Flexómetro / Flessometro / Medidor enrolado / Mesure enroulée / Rolmaat

NEO
TOOLS



MID

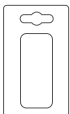

Ref.	L [m]	W [mm]	⊠	EAN
67-183	3	19	12/120	5907558425598
67-185	5	25	6/60	5907558425604
67-188	8	25	6/48	5907558425611

NEO
TOOLS



MID

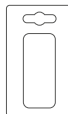

Ref.	L [m]	W [mm]	⊠	EAN
67-193	3	19	12/120	5907558425628
67-195	5	25	6/72	5907558425635
67-198	8	25	6/48	5907558425642

NEO
TOOLS



MID

Compact size

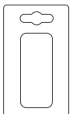

Ref.	L [m]	W [mm]	⊠	EAN
67-213	3	19	12/96	5907558425680
67-215	5	25	6/72	5907558425697
67-218	8	25	6/48	5907558425703

NEO
TOOLS

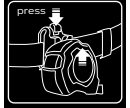

MID

NEO
TOOLS



MID

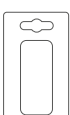

Ref.	L [m]	W [mm]	⊠	EAN
67-112	2	16	12/120	5907558400052
67-113	3	19	12/72	5907558400069
67-115	5	25	12/72	5907558400076
67-111	8	25	6/48	5907558400045

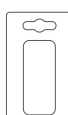

Ref.	L [m]	W [mm]	⊠	EAN
67-203	3	19	4/72	5907558425659
67-205	5	25	4/48	5907558425666
67-208	8	25	4/32	5907558425673

Miara zwijana

Pocket rule / Wickelmessband / Рулетка / Рулетка / Mérőszalag / Ruleta de măsurat / Měřidlo svinovací / Meter rolovací / Meter / Rulētē plieninē / Mērlente rulete / Taskujoonlaud / Ponemka / Metar / Metar / Σπειρούμενη μετρητική ταινία / Flexómetro / Flessometro / Medidor enrolado / Mesure enroulée / Rolmaat

TOPEX

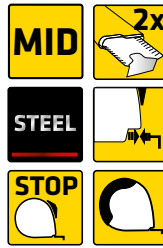

Ref.	L [m]	W [mm]	☒	EAN
27C302	2	16	10/100	5902062111760
27C303	3	16	10/100	5902062111777
27C305	5	19	10/100	5902062111784
27C308	8	25	6/48	5902062111791
27C310	10	25	6/48	5902062111807

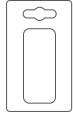

Miara zwijana - brelok

Pocket rule - trinket / Wickelmessband / Рулетка / Рулетка кишенькова / Mini mérőszalag / Ruleta - brelok / Miara zwijana / Rolovací meter privesok / Žepni meter / Rulētē plieninē / Mērlenta / Taskujoonlaud / Metar privezak / Σπειρούμενη μετρητική ταινία / Flexómetro / Mini flessometro / Medidor enrolado / Mesure enroulée / Rolmaat - hangend

TOPEX



x40

Ref.	L [m]	☒	EAN
27C001	1	40/1200	5902062008725

TOPEX



Ref.	L [m]	W [mm]	☒	EAN
27C342	2	16	12/120	5902062273420
27C343	3	19	12/120	5902062273437
27C345	5	25	12/72	5902062273451
27C340	10	32	6/48	5902062273406



TOPEX



Ref.	L [m]	W [mm]	☒	EAN
27C383	3	16	12/120	5902062273833
27C385	5	19	6/72	5902062273857
27C387	7,5	25	6/48	5902062273871

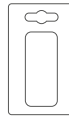

TOP TOOLS



Ref.	L [m]	W [mm]	☒	EAN
27C123	3	16	10/100	5902062112309
27C124	5	19	10/100	5902062112316

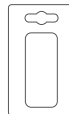

TOP TOOLS



Ref.	L [m]	W [mm]	☒	EAN
27C233	3	12,5	12/120	5902062111227
27C235	5	16	12/120	5902062111234

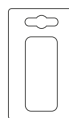

TOP TOOLS



Ref.	L [m]	W [mm]	☒	EAN
27C313	3	16	10/120	5902062273130
27C315	5	19	10/120	5902062273154
27C318	7,5	25	6/60	5902062273185

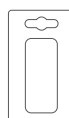

Taśma miernicza

Measuring tape / Messband / Измерительная лента / Стричка мірна / Mérőszalag / Ruletă / Měřicí páska / Meracia páska / Merilni trak / Metras / Měrle / Mõõdulint / Мерна лента / Traka za mjerenje / Traka za merenje / Μετρωταινία / Cinta larga / Rotella metrica / Fita de medição / Ruban de mesure / Meetband

NEO
TOOLS

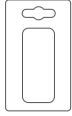

Ref.	L [m]	W [mm]	☒	EAN
68-030	30	13	10/20	5907558406696



NEO
TOOLS



Ref.	L [m]	W [mm]	☒	EAN
68-050	50	13	0/20	5907558406702



NEO
TOOLS

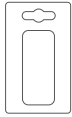

Ref.	L [m]	W [mm]	☒	EAN
68-120	20	9,5	12/48	5907558406719
68-130	30	9,5	12/48	5907558406726



NEO
TOOLS



Ref.	L [m]	W [mm]	☒	EAN
68-150	50	13	20/20	5907558406733



TOPEX



Ref.	L [m]	W [mm]	☒	EAN
28C412	20	12,5	4/40	5902062112149
28C413	30	12,5	5/40	5902062112156

TOPEX

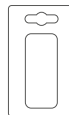

Ref.	L [m]	W [mm]	☒	EAN
28C533	30	13	0/10	5902062285331



TOPEX



Ref.	L [m]	W [mm]	☒	EAN
28C450	50	10	0/10	5902062112019

TOPEX



Ref.	L [m]	W [mm]	☒	EAN
28C550	50	13	0/20	5902062111289
28C551	100	13	0/10	5902062111975



TOP TOOLS



Ref.	L [m]	W [mm]	☒	EAN
28C512	20	12,5	0/64	5902062285126
28C513	30	12,5	10/40	5902062285133

TOP TOOLS



Ref.	L [m]	W [mm]	☒	EAN
28C534	50	10	0/16	5902062285348

Poziomnica

Sprit level / Richtwaage / Уровень / Рівень / Vízmeríték / Nivel spring / Vodováha / Vodováha / Libela / Gulsčiukas alumininis / Līmenrādis / Lood / Høvelup / Libela / Libela / Αλφάδι / Nivel / Livella / Nivel / Nivel / Staand waterpas

NEO
TOOLS

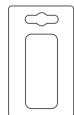

Ref.	L [cm]	⊠	EAN
71-001	25	10/60	5907558442175



NEO
TOOLS



Ref.	L [cm]	⊠	EAN
71-030	20	0/30	5907558410433



NEO
TOOLS

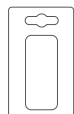

Ref.	L [cm]	⊠	EAN
71-000	23	10/40	5907558406450



NEO
TOOLS



Ref.	L [cm]	⊠	EAN
71-081	40	0/40	5907558442182
71-082	60	0/40	5907558442199
71-083	80	0/40	5907558442205
71-084	100	0/30	5907558442212
71-085	120	0/20	5907558442229
71-086	150	0/10	5907558442236
71-087	200	0/10	5907558442243



NEO
TOOLS



Ref.	L [cm]	⊠	EAN
71-061	40	10/60	5907558414967
71-062	60	10/60	5907558415971
71-063	80	10/40	5907558415988
71-064	100	10/60	5907558415995
71-065	120	10/20	5907558416008
71-066	150	0/10	5907558416015
71-067	200	0/10	5907558416022



NEO
TOOLS



Ref.	L [cm]	⊠	EAN
71-102	60	0/30	5907558442311
71-103	80	0/30	5907558442328
71-104	100	0/20	5907558442335
71-105	120	0/20	5907558442342
71-106	150	0/10	5907558442359



NEO
TOOLS



Ref.	L [cm]	⊠	EAN
71-092	60	0/40	5907558442250
71-093	80	0/40	5907558442267
71-094	100	0/30	5907558442274
71-095	120	0/20	5907558442281
71-096	150	0/10	5907558442298
71-097	200	0/10	5907558442304



NEO
TOOLS



Ref.	L [cm]	⊠	EAN
71-200	60	0/20	5907558445250



NEO
TOOLS



Ref.	L [cm]	⊠	EAN
71-112	60	0/30	5907558442366
71-113	80	0/20	5907558442373
71-114	100	0/20	5907558442380
71-116	150	0/10	5907558442397



Ref.	L [cm]	⊠	EAN
71-200	60	0/20	5907558445250

Poziomnica

Sprit level / Richtwaage / Уровень / Рівень / Vízmeríték / Nivel spring / Vodováha / Vodováha / Libela / Gulsčiukas aliumininis / Līmeņrādītis / Lood / Huelenup / Libela / Libela / Ακράδι / Nivel / Livella / Nivel / Nivelle / Staand waterpas

TOPEX



Ref.	L [cm]	H [mm]	W [mm]	☒	EAN
29C301	40	50	20	0/50	5902062293015
29C302	60	50	20	0/50	5902062293022
29C303	80	50	20	0/50	5902062293039
29C304	100	50	20	0/20	5902062293046
29C305	120	50	20	0/20	5902062293053

TOPEX



Ref.	L [cm]	H [mm]	W [mm]	☒	EAN
29C572	60	50	20	0/60	5902062016980

TOPEX



Ref.	L [cm]	H [mm]	W [mm]	☒	EAN
29C882	60	60	30	0/50	5902062888822
29C883	80	60	30	0/50	5902062888839
29C884	100	60	30	0/50	5902062888846

TOP TOOLS



Ref.	L [cm]	☒	EAN
29C401	40	0/60	5902062111388
29C402	60	0/60	5902062111395
29C403	80	0/60	5902062111401
29C404	100	0/60	5902062111418

Łata murarska

Traversing rule / Richtscheit / Правило строительное / Рейки мулярські / Ůlesléc / Dreptar (calapod) / Zednická lať / Lata murárska / Zidarska letev / Liniuotė mūriniųkui / Mūrnieka trapece / Joonlaud / Масmap / Specjalna libela / Specjalna libela / Μετρητής κλίσης / Reglón de albañil / Stadia / Remendo de pintura / Latte de maçons / Metselaarssabel

TOPEX

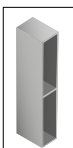

Ref.	L [cm]	H [mm]	W [mm]	☒	EAN
29C113	200	100	17	0/10	5902062870209
29C114	250	100	17	0/10	5902062870254

TOPEX



Ref.	L [cm]	H [mm]	W [mm]	☒	EAN
29C501	40	49	19	0/25	4008027040012
29C502	60	49	19	0/25	4008027040029
29C503	80	49	19	0/25	4008027040036
29C504	100	49	19	0/25	4008027040043
29C505	120	49	19	0/25	4008027040050
29C506	150	49	19	0/20	4008027040067
29C507	200	49	19	0/10	4008027040074

TOPEX



Ref.	L [cm]	H [mm]	W [mm]	☒	EAN
29C601	40				5902062995032
29C602	60	53	24	0/25	5902062112064
29C603	80	53	24	0/25	5902062112071
29C604	100	53	24	0/25	5902062112088
29C605	120	53	24	0/25	5902062112095
29C606	150	53	24	0/20	5902062112101
29C607	200	53	24	0/10	5902062112118

TOPEX



Ref.	L [cm]	H [mm]	W [mm]	☒	EAN
29C894	23	40	12	12/120	5902062880024

TOP TOOLS



Ref.	L [cm]	☒	EAN
29C893	23	24/144	5902062111623

TOPEX

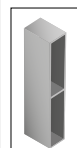

Ref.	L [cm]	H [mm]	W [mm]	☒	EAN
29C122	150	100	17	0/10	5902062872159
29C123	200	100	17	0/10	5902062872203
29C124	250	100	17	0/10	5902062872258
29C125	300	100	17	0/10	5902062872302

Łata murarska

Traversing rule / Richtscheit / Правило строительное / Реіки мулярські / Ōlesléc / Dreptar (calapod) / Zednická lat' / Lata murárska / Zidarska letev / Liniuotė mūrinių / Mūrnieka trapece / Joonlaud / Маснар / Specjalna libela / Specjalna libela / Μετρητής κλίσης / Reglón de albañil / Stadia / Remendo de pintura / Latte de maçons / Metselaarssabel

TOPEX

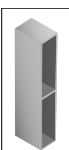

Ref.	L [cm]	H [mm]	W [mm]	☒	EAN
29C142	150	100	17	0/10	5902062874153
29C143	200	100	17	0/10	5902062874207
29C144	250	100	17	0/10	5902062874252
29C145	300	100	17	0/10	5902062874306

Poziomnica do słupków

Post level / Wasserwaage für Pfähle / Уровень складной магнитный с шарниром / Рівень складний магнітний з шарніром / Oszlopvízmérték / Nivelă pentru montante / Sloupková vodováha / Stĺpková vodováha / Libela za drogove / Kampinis gulščiuokas / Saliekamais magnēta līmeņrādis ar šarnīru / Postilood / Libela za stĺpove / Libela za stupove / Μαγνητική αλφάδι σωλήνων / Nivel para postes / Livella di controllo, mobile / Nivel / Nivelle à poteaux / Palenwaterpas

TOPEX

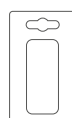

Ref.	info	☒	EAN
29C897	15-180°	0/100	5902062880154

Poziomnica laserowa

Laser level / Laserwasserwaage / Лазерный прибор / Рівень лазерний / Lézeres színtező / Nivelă cu laser / Laserová vodováha / Laserová vodováha / Laserska libela / Lazerinis lygio matuoklis / Lázera līmeņrādis / Laserlood / Лазерна либела / Laserska libela / Laserka libela / Αλφάδι λέιζερ / Nivel laser / Livella laser auto-levellante / Nivel de laser / Nivelle à laser / Laser waterpas

TOPEX

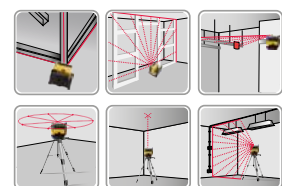

Ref.	dokładność [mm/m]	zasięg [m]	m [g]	☒	EAN
29C908	+/- 0,5	30	4,5	0/4	5902062299086

TOP TOOLS

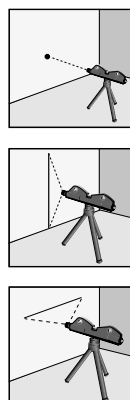

Ref.	☒	EAN
29C902	10/40	5902062889027

Łata tynkarska

Trapezoid floating rule / Anschlaglatte / Правило штукатурное / Реіки тинькарські / Kardeczni / Ráztaore trapezoidala / Strhovaci lat' na omítku / Lata lichobežníková / Zidarska letev / Liniuotė tinkavimo darbams / Armetēja trapece / Trapetsikujuline joonlaud / Маснар / Specjalna libela / Specjalna libela / Τραπεζοειδής μετρητής υποδιαστολής / Reglón de yesero / Stadia trapezoidale / Remendo de estuque / Latte de plâtrage / Stukadoorssabel

TOPEX

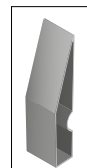

Ref.	L [cm]	H [mm]	W [mm]	☒	EAN
29C152	150	94	17	0/10	5902062875150
29C153	200	94	17	0/10	5902062875204
29C154	250	94	17	0/10	5902062875259
29C155	300	94	17	0/10	5902062875303

Poziomnica wodna

Water level / Wasserwaage / Гидроуровень / Рівень водяний / Vízmérték / Nivelă cu apă / Vodováha / Vodováha / Vodna libela / Vandens gulščiuokas / Ūdens līmeņrādis / Vesilood / Воден нивелур / Vodena libela / Libela vodena / Υδραυλικό αλφάδι / Nivel de agua / Livella ad acqua / Nivel de água / Nivelle à eau / Waterpas

TOPEX

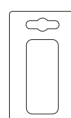

Ref.	L [m]	☒	EAN
29C871	15	0/10	5902062111982
29C872	20	0/10	5902062111999
29C873	25	0/10	5902062112002

TOPEX

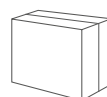
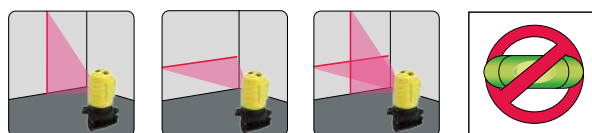

Ref.	dokładność [mm/m]	zasięg [m]	m [g]	☒	EAN
29C909	+/- 0,5	10	3,5	0/4	5902062299093

Laser krzyżowy

Cross line laser / Kreuzlaser / Перекрестный лазер / Лазер із перехресними променями / Keresztlaser / Laser în cruce / Křížový laser / Křížový laser / Křížni laser / Kryžminis lazeris / Krustveida lāzera nivelieris / Ristlaser / Лазер с крѣтосани линии / Křížni laser / Krstasti laser / Λείζερ σταυρού / Nivel laser de líneas en cruz / Livella laser a croce / Laser de linhas cruzadas / Laser en croix / Kruislaser

NEO
TOOLS



LASER	± 0,5 mm/m
AUTO	max 10m
± 5°	
2x AAA	

Ref. 75-100 0/12 EAN 5907558433999

NEO
TOOLS



LASER	± 0,3 mm/m
max 15m	
AUTO	± 4°
> 4°	
3x AA	

Ref. 75-101 0/12 EAN 5907558434002

NEO
TOOLS



LASER	4x BRIGHTER
max 15m	
± 0,5 mm/m	
AUTO	± 3,5°
2x AA	

Ref. 75-106 0/12 EAN 5907558439960

NEO
TOOLS



LASER	4x BRIGHTER
max 20m	
± 0,3 mm/m	
AUTO	> 4°
± 4°	
3x AA	

Ref. 75-107 0/12 EAN 5907558439939

Laser płaszczyznowy

Plane levelling laser / Oberflächenlaser / Лазерный построитель плоскостей / Лазер площинний / Vonallézer / Nivelă cu laser / Laser na měření rovnosti / Povrchový laser / Nivelirmi laser / Linijinis lazeris / Rotācijas lāzera nivelieris / Pinnalaser / Линеен лазер / Linijski laser / Površinski laser / Γραμμικό λείζερ 3 επιπέδων / Nivel laser de líneas / Livella laser orizzontale / Laser linear / Laser plan / Vlaklaser

NEO
TOOLS



LASER	max 15m
3x360°	± 0,3 mm/m
Li-ion USB charging	AUTO ± 4°

Ref. 75-104 0/8 EAN 5907558454406

NEO
TOOLS



LASER	3x360°
max 15m	AUTO ± 4°
± 0,3 mm/m	> 4°
Li-ion USB charging	

Ref. 75-103 0/12 EAN 5907558439953

NEO
TOOLS



LASER	± 0,3 mm/m
max 15m	> 4°
AUTO	3x AA
± 4°	

Ref. 75-102 0/4 EAN 5907558433999

NEO
TOOLS



LASER	max 20m
3x360°	± 0,3 mm/m
Li-ion USB charging	AUTO ± 4°

Ref. 75-109 0/8 EAN 5907558454413

Laser płaszczyznowy

Plane levelling laser / Oberflächenlaser / Лазерный построитель плоскостей / Лазер площинний / Vonallézer / Nivelă cu laser / Laser na měřeni rovnosti / Povrchový laser / Nivelirni laser / Linijinis lazeris / Rotācijas lāzera nivelieris / Pinnalaser / Линеен лазер / Linijski laser / Površinski laser / Γραμμικό λέιζερ 3 επιπέδων / Nivel laser de líneas / Livella laser orizzontale / Laser linear / Laser plan / Vlaklaser

NEO TOOLS



Ref. 75-108 0/12 EAN 5907558442403

Statyw

Stand / Gestell / Штатив / Штатив / Állvány / Stativ / Stativ / Stativ / Stativ / Stovas / Statīvs / Statiiv / Cmamus / Stativ / Stativ / Βραχίονας στήριξης / Soporte / Supporto a colonna / Suporte / Bâti / Steun

NEO TOOLS

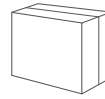

Ref. 75-110 0/15 EAN 5907558434026

Statyw rozporowy

Expansion pole / Expansions-Stativ / Распорный штатив / Штатив розпирний / Födémtámasz / Stativ expansiv / Rozpěrný stativ / Rozkladací statív / Stojalo / Išskleidžiamas trikojis / Teleskopiskais statīvs / Laiendatav stativ / Телескопична стойка / Teleskopski stativ / Rasklapano postolje / Πυλωμένο τρίποδο / Tripode con cangrejo / Puntella ad espansione / Tripé de expansão / Trépied entretoise / Klemstatief

NEO TOOLS

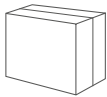

Ref. 75-113 0/6 EAN 5907558439946

NEO TOOLS



Ref. 75-115 0/4 EAN 5907558454468

Dalmierz laserowy

Laser distance meter / Laser-Entfernungsmesser / Лазерный дальномер / Далекомір лазерний / Lézeres távolságmérő / Telemetru cu laser / Laserový dálkoměr / Laserový dialkomer / Laserski daljinomer / Lazerinis tolimatis / Lāzera tālmēris / Laserlood / Лазерен далекомер / Laserski daljinomjer / Laserski daljinomer / Αποστάσιομετρο λέιζερ / Télémetro láser / Distanziometro laser / Medidor de distancias a laser / Télémètre à laser / Laser Afstandsmeter

NEO TOOLS

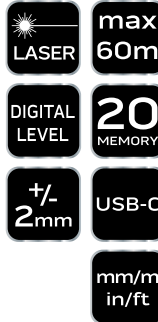

Ref. 75-201 0/20 EAN 5907558431841

NEO TOOLS

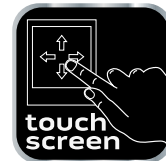
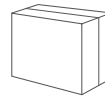

Ref. 75-203 0/50 EAN 5907558431865

NEO TOOLS



Ref. 75-202 8/48 EAN 5907558431858

Odległościomierz ultradźwiękowy

Distancer / Entfernungsmesser / Дальномер / Далекомір / Ultrahangos távolságmérő / Telemetru / Dálkoměr / Dialkomer ultrazvukový / Merilec oddaljenosti / Nuotolio matuoklis / Attāluma mēritājs / Mõõdik / Далекомер / Distancer / Daljinomer / Μετρητής αποστάσεων / Medidor ultrasonidos / Misuratore di distanza / Medidor de distância / Télémètre / Afstandsmeter

TOPEX

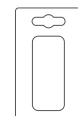

Ref. 31C902 L [mm] 127 W [mm] 55 Ra [m] 0,4 - 18 dokt. [%] 0,5 0/50 EAN 5902062319029

Okulary wzmacniające widoczność lasera

Laser view enhancing glasses / Очки для улучшения видимости лазера / Окуляри для поліпшення видимості лазера / Piros lézer láthatóságát növelő szemüveg / Ochelari de mărire vizibilitate laser / Okuliare zlepšujúce viditeľnosť lasera / Brýle / Okuliare / Očala / Akiniai / Brillen / Prillid / Очила / Naočale / Naočare / Γαλά / Gafas / Occhiali per potenziamento visibilità laser / Óculos / Lunettes / Bril

NEO
TOOLS



Ref. EAN
75-120 6/120 5907558454420

NEO
TOOLS



Ref. EAN
75-121 6/120 5907558454437

Tarcza celownicza do laserów

Target plate for lasers / Zielfeld für Laser / мишень для лазера / Цільова пластина для лазерів / Célzó tárcsa lézerhez / Placă țintă pentru lasere / Cielová doska pre lasery / Ciljna plošča za laserje / Цільна плоча за лазере / Πλάτο προορισμού για λέιζερ / Placa de destino para láseres / Piastra bersaglio per laser / Placa-alvo para lasers / Plaque cible pour lasers / Richtplaat voor lasers

NEO
TOOLS



Ref. EAN
75-130 10/300 5907558454444

NEO
TOOLS



Ref. EAN
75-131 10/300 5907558454451

Drogomierz

Measuring wheel / Wegstreckenmesser / Мерное дорожное колесо / Одометр / Mérőkerék digitális / Roată de măsurat distanțe reale / Trasoměr / Meracie koliesko / Merilno kolo / Kelio matuoklė / Ceļa mēritenis / Lābisāidutādik / Одометър / Ciklometar / Putomer / Τροχός μέτρησης αποστάσεων / Odómetro / Rotella di misurazione / Roda de medição / Odomètre (roue de mesure) / Meetwiel

TOPEX

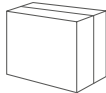

Ref. Ra [m] dokt. [%] EAN
31C800 0,1 - 9999 0,5 0/4 5902062318008

Cyrkiel ślusarki

Divider / Zirkel / Циркуль / Циркуль слюсарний / Körző / Compas pentru lăcătuș / Zámečnické kružítko / Zámotčnické kružítko / Šestilo / Skriestuvus šaltkalviui / Atslēdznieka cirkulis / Lukksepasirkel / Шлюперско перзен / Bravarški šestar / Bravarški šestar / Διαβήτης / Compás de trazado / Compasso / Compasso p. serrallharía / Compas de serrurier / Steekpasser

TOPEX

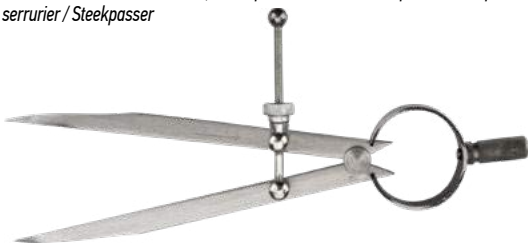

Ref. L [mm] L₁ [mm] Ra [mm] EAN
31C701 210 150 0 - 160 65° 10/100 5902062317018

Rysik traserski

Scriber / Trassierstift / Штихель трассировочный / Штихель трасувальний / Rajztű / Daltű / Nádrh / Rysovací ihla / Pisalo / Bréžiklis / Křída linija / Märknöel / Чертилка / Griftl / Igla za obeležavanje / Εργαλείο χάραξης / Punta de trazar / Tracciatore / Riscador para traçar / Pointe à tracer / Kraasnaald

TOPEX

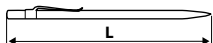

Ref. L [mm] EAN
31C703 150 0/300 5902062317032

Przyrząd do szacowania temperatury

Temperature estimator / Instrument zur Temperaturschätzung / Прибор для оценки температуры / Прилад для оцінки температури / Készülék hőmérsékletbecslésre / Instrument pentru estimarea temperaturii / Přístroj pro odhad teploty / Přístroj na meranie teploty / Instrument za merjenje temperature / Temperaturós ivertinimo prietaisais / Temperatūras novērtēšanas instruments / Temperatuuri hindamise seade / Устройство за оценка на температурата / Uredaj za procjenu temperature / Instrument za procenu temperature / Όργανο μέτρησης θερμοκρασίας / Herramienta para la estimación de temperatura / Strumento di stima della temperatura / Ferramenta estimadora de temperatura / Appareil d'évaluation température / Instrument voor temperatuurschatting

NEO
TOOLS



Ref. EAN
75-270 0/50 5907558455267

Pion murarski

Plumb bob / Senklot / Отвес каменщика / Висок мулярьський / Fügővas / Pírhghe echilibrabre / Olovnice / Olovnica / Svinčnica / Svambalas mūrīnīnkui / Atsvars celtniecības / Nöörlood / Отвес / Visak / Visak / Βαρύο νήματος στάθμης / Plomada de albañil / Bulbo / Tubo vertical de construção / Fil à plomb de maçons / Schietlood

TOPEX



Ref. m [g] EAN
30C643 275 6/48 5902062110923

Sznurek traserski

Chalk line / Trassierschnur / Шнур трассировочный / Шнур трасувальний / Kicsarószínör / Linie bătută cu cretă / Trasovací šňůra / Šnúrka značkovacia / Prah za označevanje / Virvė žymėjimai / Křída línija / Kriidinöör / Чертушка / Konac gradjevinski / Prah za obeleževanje / Σχοινί χάραξης / Cordon de trazar / Filo per pealvere tracciante / Corda p. Traçar / Fil à tracer / Metselsnoer

TOPEX

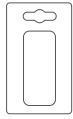

Ref.	L [m]	☒	EAN
30C630	30	30/60	5902062306302

TOP TOOLS

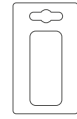

Ref.	L [m]	☒	EAN
30C615	15	0/90	5902062111852

TOP TOOLS

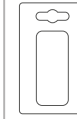

Ref.	L [m]	☒	EAN
30C614	30	0/180	5902062110978

Suwmiarka

Caliper / Messschieber / Штангенциркуль / Штангенциркуль / Tolómérő / Suport / Posuvné měřítko / Meradlo posuvné / Pomično merilo / Slankmatis / Bismērs / Mõõtesirkel / Шублер / Pomično mjerilo / Pomisno merilo / Αναλογικό παχύμετρο / Calibre / Calibro / Calibrador de corrediça / Pied à coulisse / Schuifmaat

NEO TOOLS

25 years
GUARANTEE

0-150
mm

±0,02
mm

mm
inch

STAINLESS
steel

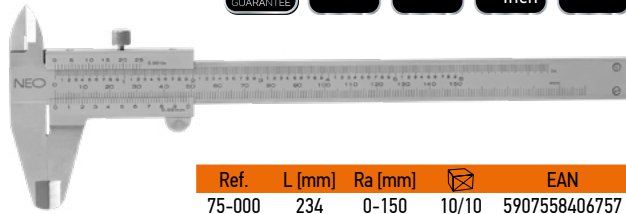
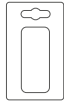

Ref.	L [mm]	Ra [mm]	☒	EAN
75-000	234	0-150	10/10	5907558406757

NEO TOOLS

25 years
GUARANTEE

0-150
mm

±0,02
mm

DIN
862

STAINLESS
steel

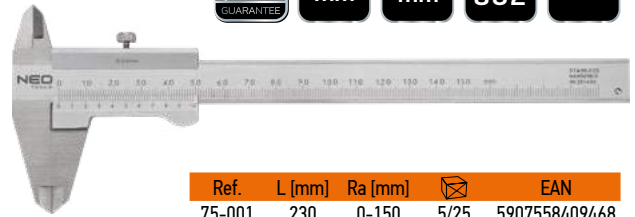
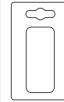

Ref.	L [mm]	Ra [mm]	☒	EAN
75-001	230	0-150	5/25	5907558409468

NEO TOOLS

25 years
GUARANTEE

0-150
mm

±0,02
mm

mm
inch

STAINLESS
steel

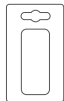

Ref.	L [mm]	Ra [mm]	☒	EAN
75-011	237	0-150	5/25	5907558408614

TOPEX

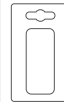

Ref.	L [mm]	Ra [mm]	dokt. [mm]	☒	EAN
31C615	230	0-150	0,05	10/40	5902062110435
31C616	230	0-200	0,05	5/50	5902062316165

TOPEX

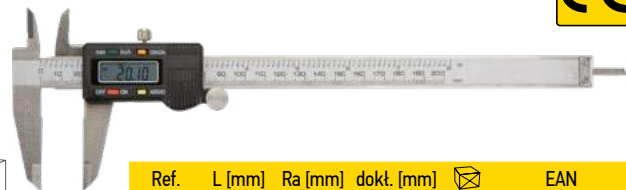

Ref.	L [mm]	Ra [mm]	dokt. [mm]	☒	EAN
31C625	290	0-200	0,02	0/50	5902062316257

TOPEX



Ref.	L [mm]	Ra [mm]	dokt. [mm]	☒	EAN
31C628	235	0-150	0,02	0/50	5902062111302

TOP TOOLS

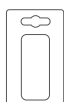

Ref.	L [mm]	☒	EAN
31C621	150	25/100	5902062112392

TOPEX



Ref.	L [mm]	Ra [mm]	dokt. [mm]	☒	EAN
31C627	230	0-150	0,02	0/30	5902062111296

Mikrometr

Micrometer / Mikrometer / Микрометр / Мікрометр / Micromètre / Micrometru / Mikrometr / Mikrometer / Mikrometer / Mikrometras / Mikrometras / Mikromeeter / Микрометър / Mikrometar / Mikrometar / Mikrómetro / Micrómetro / Micrometro / Micrómetro / Micromètre / Micrometer

TOPEX



Ref.	L [mm]	Ra [mm]	dokt. [mm]	☒	EAN
31C629	135	0-25	0,01	0/50	5902062111319

Linijka kątowa

Angular ruler / Winkellineal / Угловая линейка / Кутлова лінійка / Derékszög / Ríglá unghiulară / Úhlové pravítko / Uholové pravítko / Kotno ravnilo / Kampinē liniuotē / Leņķa lineāls / Nurk-joonlaud / Ёглова луня / Kutno ravnilo / Ugaoni lenjir / Γωνιακό χάρακα / Regla de ángulo / Righello ad angolo retto / Règua angular / Règle angulaire / Hoekliniaal

NEO
TOOLS

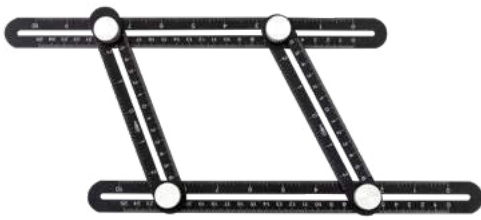

AL
cm/
inch
4-sided

Ref. EAN
72-350 10/60 5907558458787

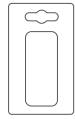

T TOPEX

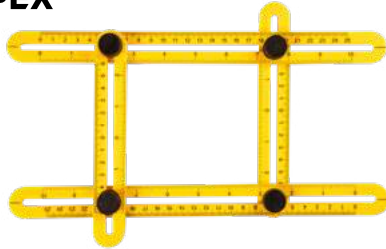

PP
MULTI
FUNCTION

Ref. EAN
16B476 0/90 5902062057372

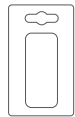

NEO
TOOLS

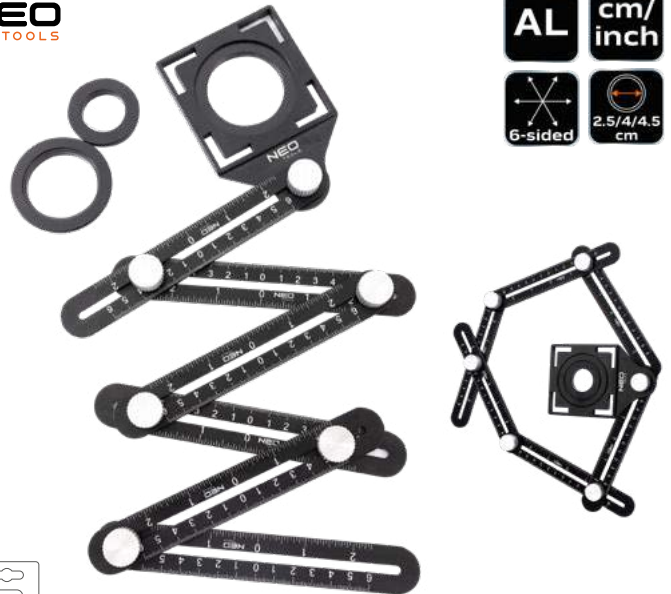

AL **cm/**
inch
6-sided **2.5/4/4.5**
cm

Ref. EAN
72-351 10/60 5907558458794

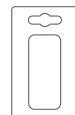

Przymiar liniowy

Steel rule / Lineal / Линейка / Лінійка стальна / Acélvonalzó / Metru de oțel / Měřidlo / Lineál nerezový / Ravnilo / Liniuotē iš nerūdijančio plieno / Lineāls / Terasjoonlaud / Луня / Ravnilo / Lenjir / Μετροταινία / Regla de medición / Riga lineare / Calibre para cordas / Réglet / Meetlat

NEO
TOOLS



AL **300**
mm **1:100** **1:200** **1:300** **1:400** **1:500** **1:600**

Ref. L [mm] EAN
72-205 300 20/160 5907558458732

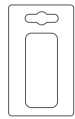

NEO
TOOLS

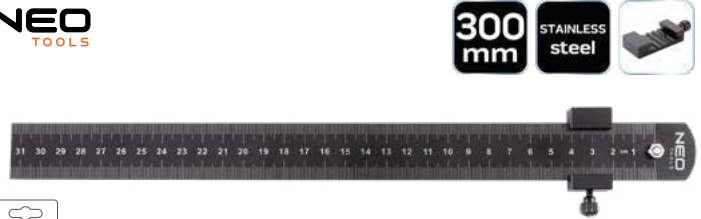

300 **STAINLESS**
mm **steel**

Ref. L [mm] EAN
72-200 300 20/80 5907558458725

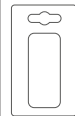

T TOPEX



Ref. L [mm] EAN
30C217 750 10/50 5902062111180



T TOPEX



STAINLESS
STEEL

Ref.	L [mm]		EAN
31C030	300	12/300	5902062890306
31C050	500	12/120	5902062890504
31C075	750	12/120	5902062890610
31C100	1000	12/96	5902062890627

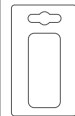

Κάτωννικ

Square / Winkel / Угольник / Коси́нець / Ácsderékszög / Colțar / Úhelník / Uholník / Kotno ravnilo / Kampainis Leņķis / Winkel / Ёгономер / Kutnik / Ugaonik / Γώνιωμας / Escuadra de techo / Profilato a l / Cantoneira / Cornière / Winkelhaak

NEO
TOOLS



STEEL **DIN** **PRECISION**
875/2

Ref. L EAN
72-021 100 x 70 0/100 5907558447187
72-022 150 x 100 0/50 5907558447194
72-023 200 x 130 0/25 5907558447200
72-024 250 x 160 0/25 5907558447217
72-025 300 x 200 0/10 5907558447224

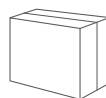

NEO
TOOLS



STEEL **DIN** **PRECISION**
875/2

Ref. L [mm] EAN
72-031 100 x 70 0/100 5907558447262
72-032 150 x 100 0/50 5907558447279
72-033 200 x 130 0/20 5907558447286
72-034 250 x 160 0/25 5907558447293
72-035 300 x 200 0/10 5907558447309

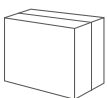

Kątownik

Square / Winkel / Угольник / Коси́нецъ / Ácsderékszög / Colțar / Úhelník / Uholník / Kotno ravnilo / Καμπαινίς Λεπίς / Winkel / Ёлномер / Kutnik / Угаоник / Γνώμονας / Escuadra de techo / Profilato a l / Cantoneira / Cornière / Winkelhaak

NEO TOOLS

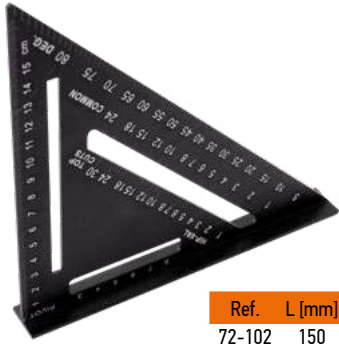

AL

150 mm



Ref.	L [mm]	⊠	EAN
72-102	150	10/80	5907558458749

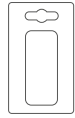

NEO TOOLS



AL

WITH RULER

150 mm

Ref.	L [mm]	⊠	EAN
72-105	150	4/24	5907558458756

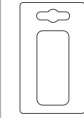

NEO TOOLS



STAINLESS steel



Ref.	⊠	EAN
72-109	5/40	5907558458756

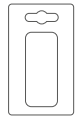

NEO TOOLS



AL

PRECISION

Ref.	⊠	EAN
72-115	0/60	5907558447408

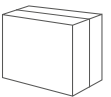

NEO TOOLS



300 mm

Ref.	L [mm]	⊠	EAN
72-120	300	10/30	5907558447378

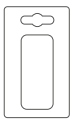

NEO TOOLS

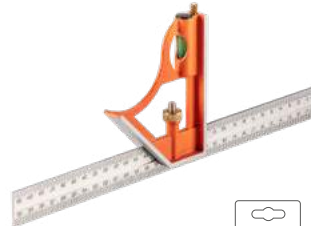

Ref.	L [mm]	⊠	EAN
72-125	300	10/60	5907558447385
72-126	600	10/60	5907558447392



NEO TOOLS



AL

Ref.	L [mm]	⊠	EAN
72-127	300	10/40	5907558458770

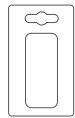

TOPEX

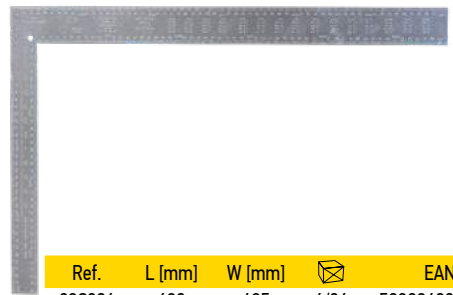

Ref.	L [mm]	W [mm]	⊠	EAN
30C326	609	405	6/36	5902062303264

TOPEX

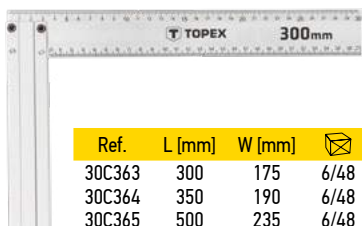

ALUMINIUM

Ref.	L [mm]	W [mm]	⊠	EAN
30C363	300	175	6/48	5902062893635
30C364	350	190	6/48	5902062893642
30C365	500	235	6/48	5902062893659

TOP TOOLS

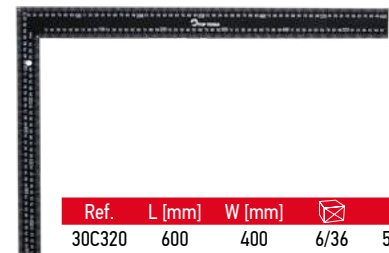

Ref.	L [mm]	W [mm]	⊠	EAN
30C320	600	400	6/36	5902062303202

TOP TOOLS

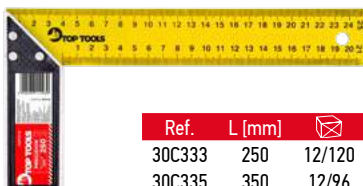

Ref.	L [mm]	⊠	EAN
30C333	250	12/120	5902062110930
30C335	350	12/96	5902062110718

TOP TOOLS



Ref.	L [mm]	⊠	EAN
30C330	200	20/200	5902062110916

Kątomierz

Protractor / Winkelmesser / Угломер / Транспортер / Szögmérő / Echer réglabil / Úhloňer / Uhlomer / Kotomer / Kampainis / Leņķmērs / Nurgamōdīk / Ёгломер / Kutomjer / Uglomer / Μοιρογνωμόνιο / Escuadra / Squadra regolabile in alluminio / Transferidor regulável / Rapporteur / Gradenboog

TOPEX

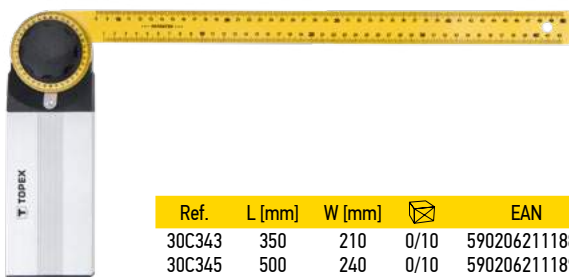

Ref.	L [mm]	W [mm]	⊠	EAN
30C343	350	210	0/10	5902062111883
30C345	500	240	0/10	5902062111890
30C347	750	340	0/10	5902062111906

TOPEX



Ref.	∠	L [mm]	L ₁ [mm]	⊠	EAN
31C700	180°	200	100	10/200	5902062317001

Miernik elektroniczny

Universal multimeter / Elektronikkessgerät / Мультиметр цифровой / Тестер универсальный / Multiméter univerzális / Multimetro universal / Elektronický měřicí přístroj / Univerzálny multimeter / Elektronski multimeter / Universals el. matuoklis / Multimets universāls / Universaalne multimeter / Мултиметр / Univerzalni multimetar / Ηλεκτρονικός μετρητής γενικής χρήσης / Multímetro digital / Misuratore universale / Medidor electrónico / Appareil de mesure électronique / Elektronisch meter

NEO TOOLS

V DC 0-300	V AC 0-300	A DC 0-10	A AC 0-10	Ω 0-20M	20n-1000μ	T °C -20-1000
------------	------------	-----------	-----------	---------	-----------	---------------

hFE	LCD 1999	Auto Range	Data hold function	▶
-----	----------	------------	--------------------	---

CAT III 300V	Nylon bag
--------------	-----------

x3 AAA



Ref.	⊠	EAN
94-001	0/26	5907558409154

TOPEX



V DC 0-300	V AC 0-300	A DC 0-10
Ω 0-2M	▶	BATT 1.5/9V
LCD 1999	CAT III 300V	9V

Ref.	⊠	EAN
94W104	25/50	5902062503510

TOPEX



V DC 0-300	V AC 0-300	A DC 0-10
A AC 0-10	Ω 0-20M	▶
BATT 1.5/9V	CAT III 300V	9V

Ref.	⊠	EAN
94W105	0/30	5902062503527

TOPEX

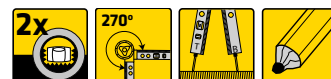

Ref.	L [mm]	W [mm]	⊠	EAN
30C321	500	500	0/10	5902062111883

Miernik cęgowy

Digital clamp meter / Messgerät / Клещи электроизмерительные / Кліщі струмовимірювальні / Multiméter digitális / Clește de măsurat / Klešťový měřicí přístroj / Kliešťový merací prístroj / Tokovne klešče / Matavimo replės / Strāvas aizsargknaibles / Мобілетангид / Електроизмерителни клеци / Mjerač za klijesta / Univerzalni multimetar / Αμεροαμπιόδα / Pinza ampimétrica / Misuratore di voltaggio digitale / Medidor de alicates / Appareil de mesure électrique à pince / Stroomtang

NEO TOOLS

V DC 0-600	V AC 0-600	A AC 0-300	Ω 0-20M	T °C -20-1000	Data hold function
------------	------------	------------	---------	---------------	--------------------

▶	Auto Range	LCD 1999
---	------------	----------

CAT II 600V	x3 AAA
-------------	--------



Ref.	⊠	EAN
94-002	0/20	5907558409161

NEO TOOLS

V DC 0-600	V AC 0-600	A DC 0-600	A AC 0-600	Ω 0-40M	Auto Range
------------	------------	------------	------------	---------	------------

LCD 3999	Synthetic leather bag
----------	-----------------------

Data hold function	CAT II 600V
--------------------	-------------

x2 AAA



Ref.	⊠	EAN
94-003	0/26	5907558407662

Cyfrowy miernik kąta

Digital angle gauge / Digitaler Winkelmesser / Электронный угломер / Цифровий кутомір / Digitális szögmérő / Dispositiv de măsurare unghi digital / Digitalní úhloňer / Digitalny uholnik / Digitalni merilnik kotov / Skaitmeninis kampo matuoklis / Digitālais leņķa mēritājs / Digitalne nurgamōdīk / Цифров ёгломер / Digitalni kutomjer / Digitalni merac ugla / Ψφιακός μετρητής γωνιών / Medidor digital de ángulo / Misuratore d'angolo digitale / Medidor digital de ángulos / Compteur d'angle numérique / Digitale hoekmeter

NEO TOOLS



LCD DISPLAY	U
-------------	---

x2 AAA	mm/m
--------	------

RESOLUTION 0.01°	measure freeze function
------------------	-------------------------

3 min AUTO OFF

Ref.	⊠	EAN
72-300	10/50	5907558455236

Szafka narzędziowa

Tool cabinet / Werkzeugschrank / Шкафчик для инструментов / Шафа інструментальна / Műhelykocsi / Dulap pentru scule / Skříňka na nářadí / Skrinka na náradie / Omatrica za orodje / Įrankių spintelė / Instrumentu skapis / Тööriistakapp / Шкафче за инструменти / Ormar za alate / Ormarić za alatke / Ντουλαράκι για εργαλεία / Armario de almacenaje para herramientas / Carrello porta utensili / Estante p. Ferramentas / Rmoire à outils / Gereedschapskast

NEO
TOOLS



25
years
GUARANTEE

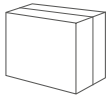

Ref.	D [mm]	W [mm]	H [mm]	capacity [kg]	☒	EAN
84-221	460	680	1030	280	0/1	5907558422238

NEO
TOOLS



25
years
GUARANTEE

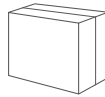

Ref.	D [mm]	W [mm]	H [mm]	capacity [kg]	☒	EAN
84-222	460	680	1030	280	0/1	5907558422245

NEO
TOOLS

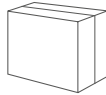

149 elements

1 szuflada / drawer / ящик



84-237

2 szuflada / drawer / ящик



84-239

84-238

84-230

84-231

84-232

3 szuflada / drawer / ящик



84-233

84-234

84-236

4 szuflada / drawer / ящик



84-249

Ref.	D [mm]	W [mm]	H [mm]	capacity [kg]	☒	EAN
84-221+G	460	680	1030	280	0/1	5907558425840

NEO
TOOLS

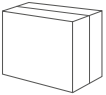

129 elements

1 szuflada / drawer / ящик



84-237

84-238

84-236

2 szuflada / drawer / ящик

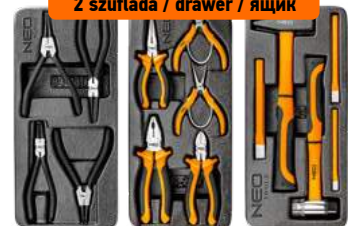

84-240

84-230

84-242

3 szuflada / drawer / ящик



84-235

84-234

84-232

4 szuflada / drawer / ящик



84-249

Ref.	D [mm]	W [mm]	H [mm]	capacity [kg]	☒	EAN
84-222+G	460	680	1030	280	0/1	5907558425857

Szafka narzędziowa

Tool cabinet / Werkzeugschrank / Шкафчик для инструментов / Шафа інструментальна / Műhelykocsi / Dulap pentru scule / Skříňka na nářadí / Skrinka na náradie / Omarica za orodje / Įrankių spintelė / Instrumentu skapis / Тоїристаккп / Шкафче за инструменти / Ormar za alate / Ormaric za alatke / Ντουλαράκι για εργαλεία / Armario de almacenaje para herramientas / Carrello porta utensili / Estante p. Ferramentas / Rmoire à outils / Gereedschapskast

NEO
TOOLS



25
years
GUARANTEE

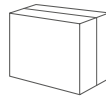

Ref.	D [mm]	W [mm]	H [mm]	capacity [kg]	☒	EAN
84-223	480	780	750	200	0/1	5907558422276

NEO
TOOLS

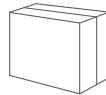

126 elements

1 szuflada / drawer / ящик

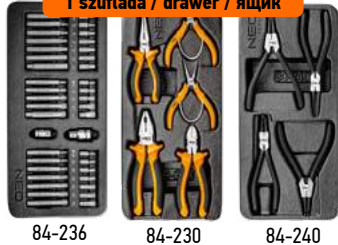

84-236



84-230



84-240

2 szuflada / drawer / ящик



84-238



84-232



84-231

3 szuflada / drawer / ящик



84-243



84-234



84-235

4 szuflada / drawer / ящик



84-249

Ref.	D [mm]	W [mm]	H [mm]	capacity [kg]	☒	EAN
84-223+G	480	780	750	200	0/1	5907558427097

NEO
TOOLS



25
years
GUARANTEE

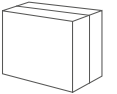

Ref.	D [mm]	W [mm]	H [mm]	capacity [kg]	☒	EAN
84-220	460	810	980	300	0/1	5907558418293

Wózek warsztatowy

Workshop trolley / Werkstattrollwagen / Тележка для инструмента / Візок інструментальний / Műhely kocsi / Cărucior de atelier / Dilenský vozík / Dielenský vozík / Delavniški voziček / Vežimėlis dirbtuvėms / Instrumentu ratiņi / Тоққожақару / Работна кољичка / Kolica za radionicu / Radionička kolica / Καρότσι εργαλείων / Carrito de taller / Carrello portautensili / carrinho de oficina / Chariot d'atelier / Werkplaatskar

NEO
TOOLS

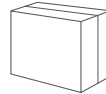

Kompatybilne z wkładkami narzędziowymi NEO
Compatible with NEO tool inserts
Совместимость с инструментальными вставками NEO

Ref.	D [mm]	W [mm]	H [mm]	capacity [kg]	☒	EAN
84-229	390	630	810	130	0/1	5907558435610

Szczypce

Pliers set / Zange / Клещи / Пласскозубци, набор / Fogókészlet / Set clește plat / Klešče / Kliešte, súprava / Klešče / Replės / Кпаиблү комплекts / Nāpitsate komplekt / Щипцы / Klijesta / Klesta set / Συλλογή πενσών / Alicates / Pinza / Pinças / Pince / Tangen

NEO
TOOLS

25
years
GUARANTEE

TÜV Rheinland
CERTIFIED

x5

55-60
HRC

DIN
5745

DIN
5746

DIN
5749

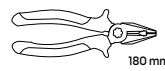

180 mm

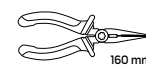

160 mm

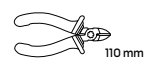

110 mm

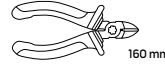

160 mm

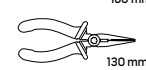

130 mm

Ref.	☒	EAN
84-230	0/10	5907558424270

Szczypce do pierścieni osadczyc

Circlip pliers / Zange für Stellringe / Щипцы для стопорных колец / Щипцы для стопорних кілець / Zęgeryűrű fogókészlet / Set clește cu spirală / Kleště pro stavěcí kroužky / Segerky vonkajšie rovné / Kleště seger / Replės žiedams / Sprosgredzenu stangas / Vedrunāpitsads / Клеуци Зезеп / Kružna Ključa / Kružna klesta / Ασφαλειοταιμίδες / Alicates para anillos de asiento / Set di pinze per anelli elastici / Pinças p. Anéis / Pince pour bagues de retenue / Tang voor dopringen

NEO
TOOLS

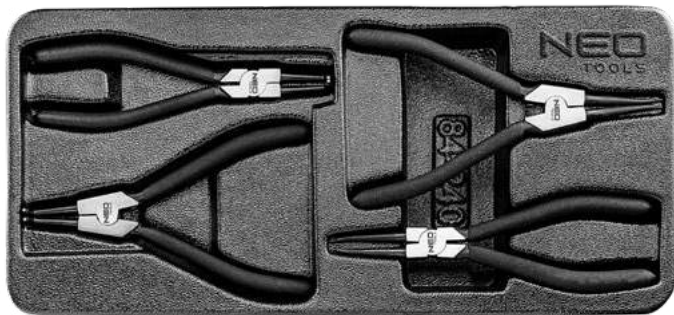

180 mm, zewnętrzne, proste / external, stright tip / щипцы для внешних/прямые
170 mm, zewnętrzne, wygięte / external, bent tip / щипцы для внешних/загнутые
180 mm, wewnętrzne, proste / internal, stright tip / щипцы для внутренних/прямые
170 mm, wewnętrzne, wygięte / internal, bent tip / щипцы для внутренних/загнутые

Ref.	📦	EAN
84-240	0/10	5907558424379

Zestaw narzędzi

Tools set / Werkzeugsatz / Набор инструментов / Набор інструментів / Szerszámkészlet / Set scule de grădini / Sada nářadí / Súprava nářadia / Garnitura orodja / Įrankių komplektas / Instrumentu komplekts / Tööriistakomplekt / Геодор комплект / Set uređaja / Set alata / Συλλογή εργαλείων / Juego de herramientas / Set utensili / Kit de ferramentas / Jeu d'outils / Gereedschapsset

NEO
TOOLS

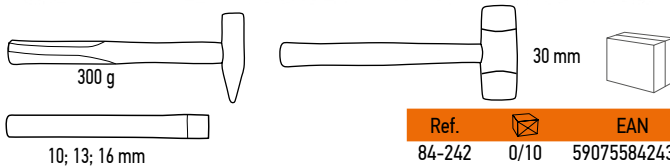

Ref.	📦	EAN
84-242	0/10	5907558424393

Pilniki

Files / Feilen / Напильники / Напильки / Reszelő készlet / Pile / Pilniki / Pilniky / Pile / Dildes / Vites / Viilid / Пилу / Turpije / Турпје / Лимес / Sopletes / Set di lime / Limas / Limes / Vijlen

NEO
TOOLS

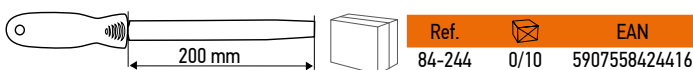
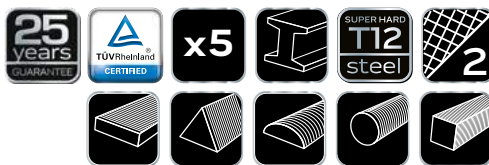

Wkrętaki

Screwdriver set / Schraubendreher / Отвертки / Відкрутки, набір / Fogókészlet / Set şurubeli / Šroubováky / Súprava skrutkovačov / Garnitura izvijačev / Atsuktuvai / Skrutvgriežu komplekts / Kruvikeerajate komplekt / Отвертки компл. / Odvijaići / Odvijac set / Συλλογή από κατασβίδια / Destornilladores / Set giravite piatti / Chaves de fenda / Tournevis / Schroevendraaiers

NEO
TOOLS



Ref.	📦	EAN
84-231	0/10	5907558424287

NEO
TOOLS



Ref.	📦	EAN
84-232	0/10	5907558424294

NEO
TOOLS



Ref.	📦	EAN
84-247	0/10	5907558424447

Klucze nasadowe

Drive socket set / Steckschlüssel / Набор сменных головок / Ключи торцевые / Dugókulcskészlet / Trusa tubulara / Nástrčné kľúče / Nástrčné kľúče / Nasadni ključiči / Veržlerakcio antgaliai / Nomaināmo galvu komplekts / Padrūnājums / Сменная накруйка на ключовое / Nasadni ključevci / Ključevci natikači / Set ме карубјака / Llaves de vaso / Set bussole / Chaves articuladas / Clefs à douilles / Dopsleutels

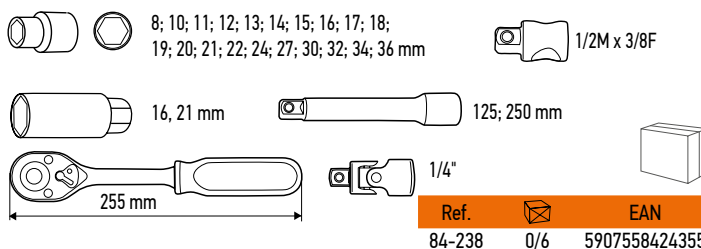
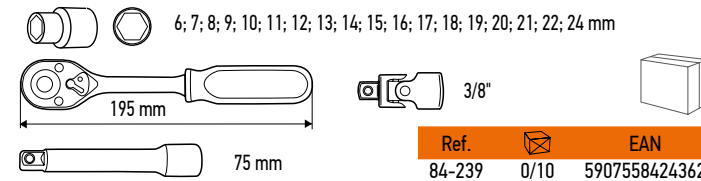
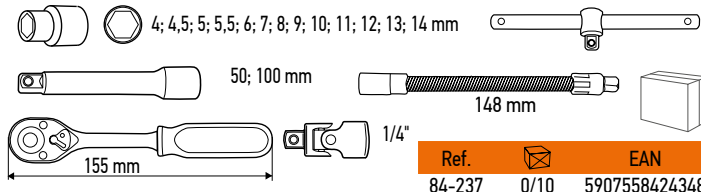

Nasadki udarowe

Impact sockets / Schlagaufsätze / Nasadki udarowe / Патрони перфораторни / Gépi dugókulcs készlet / Brătare percutate / Přiklepové nástavce / Přiklepové nástavce / Udarni nasadni ključiči / Kalimo antgaliai / Triecienuzgaļi / Löökotsakud / Ударни наставкаи / Udarni nasadni nastavci / Udarne kapice / Υποδοχές κρουστικού ανταλλακτικού / Llaves de vaso para atornilladores de impacto / Set bussole a percussione / Bocais de impacto / Douilles de choc / Slagdoppen

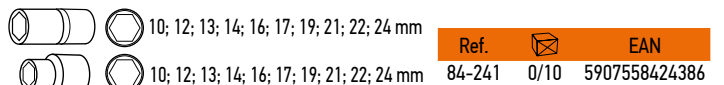

Nasadki sześciokątne długie

Hexagonal sockets / Sechskantaufsätze / Головки сменные шестигранные / Nasadki шестигранные / Dugókulcs hosszú készlet / Capete tubulara hexagonale / Šestihranné nástavce / Šestihranné nástavce / Šestkotni nasadni ključiči / Šešiakampiai antgaliai / Sešstūra nomaināmo galvas / Kuuskantpadrūnidi / Шестогълни наставкаи / Šesterokutne kapice / Šestougaone nasadke / Καρυδάκια εξάγωνα / Vasos hexagonales / Set bussole / Bocais hexagonais / Douilles à 6 pans / Zeskant doppen

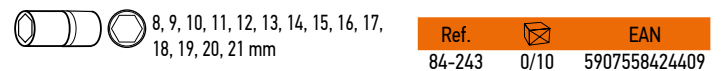
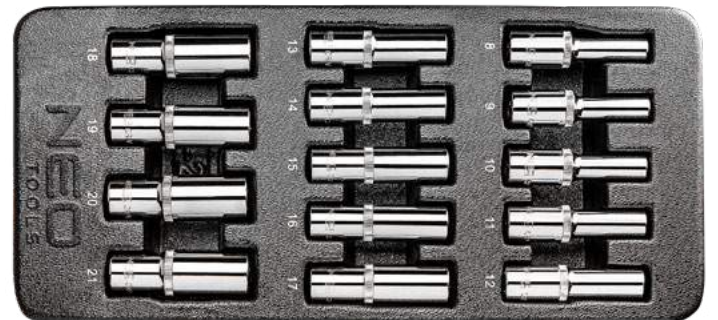

Końcówki wkrętakowe

Driver bits / Einsätze für Schraubendreher / Nasadki / Наконечники викротови / Bitkészlet / Set biti / Šroubovákové nástavce / Skrutkovnice nástavce / Nastavki za izvijače / Atsuktuvo antgaliai / Skrūvgrieža uzgāļi / Krutikeerajatsakud / Накруйници за отвёртка / Nastavci za odvijač / Nastavci za odvijač / Καταβιδιώτες / Puntas destornilladoras / Set inserti / Ponteiros chave de fenda / Embouts de tournevis / Schroevendraaierendstukken

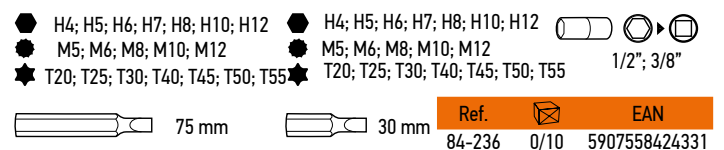
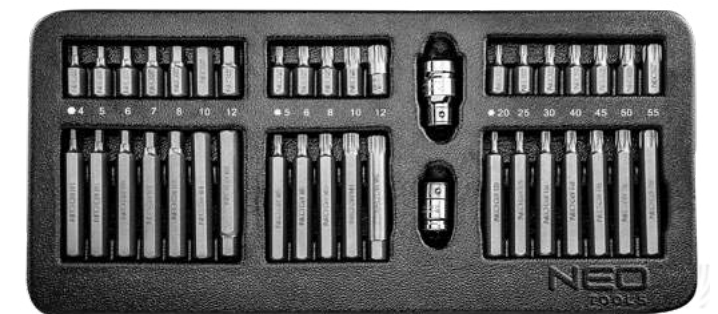

Klucze płasko-oczkowe

Ratchet wrench set / Maul-Ringschlüssel / Ключи комбинированные / Ключи ріжково-накидні, набір / Csillag-villaskulcs készlet / Set chi cu clichet / Očkoploché klíče / Súprava OP račňových kľúčov / Kľuč viličasto-obročni / Raktas plokščias - kilpinis / Kombinēto atslēgu komplekts / Pörkmutrivõtmete komplekt / Ключ звездогаечен / Set kľuččeva / Kľuč kombinovani / Συλλογή πολυγώνων καστανιάς / Llaves combinadas (de estrella y a carraca abierta) / Set chiavi combinate / Chaves planas-de luneta / Clefs à fourche polygonales / Moersleutels

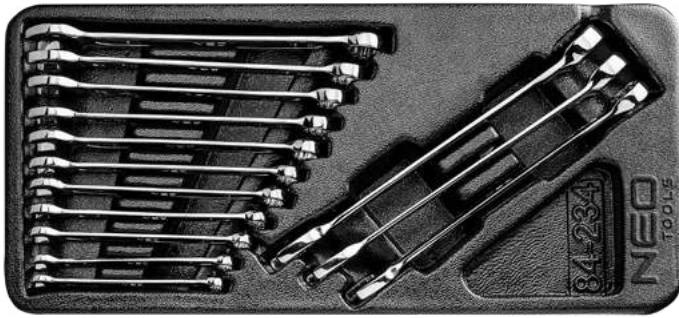

6x100; 7x110; 8x120; 9x130; 10x140; 11x150; 12x160; 13x170; 14x180; 15x190; 16x200; 17x210; 18x220; 19x230 mm

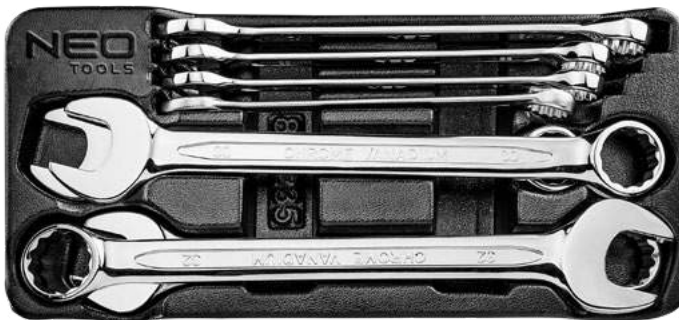

20x240; 21x250; 22x260; 24x280; 27x310; 29x340; 30x340; 32x360 mm



Klucze oczkowe odgięte

Offset ring spanner set / Ringschlüssel gebogen / Ключи накидные коленачатые / Ключі накидні колінчасті, набір / Csillagkulcs készlet / Set chi inelare de deviație / Očkový klíč vyhnutý / Súprava očkových kľúčov / Garnitura obročnih kľučev, upogrnjenih / Kilpinii, lenktü raktü komplektas / Kombinēto izliekto atslēgu komplekts / "Ofset" mutrivõtmete komplekt / Ключ луна / Kľuč okasti / Kľuč okasti set / Συλλογή κυρτών πολυγώνων κλειδιών με κεκλιμένη κεφαλή / Llaves de estrella, acodadas / Set chiavi inclinate ad anello / Chaves de luneta curvadas / Clefs polygonales contre-coudées / Gebogen ringsleutels

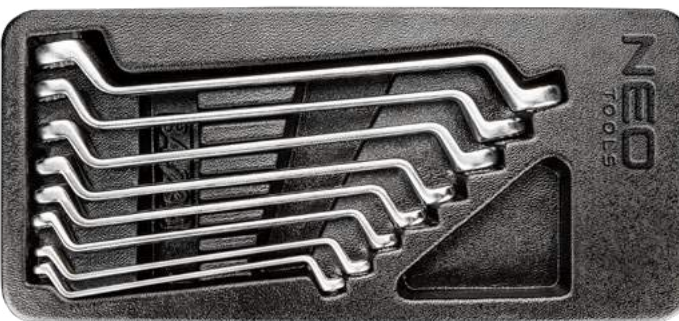

6x7; 8x9; 10x11; 12x13; 14x15; 16x17; 18x19; 20x22 mm



Narzynki i gwintowniki

Tap and die set / Schneideisen und Gewindebohrer / Плашки и метчики / Ποαναχники и плашки, набір / Menetkészítő készlet / Set scule tăiere filet interior și exterior / Závítnice a zavitníky / Súprava zavitníkov / Garnitura vrezníkov in nareznikov navoja / Srieggpjovës ir sriegigkliai / Vītngriežu komplekts / Kraani ja valuvormi komplekt / Метчици и плашки / Nareznice i ureznice set / Set ureznika i nareznika / Ελικοκόφτες και καλωύζα / Cojinetes y machos de roscar, juego / Set di filiere a maschi / Cassonetes e roscas / Filières et tarauds / Snijplaat en schroefdraad snijtoestel

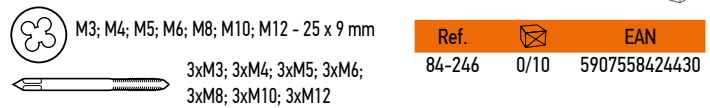
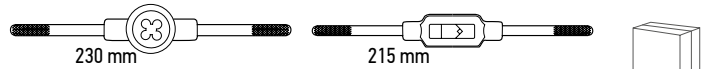
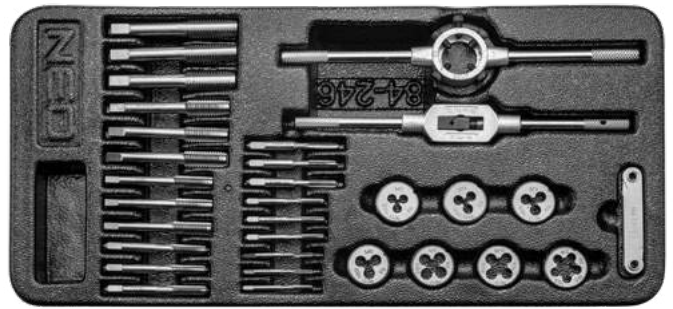

Wkład profilowany

Profiled insert / Profileinsatz / Профилированный вставной элемент / Органайзер / Tároló rekeszes tálcá / Cartuş profilat / Profilovaná vložka / Profilovaná vložka / Profiliran vložek / Profiluotas įdėklas / Profilēts ieliekamais elements / Profilitud tihend / Профилен элемент / Profilirani umetak / Profilisani umetak / Διατρητο ένθετο εξάρτημα / Bandeja clasificadora perfilada / Vassoio / Cartuco perfilado / Cylindre profilé / Geprofileerde inzetdeel

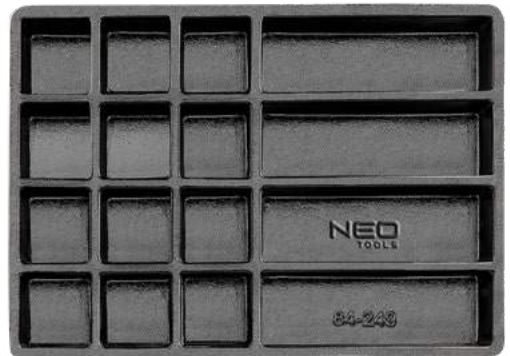

550x386 mm



Szafka serwisowa 6 szuflad (nadstawka)

Service cabinet 6 drawers (extension) / Serviceschrank 6 Schubladen (Erweiterung) / Шкаф для обслуживания 6 ящичков (верхний блок) / Службово шафа 6 висувних ящичків / Szervizszekrény 6 fiókkal (felső egység) / Dulap de service 6 sertare (extensie) / Servisni skřínka 6 zásuvek (prodloužení) / Servisná skrinka 6 zásuviek (vysuv) / Servisna omara 6 predalov (podaljšek) / Aptarnavimo spinta 6 stalčiai (prailginimas) / Аркалошанас скапис 6 atvilktnes (pagarinājums) / Teeninduskapp 6 sahtlit (pikendus) / Сервізен шкаф 6 чекмеджета (удължение) / Servisni ormar 6 ladica (prodlužetak) / Сервисни ормар 6 фиока (продужетак) / Σέρβις 6 αικράρια (επέκταση) / Armario de servicio 6 cajones (extensión) / Mobile di servizio 6 cassetti (allunga) / Gabinete de serviço 6 gavetas (extensão) / Armoire de service 6 tiroirs (extension) / Servicekast 6 lades (uitbouw)



Kompatybilne z wkładkami narzędziowymi NEO
Compatible with NEO tool inserts
Совместимость с инструментальными вставками NEO



Szafka narzędziowa

Tool cabinet / Werkzeugschrank / Шкафчик для инструментов / Шафа інструментальна / Műhelykocsi / Dulap pentru scule / Skříňka na nářadí / Skrinka na náradie / Otarica za orodje / Įrankių spintelė / Instrumentu skapis / Тööriistakapp / Шкафче за инструменти / Ormar za alate / Ormarić za alatke / Ντουλαράκι για εργαλεία / Armario de almacenaje para herramientas / Carrello porta utensili / Estante p. Ferramentas / Rmoire à outils / Gereedschapskast

TOPEX

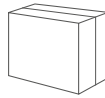
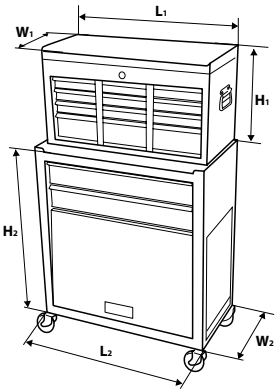

Ref.	L1 [cm]	L2 [cm]	W1 [cm]	W2 [cm]	H1 [cm]	H2 [cm]	☒	EAN
79R500	60,0	61,5	26,0	33,0	34,0	66	0/1	5902062795007

TOPEX

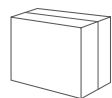

Ref.	☒	EAN
79R501	0/1	5902062035783

TOPEX



1 szuflada / drawer / ящик



2 szuflada / drawer / ящик



3 szuflada / drawer / ящик



Ref.	☒	EAN
79R502	0/1	5902062036582

455 elements
105 tools + 350 accessories

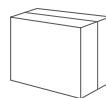

Szczypcy

Drive socket set / Steckschlüssel / Набор сменных головок / Ключи торцевой / Fogókészlet / Trusa tubulare / Nástrčné kľúče / Nástrčné kľúče / Nasadni ključji / Veržlerakcio antgaliai / Normaināmo galvu komplekts / Padrūpinvõtmed / Сменная накрайница за ключове / Nasadni ključevci / Ključevci natikači / Σετ με καρδιάκια / Llaves de vaso / Set pinze / Chaves articuladas / Clefs à douilles / Dopsleutels

TOPEX

x5

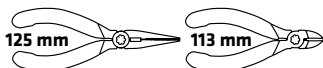

Ref. 79R512 0/10 EAN 5902062035530

Klucze nasadowe

Drive socket set / Steckschlüssel / Набор сменных головок / Ключи торцевой / Dugókulcskészlet / Trusa tubulare / Nástrčné kľúče / Nástrčné kľúče / Nasadni ključji / Veržlerakcio antgaliai / Normaināmo galvu komplekts / Padrūpinvõtmed / Сменная накрайница за ключове / Nasadni ključevci / Ključevci natikači / Σετ με καρδιάκια / Llaves de vaso / Set utensili / Chaves articuladas / Clefs à douilles / Dopsleutels

TOPEX

CrV

x21

1/2"

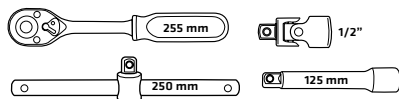
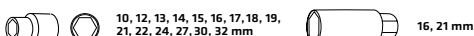

1/2"

Ref. 79R510 0/6 EAN 5902062035592

Klucze nasadowe

Drive socket set / Steckschlüssel / Набор сменных головок / Ключи торцевой / Dugókulcskészlet / Trusa tubulare / Nástrčné kľúče / Nástrčné kľúče / Nasadni ključji / Veržlerakcio antgaliai / Normaināmo galvu komplekts / Padrūpinvõtmed / Сменная накрайница за ключове / Nasadni ključevci / Ključevci natikači / Σετ με καρδιάκια / Llaves de vaso / Set utensili / Chaves articuladas / Clefs à douilles / Dopsleutels

TOPEX

CrV

x21

1/4"

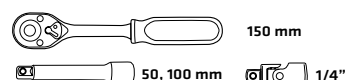

1/4"

Ref. 79R511 0/10 EAN 5902062035585

Wkrętaki

Screwdriver set / Schraubendreher / Отвертки / Відкритки, набір / Csavarhúzókészlet / Set şurubelişte / Šroubováky / Sada skrutkovačov / Komplet izvijačev / Atsuktuvų komplektas / Skrivn griežu komplekts / Kruvikeerjate komplekt / Отвертки компл. / Odvijajući set / Odvijac set / Συλλογή καταβιδιών / Destornilladores / Set giraviti / Chaves de fenda / Tournevis

TOPEX

CrV

x6



- 3.2 x 75 mm
- 4.0 x 100 mm
- 5.0 x 38 mm
- 5.0 x 100 mm
- 6.5 x 100 mm
- 8.0 x 150 mm



Ref. 79R513 0/10 EAN 5902062035547

TOPEX

CrV

x6



- PH0 x 75 mm
- PH1 x 100 mm
- PH2 x 38 mm
- PH2 x 100 mm
- PH2 x 150 mm
- PH3 x 150 mm



Ref. 79R514 0/10 EAN 5902062035554

Zestaw narzędzi

Tools set / Werkzeugsatz / Набор инструментов / Набор инструментов / Szerszámkészlet / Set scule de grădiniă / Sada náradí / Súprava náradia / Garnitura orodja / Įrankių komplektas / Instrumentu komplekts / Тööriistakomplekt / Геодре компнект / Set uređaja / Set alata / Συλλογή εργαλείων / Juego de herramientas / Set utensili / Kit de ferramentas / Jeu d'outils / Gereedschapset

TOPEX

CrV

x29



- T10, T15, T20, T25, T27, T30, T40, T45, T50

1/2"
10, 13, 16, 17, 19, 24 mm

- P21, P22, P23, P24
- H3, H4, H5, H6, H7, H8

1/4"

- M5, M6, M8, M10

Ref. 79R515 0/10 EAN 5902062035561

Klucze płasko-oczkowe

Ratchet wrench set / Maul-Ringschlüssel / Ключи комбинированные / Ключи рижково-накидни, набір / Csillag-villáskulcs készlet / Set chei cu clichet / Očkoploché klíče / Súprava DP ráčňových klúčov / Kľuč viličasto-obročni / Raktas plokščias - kilpinis / Kombinēto atslēgu komplekts / Põrkmutrivõtmete komplekt / Ключ звездогоачечен / Set ključeva / Kľuč kombinovani / Συλλογή πολυγώνων καστανιάς / Llaves combinadas (de estrella y a carraca abierta) / Set chiavi combinate / Chaves planas-de luneta / Clefs à fourche polygonales / Moersleutels

TOPEX

CrV x14

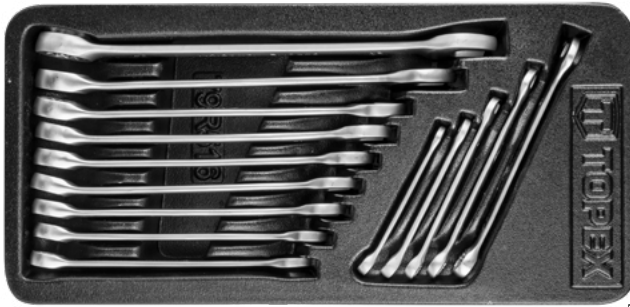

6 x 100, 7 x 100, 8 x 110, 10 x 125,
12 x 140, 13 x 145, 14 x 160, 15 x 175,
16 x 185, 17 x 205, 18 x 205, 19 x 230,
22 x 260, 24 x 280 mm

Ref. EAN
79R516 0/10 5902062035578

Młotki

Hammer / Hammer / Молоток / Молоток / Kalapács készlet / Ciocan / Kladívko / Kladivo / Kladivce / Plaktukas / Āmurs / Vasar / Чук / Čekić / Čekić / Συρπί / Martillo / Set martelli / Martelo / Martelet / Hamer

TOPEX

x2

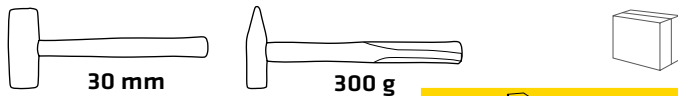

Ref. EAN
79R517 0/10 5902062035608

Nitownica

Riveter / Nietmaschine / Заклепочник / Клепальный инструмент / Popszegecs húzó / Mašinà de nituit / Nýtovačka / Kliešte nitovacie ocelové / Pištola za kovičenje / Kniediklis / Kniežu stangas / Needitangid / Нитачка / Klijesta za zakovice / Pistolj za pop nitne / Ηλοι / Remachadora / Set rivettatrice e rivetti / Rebitadora / Riveuse / Klinknagelmaschine

TOPEX

AI



Ref. EAN
79R518 0/10 5902062035615

Haki

Hooks / Hacken / Крюки / Гаки / Horgok / Cârlige / Háky / Skoby / Kľjuke / Kabliai / Āķi / Haagid / Кукы / Kuke / Кукы / Гăвтăри / Ganchos / Ganci / Anzais / Crochets / Haken

NEO TOOLS



x3 40 mm

for 84-500 84-501

Ref. L [mm] EAN
84-096 40 0/65 5907558439267

NEO TOOLS

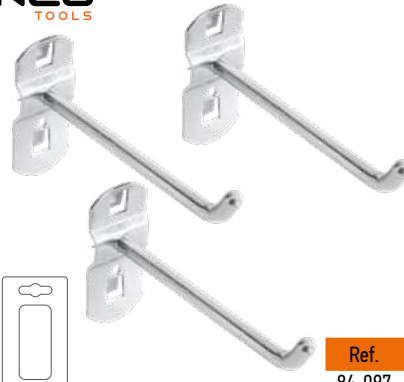

x3 85 mm

for 84-500 84-501

Ref. L [mm] EAN
84-097 85 0/50 5907558439274

NEO TOOLS



x5 40 mm

for 84-500 84-501

Ref. L [mm] EAN
84-095 40 0/100 5907558439250

NEO TOOLS



for 84-500 84-501

Ref. EAN
84-092 8/40 5907558439151

NEO TOOLS

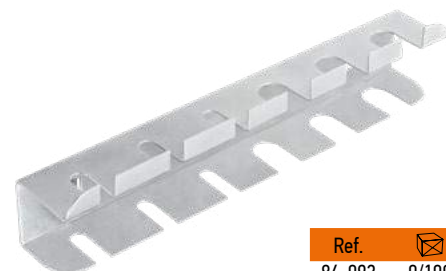

for 84-500 84-501

Ref. EAN
84-093 0/100 5907558439168

Haki
 Hooks / Hacken / Крючки / Гаки / Horgok / Cârlige / Háky / Skoby / Kljuka / Kabliari / Āķi / Haagid / Кукы / Kuke / Kuke / Γάντζοι / Ganchos / Ganci / Anzóis / Crochets / Haken

NEO
 TOOLS

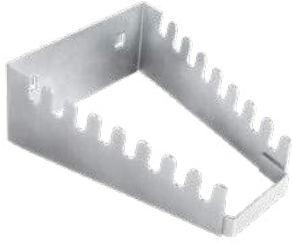

for
 84-500
 84-501

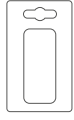

Ref.	Info	EAN
84-094	0/50	5907558439175

NEO
 TOOLS



for
 84-500
 84-501

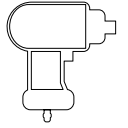

Ref.	Info	EAN
84-098	0/100	5907558442526

Modułowa szafka narzędziowa

Tool cabinet / Werkzeugschrank / Шкафчик для инструментов / Шафа інструментальна / Rakásolható műhelykocsi / Dulap pentru scule / Skříňka na nářadí / Skrinka na náradie / Omarica za orodje / Įrankių spintelė / Instrumentu skapis / Тööriistakapp / Шкафче за инструменти / Ormar za alate / Ormaric za alatke / Ντουλαπάκι για εργαλεία / Armario de almacenaje para herramientas / Carrello porta utensili / Estante p. Ferramentas / Rmoire à outils / Gereedschapskast

NEO
 TOOLS

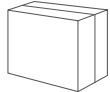

Ref.	Info	Info	EAN
84-226	59,9 x 37,8 x 59,9 cm	0/1	5907558425512

NEO
 TOOLS

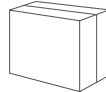

Ref.	Info	Info	EAN
84-227	3 szuflady / 3 drawers	0/2	5907558425529
84-228	2 szuflady / 2 drawers	0/2	5907558425536

System modułowy I

Modular system / Modulares System / Модульная система / Модульна система / Moduláris rendszer / Sistem modular / Modulární systém / Modulový systém / Modularni sistem / Moduline sistema / Modulu sistēma / Modulaarne süsteem / Модулна система / Modularni sustav / Модуларни систем / Αρθρωτό σύστημα / Sistema modular / Sistema modulare / Sistema modular / Système modulaire / Modulair systeem

NEO
 TOOLS

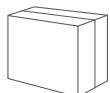

Ref.	Info	EAN
84-259	0/1	5907558431674

System modułowy I

Modular system / Modulares System / Модульная система / Модульна система / Moduláris rendszer / Sistem modular / Modulární systém / Modulový systém / Modularni sistem / Modulnè sistema / Modulu sistema / Modulaarne süsteem / Модулна система / Modularni sustav / Модуларни систем / Αρθρωτό σύστημα / Sistema modular / Sistema modulare / Sistema modular / Système modulaire / Modulair systeem

NEO
TOOLS



Ref. EAN
84-276 0/1 590755843608



Ref. EAN
84-277 0/1 5907558443615



Ref. EAN
84-278 0/1 5907558443622



Ref. EAN
84-266 0/1 5907558433968



Ref. EAN
84-257 0/1 5907558431650



Ref. EAN
84-256 0/1 5907558431643



Ref. EAN
84-255 0/1 5907558431636



Ref. EAN
84-269 0/1 5907558443592



Ref. EAN
84-267 0/1 5907558433975



Ref. EAN
84-350 0/1 5907558459708



Ref. EAN
84-286 1/1 5907558446470
84-287 1/120 5907558446487



Ref. EAN
84-268 0/1 5907558443585

System modułowy II

Modular system / Modulares System / Модульная система / Модульна система / Moduláris rendszer / Sistem modular / Modulární systém / Modulový systém / Modularni sistem / Modulnė sistema / Modulu sistēma / Modulaarne süsteem / Модулна система / Modularni sustav / Модуларни систем / Αρθρωτό σύστημα / Sistema modular / Sistema modulare / Sistema modular / Système modulaire / Modulair systeem

NEO
TOOLS



Ref.	☒	EAN
84-066	1/1	5907558450118



Ref.	☒	EAN
84-061	1/1	5907558450064



Ref.	☒	EAN
84-064	1/1	5907558450095



Ref.	☒	EAN
84-063	1/1	5907558450088



Ref.	☒	EAN
84-062	0/1	5907558450071



Ref.	☒	EAN
84-060	1/1	5907558450057



Ref.	☒	EAN
84-065	1/1	5907558450101

Warsztat mobilny

Mobile workshop / Werkzeugkasten / Мобильная мастерская / Скриня інструментальна / Szerszámkocsi / Cutie scule / Nářadová skříňka / Basa na náradie / Škatla za orodje / Įrankių dėžė / Instrumentu koferis / Tööriistakast / Купар за инструменти / Kutija za alat / Kutija za alat / Εργαλειοθήκη / Caja de herramientas / Carrello porta utensili / Caixa p. ferramentas / Caisse à outils / Gereedschapskist

NEO
TOOLS

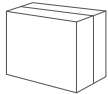
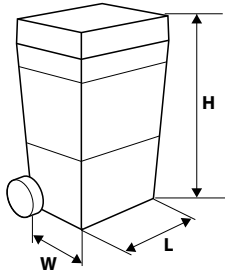

Ref.	L [mm]	W [mm]	H [mm]	☒	EAN
84-115	495	360	710	0/1	5907558421682

Skrzynka narzędziowa na kołach

Tool box with wheels / Werkzeugkasten / Ящик для инструмента с колесами / Скриня інструментальна / Szerszámkocsi / Cutie scule / Nářadová skříňka / Basa na náradie / Škatla za orodje / Įrankių dėžė / Instrumentu koferis / Tööriistakast / Купар за инструменти / Kutija za alat / Kutija za alat / Εργαλειοθήκη / Caja de herramientas / Carrello porta utensili / Caixa p. ferramentas / Caisse à outils / Gereedschapskist

NEO
TOOLS

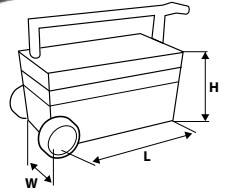

Ref.	L [mm]	W [mm]	H [mm]	☒	EAN
84-116	680	400	355	0/1	5907558421699

Skrzynka narzędziowa

Tool box / Werkzeugkasten / Ящик для инструмента / Скриня інструментальна / Szerszámkláda / Cutie scule / Nářadová skříňka / Basa na náradie / Škatla za orodje / Įrankių dėžė / Instrumentu koferis / Tööriistakast / Купар за инструменти / Kutija za alat / Kutija za alat / Εργαλειοθήκη / Caja de herramientas / Valigetta elettricista modulare / Caixa p. ferramentas / Caisse à outils / Gereedschapskist

NEO
TOOLS

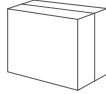

Ref.	☒	EAN
84-117	0/4	5907558425543

NEO
TOOLS

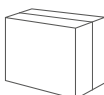
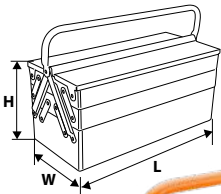

Ref.	L [mm]	W [mm]	H [mm]	m [kg]	☒	EAN
84-100	460	220	210	4,3	1/1	5907558409437
84-101	550	220	210	5	1/1	5907558409444

NEO
TOOLS

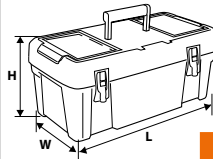

Ref.	L [mm]	W [mm]	H [mm]	☒	EAN
84-102	460	240	255	0/1	5907558409574
84-105	545	280	270	0/1	5907558408683

NEO
TOOLS

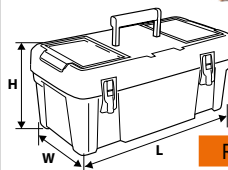

Ref.	L [mm]	W [mm]	H [mm]	☒	EAN
84-114	495	360	710	0/1	5907558439182

Skrzynka narzędziowa

Tool box / Werkzeugkasten / Ящик для инструмента / Скриня інструментальна / Szerszámláda / Cutie scule / Nářadová skříňka / Basa na náradie / Škatla za orodje / Įrankių dėžė / Instrumentu koferis / Tööriistakast / Купар за инструменти / Kutija za alat / Kutija za alat / Εργαλειοθήκη / Caja de herramientas / Valigetta elettrica modulare / Caixa p. ferramentas / Caisse à outils / Gereedschapskist

T TOPEX

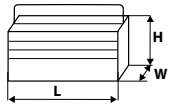

Ref.	L [cm]	W [cm]	H [cm]	Ⓜ [kg]	📦	EAN
79R100	40	20	21	3,4	0/1	5902062200396
79R101	55	20	21	4,4	0/1	5902062200402

T TOPEX

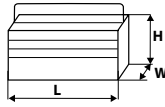

Ref.	L [cm]	W [cm]	H [cm]	Ⓜ [kg]	📦	EAN
79R102	55	20	27	5,5	0/1	5902062200419

T TOPEX

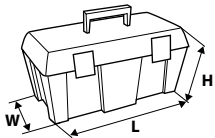

Ref.	["]	L [cm]	W [cm]	H [cm]	📦	EAN
79R129	25	60	29	33	0/1	5902062791290

T TOPEX

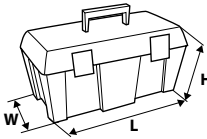

Ref.	["]	L [cm]	W [cm]	H [cm]	📦	EAN
79R120	12	29	14	15	0/1	5902062791207
79R121	16	38	17	17	0/1	5902062791214
79R122	18	44	22	22	0/1	5902062791221

T TOPEX

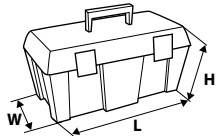

Ref.	["]	L [cm]	W [cm]	H [cm]	📦	EAN
79R123	12	29	14	15	0/1	5902062791238
79R124	16	38	17	17	0/1	5902062791245
79R125	18	44	22	22	0/1	5902062791252

T TOPEX

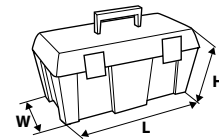

Ref.	L [cm]	W [cm]	H [cm]	📦	EAN
79R131	37,4	18,9	19,8	0/1	5902062997661

Walizka

Case / Koffer / Чемоданчик / Скриня/валіза / Szerszámostáska / Geantă / Kufřík / Kufřík / Kovček / Lagaminas / Čemodáns / Kohver / Купарче / Kofer / Kofer / Βαλιτάκι / Maletin / Casseta in alluminio / Mala / Valise / Koffer

T TOPEX

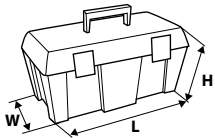

Ref.	L [cm]	W [cm]	H [cm]	📦	EAN
79R132	46,2	24,2	25,6	0/1	5902062997678
79R133	54,7	27,1	27,8	0/1	5902062997685

T TOPEX

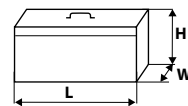

Ref.	L [cm]	W [cm]	H [cm]	Ⓜ [kg]	📦	EAN
79R220	45	15	32	2,4	0/4	5902062792204

Organizer

Organizer / Organizer / Организаёр / Организаёр / Szortimenter / Organizer / Organizér / Organizér plast. na spoj. materiál / Škatla za orodje / Systeineris / Sikumkaste / Säilituskast / Организаёр / Kutija za alat / Kutija za alat / Organizer / Organizador / Organiser / Agenda / Organiseur / Organizer



12 wymiowych pojemników
12 removable containers
12 съёмные контейнеры



Antyustrząsowe narożniki
Anti-shake corners
Антивибрационные углы



Poliwęglanowa pokrywa
Polycarbonate cover
Поликарбонатная крышка



Aluminiowe zapięcie
Aluminum clasp
Алюминиевая застёжка

NEO
TOOLS

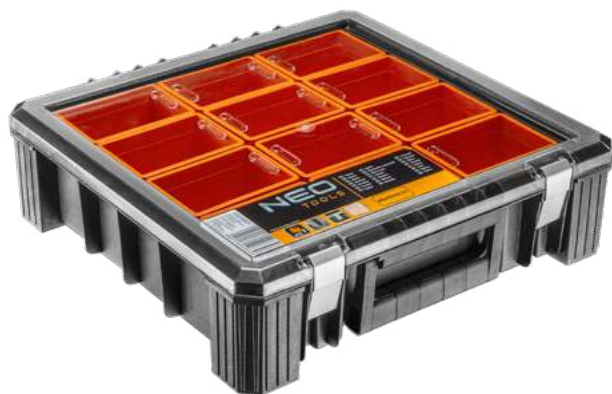

Ref.	info	📦	EAN
84-130	40 x 40 x 12 cm	0/1	5907558431216



8 wymiowych pojemników
8 removable containers
8 съёмные контейнеры

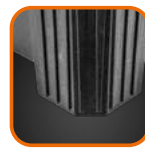

Antyustrząsowe narożniki
Anti-shake corners
Антивибрационные углы



Poliwęglanowa pokrywa
Polycarbonate cover
Поликарбонатная крышка



Aluminiowe zapięcie
Aluminum clasp
Алюминиевая застёжка

NEO
TOOLS



Regulowane przegrody
Adjustable dividers
Регулируемые отсеки



Ref.	info	📦	EAN
84-131	39 x 60 x 11 cm	0/1	5907558431223

NEO
TOOLS

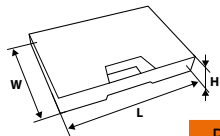

Ref.	L [mm]	W [mm]	H [mm]	📦	EAN
84-118	390	290	65	0/1	5907558439229
84-119	490	390	65	0/1	5907558439236

TOPEX

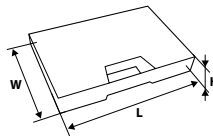

Ref.	L [cm]	W [cm]	H [cm]	📦	EAN
79R160	46	33	11	0/1	5902062791603

TOPEX



Ref.	L [cm]	W [cm]	H [cm]	📦	EAN
79R163	36	25	5,5	0/1	5902062791634

TOPEX

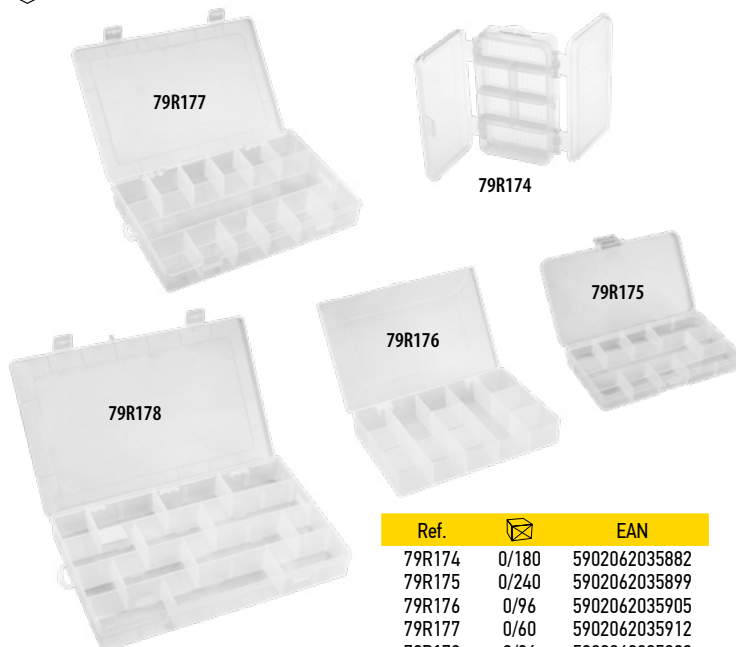

Ref.	📦	EAN
79R174	0/180	5902062035882
79R175	0/240	5902062035899
79R176	0/96	5902062035905
79R177	0/60	5902062035912
79R178	0/36	5902062035929

Plecak monterski

Tool backpack / Monteurrucksack / Рюкзак монтерский / Рюкзак монтерський / Szerszámás hátizsák / Rucsac pentru mecanic / Batoh na náradí / Plecniak na náradie / Nahrtnik za orodje / Montuotojo jrankiū kuprinė / Instrumentu mugursoma / Tööriistade seljakott / Монтьорска раница / Rusak za montere / Monterski ranac / Σάκος εργαλείων / Mochila de montador / Zaino porta utensili / Mochila para ferramentas / Sac à dos porte-outils / Monteur rugzak

NEO
TOOLS



Ref. EAN
84-304 0/6 5907558425833

Plecak monterski na kołach

Tool backpack with wheels / Monteurrucksack mit Rädern / Рюкзак монтерский на колесах / Рюкзак монтерський на коліщатах / Szerszámás hátizsák / Rucsac pe roți pentru mecanic / Batoh na náradí na kolečkách / Plecniak na náradie na kolieskach / Nahrtnik za orodje na kolesih / Montuotojo jrankiū kuprinė su ratukais / Instrumentu mugursoma uz ritepiem / Tööriistade seljakott, ratastega / Монтьорска раница на кола / Rusak za montere s kotačima / Monterski ranac sa točkicama / Σάκος εργαλείων με ρόδες / Mochila de montador sobre ruedas / Trolley/zaino in tela / Mochila para ferramentas com rodas / Sac à dos porte-outils à roulettes / Monteur rugzak op wielen

NEO
TOOLS



Ref. EAN
84-303 0/2 5907558425826

Torba monterska

Tool bag / Monteurtasche / Сумка монтерская / Торба інструментальна / Szerszámtáska csődalakú fém fogantyúval / Geanta scule / Monterská brašna / Taška monterska kožená / Torba za orodje / Monterio krepšys / Instrumentu soma / Tööriistakott / Нуфар за инструменти / Torba za alat / Torba za alat / Σάκος για εργαλεία / Bolsa para herramientas / Borsa per meccanico / Saco p. montagem / Sac de monteur / Montagetas

NEO
TOOLS



Ref. EAN
84-301 0/2 5907558425802

NEO
TOOLS



Ref. EAN
84-308 0/4 5907558427745

NEO
TOOLS



20"

NYLON
600D

Ref. EAN
84-300 0/4 5907558417258

NEO
TOOLS



NYLON
600D

Ref. EAN
84-305 0/6 5907558417265

Torba monterska

Tool bag / Monteurtasche / Сумка монтерская / Торба інструментальна / Szerszámtáska csőalakú fém fogantyúval / Geanta scule / Montérská brašna / Taška montérska kožená / Torba za orodje / Monterio krepšys / Instrumentu soma / Tööriistakott / Кудар за инструменти / Torba za alat / Torba za alat / Σάκος για εργαλεία / Bolsa para herramientas / Borsa per meccanico / Saco p. montagem / Sac de monteur / Montagetas

NEO
TOOLS



Ref.	☒	EAN
84-315	0/35	5907558428391

TOPEX

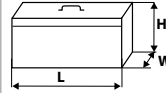

Ref.	L [cm]	W [cm]	H [cm]	☒ [kg]	☒	EAN
79R200	41	14	25	1,8	0/1	5902062200457

TOPEX

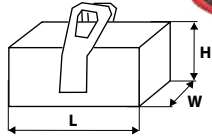

Ref.	L [cm]	W [cm]	H [cm]	☒	EAN
79R440	41	23	23	0/4	5902062794406

TOPEX

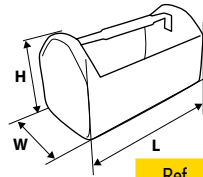

Ref.	L [cm]	W [cm]	H [cm]	☒	EAN
79R444	42	22	24	0/4	5902062794444

TOPEX

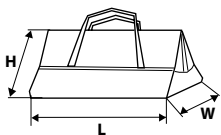

Ref.	L [cm]	W [cm]	H [cm]	☒	EAN
79R441	46	30	33	0/12	5902062794413

TOPEX

**HEAVY
DUTY**



Ref.	☒	EAN
79R204	0/60	5902062036797

Torba monterska na kołach

Tool bag with wheels / Monteurtasche / Монтерская сумка на колесах / Торба монтерська на коліщатах / Szerszámtáska / Geantă pe roți pentru mecanic. / Taška na nářadí na kolečkách / Taška na nářadí na kolieskach / Torba za orodje na kolesih / Montuotojo krepšys su ratukais / Instrumentu soma uz ritepiem / Tööriistakott, ratastega / Монтьорска торба на колена / Torba za montere s kotačima / Monterska torba sa točkicama / Ταύτα εργαλείων με ρόδες / Bolsa de montador sobre ruedas / Trolley in tela / Bolsa para ferramentas com rodas / Sac porte-outils à roulettes / Monteurstas op wielen

NEO
TOOLS



TOPEX



Ref.	📦	EAN
84-302	0/2	5907558425819



Ref.	📦	EAN
79R449	0/5	5902062034151

Stołek z torbą monterską

Chair with tool bag / Sitz mit Monteurtasche / Табурет складной с монтерской сумкой / Столик із монтерською торбою / Szerszámtáska szék funkcióval / Scăunaș cu geantă pentru mecanic / Skládací židle s taškou na nářadí / Stolik s taškou na nářadí / Mizica s torbo za orodje / Staliukas su montuotojo krepšiu / Taburete ar instrumentu somu / Tööriistakotiga laud / Табуретка с моньорска торба / Stolica s torbom za montere / Stolica sa monterskom torbom / Πτυσσόμενο ακαθνμάκι με ταύτα εργαλείων / Silla con bolsa de montador / Seggiolino pieghevole con borsa / Banco com bolsa para ferramentas / Sac à outils avec siège pliant / Kruk met monteurstas

NEO
TOOLS



TOPEX

HEAVY DUTY



Ref.	📦	EAN
84-306	0/10	5907558425796



Ref.	📦	EAN
79R447	0/10	5902062034137

Saszetka

Waist bag / Gürteltasche / Поясная сумка / Торба на паску / Övtáska / Borseta / Ledvinka / Ladvinka / Pasma torbica / Déklas / Jostas soma / Vöökott / Паласка / Pasma torbica / Torbica / Τασάκι μέσης / Riñonera / Marsupio porta utensili / Bolsa / Sacoche porte-outils à ceinture

NEO
TOOLS



Ref.	📦	EAN
84-311	0/70	5907558428377

Kamizelka monterska

Tool jacket / Monteurstas / Жилет монтажника / Жилетка з кишенями для інструмента / Szerszámtartó mellény / Îneliș protecție pentru unelte / Montérská vesta / Vesta montérská / Jakna za orodje / Monterio liemenë / Montiera veste / Tööriistavest / Елек монтьорска / Prsluk za alat / Torba za alat / Σακάκι τεχνική / Chaleco portaherramientas / Gilet portoutensili / Colete para montagem / Gilet de monteur / Gereedschapsvest

TOPEX



Narzędzia nie są dołączone
Tools are not included
Продається без інструмента

Ref.	📦	EAN
79R255	0/30	5902062792556

Kieszonka na narzędzia

Tool pocket / Werkzeugtasche / Сумка для инструментов / Карман для инструмента / Szög és szerszámtartó / Buzunar pentru scule / Kapsa na nářadí / Vrecko na nářadí / Žep za orodja / Deklas įrankiams / Instrumentu somiņa / Тööriistatasku / Преградка за инструментти / Futrola za alate / Džep za alat / Τοάντα εργαλείων / Portaherramientas / Marsupio porta utensili / Bolso p. ferramentas / Poche à outils / Gereedschapszak

NEO
TOOLS



x4

PVC
1680D

400
g/m²

Ref. 84-333 EAN 0/50 5907558415698

NEO
TOOLS



x8

PVC
1680D

400
g/m²

Ref. 84-334 EAN 20/40 5907558415704

TOPEX

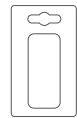

Narzędzia nie są dołączone
Tools are not included
Продается без инструмента

Ref. 79R431 EAN 0/50 5902062794314

TOPEX

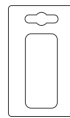

Narzędzia nie są dołączone
Tools are not included
Продается без инструмента

Ref. 79R432 EAN 0/40 5902062794321

TOPEX

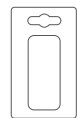

Narzędzia nie są dołączone
Tools are not included
Продается без инструмента

Ref. 79R430 EAN 0/50 5902062794307

TOPEX

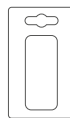

Narzędzia nie są dołączone
Tools are not included
Продается без инструмента

Ref. 79R421 EAN 0/100 5902062794215

Kabura

Holster / Halfter / Кобура / Кобура / Szerszámtartó övtáska / Carcasa / Kožené pouzdro / Púzdro na vřtačku / Torbica za orodje / Deklas / Instrumentu josta / Kabuur / Кальф за бормашина / Torbica za bušilicu / Torbica za alat / Πιστολιθήκη / Pistolera para herramientas eléctricas / Fondina per elettrotensili / Estajo / Gaine / Holster

TOPEX

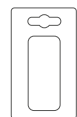

Narzędzia nie są dołączone
Tools are not included
Продается без инструмента

Ref. 79R415 EAN 0/12 485902062794154

TOPEX

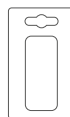

Narzędzia nie są dołączone
Tools are not included
Продается без инструмента

Ref. 79R416 EAN 0/100 5902062794161

Materiałowe etui na narzędzia

Textile tool case / Werkzeugkoffer aus Stoff / Текстильные чехлы для инструментов / Текстильні чохли для інструментів / Textil szerszámartó / Husă textilă pentru scule / Materiálové pouzdro na náradí / Materiálové pouzdro na náradie / Etui iz blaga za orodje / Medžaginis įrankių dėklas / Auduma arvalki instrumentiem / Kangast tööriistavutlar / Платнен налф за инструменти / Etui za alat / Kutije za alat / Υφασμάτινη θήκη εργαλείων / Estuche textil para las herramientas / Valigetta per utensili in tessuto / Estujo téxtil para as ferramentas / Trousse rangement des outils en tissu / Stoffen gereedschapsetui

NEO
TOOLS



22
POUCHES

UNIVERSAL

Ref. 09-890 0/40 EAN 5907558458923

Stolek składany

Foldable stool / zusammenklappbarer Hocker / Табурет складной / Стільчик складаний / Összesukható sámlí / Taburet pliant / Skládací stolička / Skladací stolček / Zložljiva pručka / Sulankstoma kėdutė / Saliekamgalds / Kokkuradav laud / Съваема масичка / Sklopiva stolica / Stolic na rasklapanje / Πτυσσόμενο ακαμνάκι / Banco plegable / Tavolino pieghevole / Banco dobrável / Escabeau / Kantelbare kruk

TOPEX



22
cm

150
kg

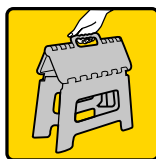

Ref. 79R319 0/12 EAN 5902062793188

Perforacja narzędziowa

Tool wall / Werkzeuglochung / Панель перфорированная для инструментов / Панель інструментальна / Szerszámossal / Suport perete pentru unelte / Perforace pro uchycení držáků náradí / Panel na náradie / Stenski regal / Sienele įrankiams / Instrumentu plaukts / Tööriistaalus / Перфорация на инструменти / Perforirani organizer za alate / Polica za alat / Τοίχος για εργαλεία / Tablero organizador para herramientas / Perforazione per attrezzi / Perfuração de ferramentas / Plaques perforées pour outils / Gereedschapswand

NEO
TOOLS

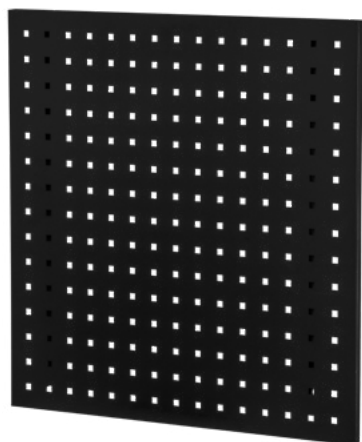

60 cm
60 cm
2 cm

steel
thickness
0.8
mm

steel
cold
SPCC

includes
WALL
PLUGS

Ref. 84-500 H [mm] 600 W [mm] 600 D [mm] 20 0/1 EAN 5907558454253

NEO
TOOLS

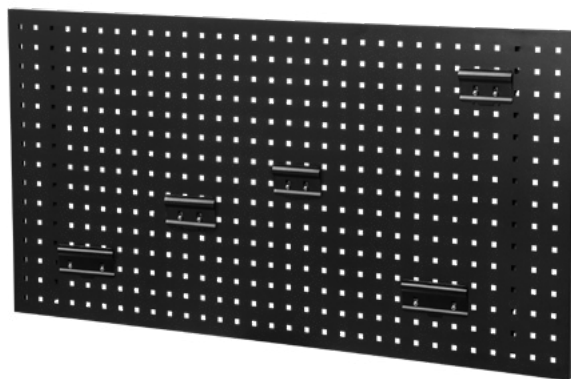

120 cm
60 cm
2 cm

steel
thickness
0.8
mm

steel
cold
SPCC

includes
WALL
PLUGS

Ref. 84-501 H [mm] 600 W [mm] 1200 D [mm] 20 0/1 EAN 5907558454260

Hak na pojemnik

Hooks / Hacken / Крюки / Гаки / Horgok / Cârlițe / Háký / Skoby / Kļjuke / Kabliai / Āķi / Haagid / Кукы / Kuke / Кукe / Γάντζοι / Ganchos / Ganci / Anzóis / Crochets / Haken

NEO
TOOLS



steel
cold
SPCC

steel
thickness
1.0
mm

10x6
cm

Ref. 84-502 250/250 EAN 5907558454277

NEO
TOOLS



steel
cold
SPCC

steel
thickness
1.0
mm

13x6.5
cm

Ref. 84-503 250/250 EAN 5907558454284

Listwy magnetyczne

Magnetic tool holders / Magnetische Werkzeughalter / Держатели магнитных инструментов / Магнітні тримачі інструментів / Mágneses szerszámartók / Suporturi de scule magnetice / Magnetické držáky nástrojů / Magnetické držáky nástrojov / Magnetna držala za orodje / Magnetinių įrankių laikikliai / Magnētisko instrumentu turētāji / Magnetiliste tööriistade hoidjad / Магнитни държачи за инструменти / Magnetski držači alata / Magneti držači alata / Μαγνητικά εργαλεία στήριξης / Portaherramientas magnéticas / Portautensili magnetici / Porta-ferramentas magnéticas / Porte-outils magnétiques / Magnetische gereedschapshouders

NEO
TOOLS

x3



Ref. 84-144 6/12 EAN 5907558449006

plyta warsztatowa z pojemnikami

Workshop panel / Werkstattplatte / Панель для мастерской / Панель инструментальна / Szerszámartató fal / Placã atelier / Dílenská deska / Dielenská doska / Stenska plošča za orodje / Sienelë irankiams kabinti / Darbnīcas plāksne / Riputusplaat töökoja seinale / Панел за инструменти / Radionička ploča / Radionička ploča za kačenje / Πάνελ για εργαλεία / Placa de taller / Parete di supporto con vaschetta porta oggetti / Tableau porte-outils / Placa de suspensão de caixas organizadoras / Werkplaats zaag

TOPEX



Ref.	☒	EAN
79R170	1/26	5902062035844

Listwa plastikowa do pojemników

Bar / Leiste / Планна / Планка / Rúd szerszámartatóládákhoz / Šipčã / Lišta / Lišta / Letev / Pločštelë tvirtinimui / Liste / Riputuslist / Λαϊσνα / Radionička letva / Letva za kačenje / Σαβίβα / Listón / Barra di supporto / Latte / Barra de suspensão / Lijst

TOPEX



Ref.	☒	EAN
79R172	0/100	5902062035868

Pojemnik magazynowy

Store container / Magazinbehälter / Складской контейнер / Контейнер / Alkatrésztartó láda / Recipient de deposit / Skladovací boxy / Skladovacia nádoba / Predalnik / Skyrelio dėžutė / Noliiktavu konteineris / Hoiutamuti / Машинен контейнер / Spremnik za skladište / Kontejner za skladištenje / Δοχείο αποθήκευσης / Cubeta de almacenaje / Contenitore impilabile / Recipiente de armazém / Réceptient de magasin / Opslagcontainer

TOPEX

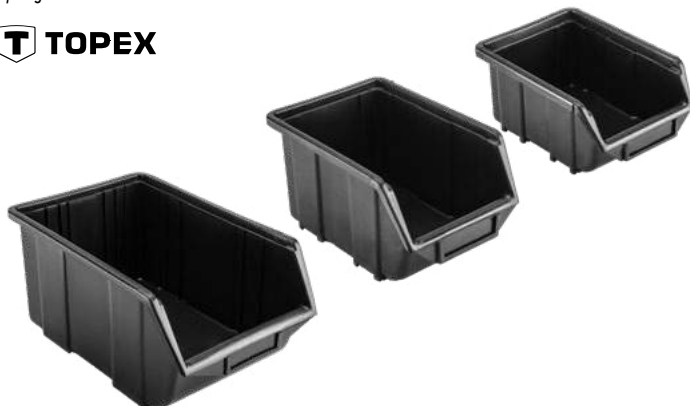

Ref.	L [cm]	W [cm]	H [cm]	☒	EAN
79R182	17	11,5	7,5	0/1	5902062791825
79R183	25	16	13	0/1	5902062791832
79R184	36	22,5	16,5	0/1	5902062791849

TOPEX

79R167

79R168

79R169

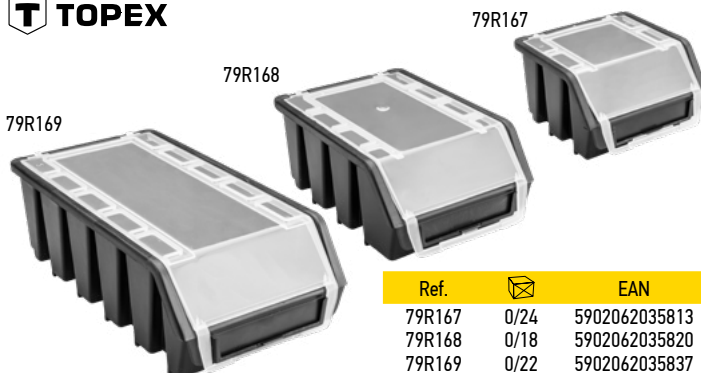

Ref.	☒	EAN
79R167	0/24	5902062035813
79R168	0/18	5902062035820
79R169	0/22	5902062035837

TOPEX



Ref.	☒	EAN
79R171	1/20	5902062035851

Płyta warsztatowa do pojemników

Workshop panel / Werkstattplatte / Панель для мастерской / Панель инструментальна / Hátfal szerszámartatóládákhoz / Placã atelier / Dílenská deska / Dielenská doska / Stenska plošča za orodje / Sienelë irankiams kabinti / Darbnīcas plāksne / Riputusplaat töökoja seinale / Панел за инструменти / Radionička ploča / Radionička ploča za kačenje / Πάνελ για εργαλεία / Placa de taller / Parete di supporto con vaschetta porta oggetti / Tableau porte-outils / Placa de suspensão de caixas organizadoras / Werkplaats zaag

TOPEX



Ref.	☒	EAN
79R173	0/20	5902062035875

Perforacja narzędziowa

Tool wall / Werkzeuglochung / Панель перфорированная для инструментов / Панель инструментальна / Szerszámartató fal / Scule perete / Perforace pro uchycení držáků nářadí / Panel na náradie / Stenski regal / Sienelë irankiams / Instrumentu plaukts / Tööriistalaus / Перфорация на инструменти / Perforirani organizer za alate / Polica za alat / Τοίχος για εργαλεία / Tablero organizador para herramientas / Tavola organiser per utensili / Perfuração de ferramentas / Plaques perforées pour outils / Gereedschapswand

TOPEX

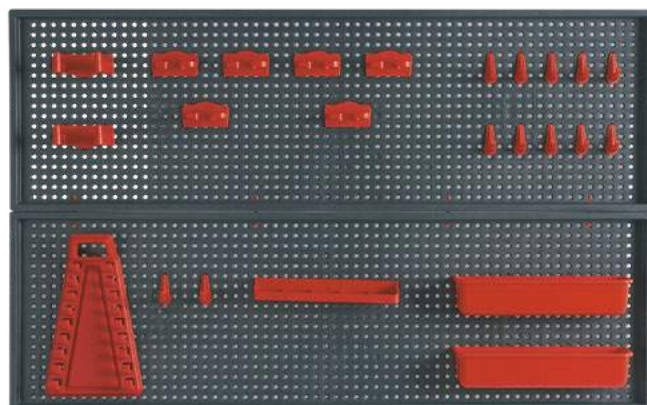

Ref.	L [cm]	H [cm]	☒	EAN
79R186	80	50	0/9	5902062791863

Haki
 Hooks / Hacken / Крюки / Гаки / Horgok / Cârțige / Háky / Skoby / Kljčke / Kabliai / Āķi / Haagid / Кукы / Kuke / Kuke / Γάντζοι / Ganchos / Ganci / Anzóis / Crochets / Haken

NEO
 TOOLS

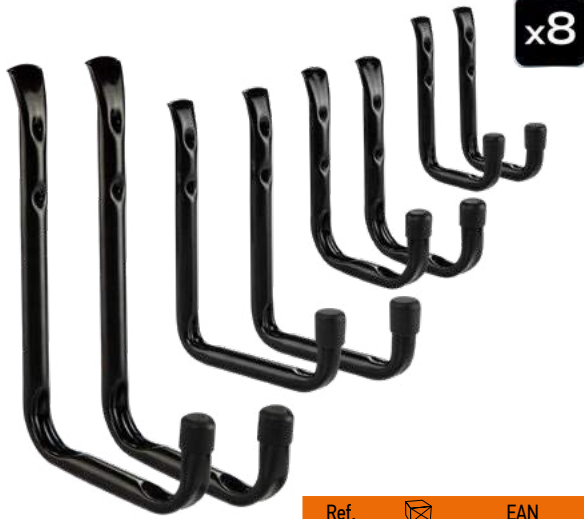

Ref. EAN
 84-142 6/12 5907558448984

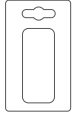

NEO
 TOOLS

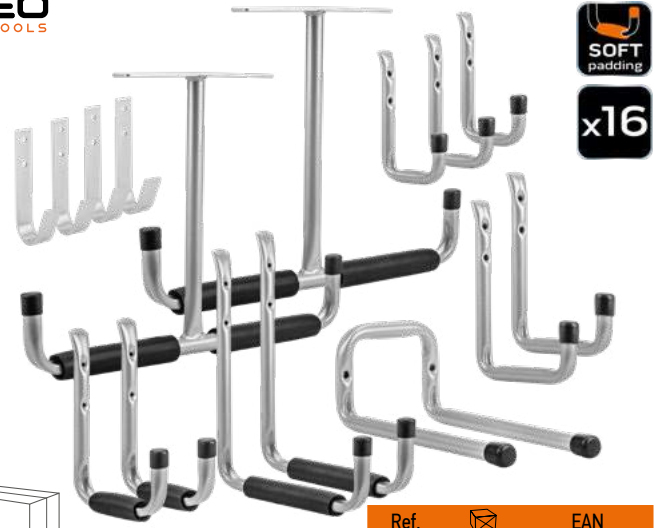

Ref. EAN
 84-143 6/12 5907558448993

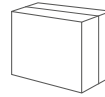

Wózek transportowy

Multipurpose trolley / Transportwagen / Тележка грузозная / Візок транспортувальний / Molnárkocsi / Cărucior de transport / Prepravni vozik / Prepravny vozik / Transportni vozíček / Maišelis transportavimui / Ratiji / Veokäru / Транспортна колица / Transportna kolica / Transportna kolica / Καρότσια μεταφοράς / Carretilla de transporte / Carrello di trasporto / Carrinho de transporte / Chariot de manutention / Transportwagen

NEO
 TOOLS



Ref. EAN
 84-400 0/6 5907558431605

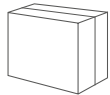

NEO
 TOOLS



Ref. EAN
 84-402 0/1 5907558431612

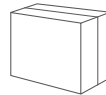

NEO
 TOOLS



Ref. EAN
 84-401 0/1 5907558431605

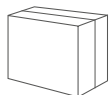

NEO
 TOOLS



Ref. EAN
 84-403 0/1 5907558431629

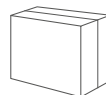

Wózek transportowy

Multipurpose trolley / Transportwagen / Тележка грузозная / Візок транспортувальний / Molnárkocsi / Čárucior de transport / Přepravní vozík / Prepravný vozík / Transportni vozíček / Maišelis transportavimui / Ratiņi / Veokäru / Транспортна количка / Transportna kolica / Transportna kolica / Καρότσι μεταφοράς / Carretilla de transporte / Carrello di trasporto / Carrinho de transporte / Chariot de manutention / Transportwagen

TOPEX

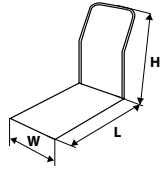

ALUMINIUM

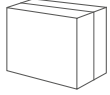

Ref.	L [cm]	W [cm]	H [cm]	max [kg]	[kg]	☒	EAN
79R300	50/70	42	65	150	7,5	0/1	5902062207746

TOPEX

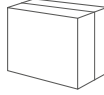
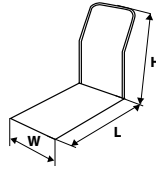

Ref.	L [cm]	W [cm]	H [cm]	max [kg]	[kg]	☒	EAN
79R301	72	47	82	150	8,9	0/1	5902062793010

TOPEX



215mm

120 kg

350x185 mm

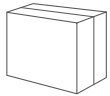

Ref.	L [cm]	W [cm]	max [kg]	[kg]	☒	EAN
79R305	35	18,5	120	5,4	0/1	5902062042248

TOPEX

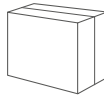

Ref.	L [cm]	W [cm]	max [kg]	[kg]	☒	EAN
79R302	43	42	90	4,8	0/1	5902062810106

TOPEX

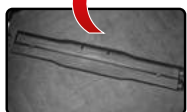

35 kg

LIGHT

Ref.	max [kg]	[kg]	☒	EAN
79R306	35	2,75	0/6	5902062042255

Platforma transportowa

Transport platform / Транспортная платформа / Platforma de transport / Anyagmozgató kocsi / транспортна платформа / Dopravná plošina / Transportní plošina / Transportplattform / Transportna platforma / Transporto platforma / Transporta platforma / Transportdiplavorm / Транспортна платформа / Transportna platforma / Транспортна платформа / Πλατφόρμα μεταφοράς / Plataforma de transporte / Piattaforma di trasporto / Plataforma de transporte / Plateforme de transport / Transportplattform

NEO
TOOLS

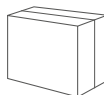

Ref.	capacity [kg]	☒	EAN
84-141	200	0/6	5907558448979

Taśma do bagażu

Luggage strap / Geräckband / Лента для багажа / Стрічка багажна / Rakományrögzítő / Bandă de bagaje / Popruh na zavazadla / Pás na náklady / Trak za prtljago / Krovinių tvirtinimo juosta / Bagāžas lente / Koormarihmad / Лента за багаж / Traka za prtljagu / Traka za prtljag / Ταβία αποσκευών / Cinta para maleta / Cinghie con cricchetto / Fita p. Bagagem / Bande à bagage / Bagageband

NEO
TOOLS



Ref.	daN.	L [m]	W [mm]	☒	EAN
84-140	250 / 500	5	50	0/10	5907558448962

TOPEX



Ref.	L [m]	W [mm]	x N	☒ [kg]	☒	EAN
97X185	7,0	50	1	1,6	0/10	5902062971852
97X186	4,5	30	2	1,7	0/10	5902062971869

TOPEX



Ref.	L [m]	W [mm]	☒	EAN
97X183	2,5	25	0/80	5902062971838
97X184	5,0	25	0/50	5902062971845

TOP TOOLS



Ref.	L [m]	W [mm]	☒	EAN
97X192	6	50	0/24	5902062992000

TOP TOOLS



Ref.	L [m]	W [mm]	☒	EAN
97X195	5	25	0/36	5902062171344

Ściągacze do bagażu

Luggage tie down straps / Geräckbefestigung / Зажимные болты для багажа / Багажни паси зумови / Csomagrögzítő / Dispozitiv de scosbagaje / Stahovací pásy na zavazadla / Uprnicie lano "panůk" / Elastične vrvi / Krovinių tvirtinimo spaustuvi / bagāžas saspieđējskrūves / Koormatõmmitad / Ремьци за багаж / skidači prtljage / Skidači za prtljag / Ιμάντες ασφάλισης αποσκευών / Correas elásticas para maletas / Cinghie elastiche per bagagli / Ponta de aperto de bagagem / Sangles de bagage / Trekkers voor bagage

TOP TOOLS

x12

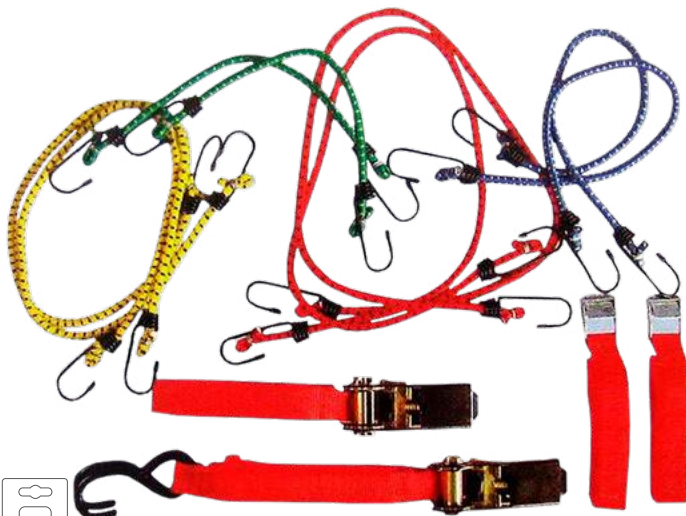

Ref.	☒	EAN
97X206	0/12	5902062972064

TOP TOOLS

x2



Ref.	L [cm]	☒	EAN
97X198	80	72/144	5902062170170
97X199	100	40/120	5902062170187

Ośłona przewodów

Cable tube / Kabelabdeckung / Οργαναίσερ для проводов / Кабель-канал / Kábel csatorna / Aprtoare de cabluri / Trubice pro vedení kabelů / Kryt na káble / Pokrivalo za kabel / Kabelių apsauga / Kabelu aizsegs / Juhtmekate / Спирала бандажна за кабелен сноп / Fleksibilna zaštita kablova / Zaštita za kabl / Σπιράλ οργάνωσης καλωδίων / Espiral para cables / Tubo per cavo / Protecção de cabos / Protection range-câbles

TOPEX



Ref.	L [mm]	Ø [mm]	☒	EAN
79R273	200	20	0/50	5902062004567
79R274	200	25	0/40	5902062004574
79R275	200	30	0/30	5902062004581

Plandeka

Taraulin / Plane / Брезентовая покрывка / Тент брезентовый / Takarórpunya / Prelatä / Plachta / Plachta zakrývacia / Cerada / Brezentas / Pärvalks / Present / Брезентово покрывало / Cerada / Cerada / Μουσαμάς / Lona / Telone impermeabile / Lona / Bâche / Doek

TOPEX



PE

70
[g/m²]

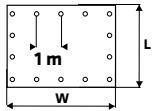

Ref.	L [m]	W [m]	☒	EAN
79R355	3	4	0/20	5902062793553
79R356	4	6	0/10	5902062793560
79R357	5	8	0/6	5902062793577

TOPEX



PE

85
[g/m²]



Ref.	L [m]	W [m]	☒	EAN
79R363	4	6	0/10	5902062793638
79R364	5	8	0/6	5902062793645
79R365	6	10	0/4	5902062793652
79R367	10	15	0/1	5902062793676

TOP TOOLS



60
g/m²

PE

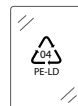

Ref.	L [m]	W [m]	☒	EAN
79R351	3	4	0/20	5902062793515
79R352	4	6	0/10	5902062793522

Worki na odpady, mocne

Strong waste bags / Beutel für Abfall, fest / Мешки для отходов, прочные / Мішки для відходів, міцні / Szemetesszak / Sacji p/t reziduri, rezistente / Pytle na odpad, silné / Vrečia na odpad, pevné / Vreče za odpad, močne / Šiuokščių maišai, stiprūs / Atkritumu maiši, izturīgi / Jäätmekotid, tugevad / Чуьвали за отпадьци, силни / Vreče za odpad, čvrste / Kесе за отпад, јаке / Σάκοι αποβλήτων ανθεκτικοί / Bolsas de residuos, resistentes / Sacchi per rifiuti / Sacos para residuos, fortes / Sacs pour ordures, résistants, / Afvalzakken, sterk

TOPEX



x10

SUPER STRONG

Ref.	Q [l]	[µm]	☒	EAN
23B258	120	40	0/30	5902062009012
23B259	240	45	0/10	5902062009029

Kluczyk uniwersalny do szafek

Universal control cabinet key / Universalschlüssel für Schränke / Ключ универсальный для шкафов / Ключ универсальный до шаф / Chiave universale per armadietti / Cheie univesala pentru dulapuri / Univerzální klíč na rozvodné skříně / Univerzálny kľúčik na skrinky / Univerzalni ključ za električne omarice / Elektros spintelių raktas, universalus / Univeršāla atslēga skapjiem / Univerzaalne karinõti / Универсален ключ за шкафчета / Univerzalni ključ za ormare / Univerzalni ključ / Κλειδιά γενικής χρήσης για ντουλάπια εργασίας / Llave universal para armarios / Chiave universale per armadietti / Chave universal para armários / Clé pour armoires universelle

NEO TOOLS



Ref.	☒	EAN
02-001	50/200	5907558404319

NEO TOOLS

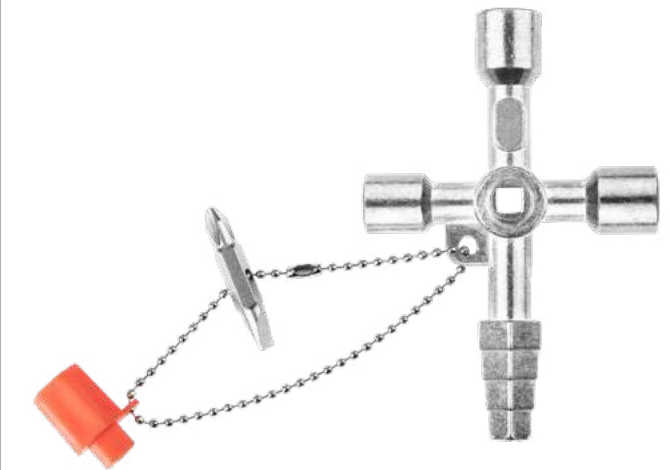

Ref.	☒	EAN
01-402	24/192	5907558449631

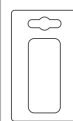



ŁĄCZENIE
JOINING & СОЕДИНИТЕЛЬНЫЕ



Zszywacz

Stapler / Heftmaschine / Cmennep / Cmennep / Tűzőgép / Capsator / Sešivačka / Spunkovačka / Spenjač / Kabiamašis / Skavu pistole / Klammerdaja / Takep / Klamera / Heftalica / Μηχανή συρραφής / Grapadora / Cucitrice / Máquina de pontear / Agrafeuse / Hechtmaschine

NEO
TOOLS



Ref. EAN
16-032 6/24 5907558454703

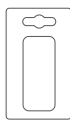

NEO
TOOLS



Ref. EAN
16-030 6/12 5907558454680

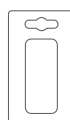

NEO
TOOLS



Ref. EAN
16-033 6/24 5907558454710

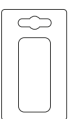

NEO
TOOLS



Ref. EAN
16-031 6/24 5907558454697

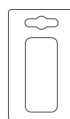

T TOPEX

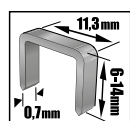

typ J



Ref. EAN
41E906 20/40 5902062031594

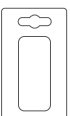

T TOPEX

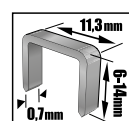

typ J



Ref. EAN
41E905 20/40 5902062030634

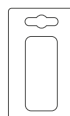

T TOPEX

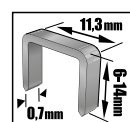

typ J



Ref. EAN
41E903 20/40 5902062030580

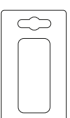

T TOPEX

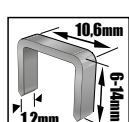

typ G



Ref. EAN
41E908 20/40 5902062419088

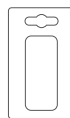

Zszywacz

Stapler / Heftmaschine / Сменлер / Сменлер / Túzógép / Capsator / Sešivačka / Sponkovačka / Spenjač / Kabiamašis / Skavu pistole / Klammerdaja / Такер / Klamerica / Heftalica / Μηχανή συρραφής / Grapadora / Cucitrice / Máquina de pontear / Agrafeuse / Hechtmaschine

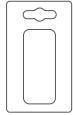

Ref.	Type J	☒	EAN
41E904	4 - 14 mm	10/40	5902062031228

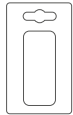

Ref.	Type J	☒	EAN
41E901	4 - 8 mm	15/60	5902062030016

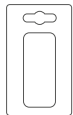

Ref.	Type J	☒	EAN
41E915	4 - 8 mm	5/15	5902062021069

Rozszywacz

Staple remover / Klammerentferner / Антисменлер / Засіб для видалення сноб / Túzó eltávolító / Remover de capse / Odstraňovač sponiek / Odstraňovač sponiek / Odstranjivalec sponk / Susegimo vališkis / Skavu porēšanas līdzeklis / Klambrite eemaldaja / Антисменлоб / Alat za uklanjaње spajalica / Уклањање снајамлица / Αφαιρέση συνβητρών / Quitagrapas / Levapunti / Removedor de grampos / Dégrafeur / Ontnieter /

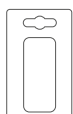

Ref.	☒	EAN
16-040	10/80	5907558454734

Zszywacz młotkowy

Hammer stapler / Hammerhefter / Сменлер молотковый / Молоток сменлер / Kalapács tűzó / Capsator cu ciocan / Sešivačka kladiva / Sešivačka kladiva / Spenjalnik kladiva / Plaktuko segiklis / Āmura skavotājs / Klambripūstol haamri / Телбод с чук / Hemer klamerica / Cekić heftalica / Συρραπτικό σφυρί / Grapadora de martillo / Cucitrice a martello / Grampeador de martelo / Agrafeuse à marteau / Hamer nietmachine

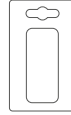

Ref.	☒	EAN
16-034	6/24	5907558454727

Zszywki

Staples / Klammern / Снобы / Снобу / Túzókapocs / Capsator / Sešivací spony / Sponky / Sponke / Kabės / Skavas / Klambrič / Телъема / Municija za klamericu / Heftalica / Συρραπίδες / Grapas / Puntis metallici / Pontas / Agrafes / Hechters

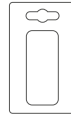
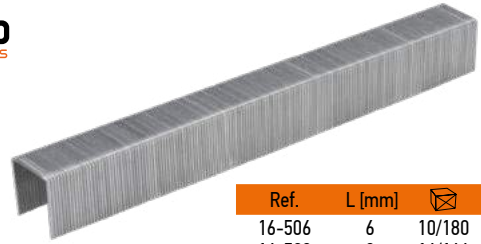

Ref.	L [mm]	☒	EAN
16-506	6	10/180	5907558401493
16-508	8	16/144	5907558401509
16-510	10	20/180	5907558401516
16-512	12	20/90	5907558401523
16-514	14	10/90	5907558401530

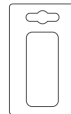
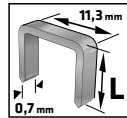

Ref.	L [mm]	N	☒	EAN
41E306	6	x1000	20/200	5902062030436
41E308	8	x1000	20/200	5902062030443
41E310	10	x1000	20/200	5902062202499
41E312	12	x1000	20/200	5902062202772
41E314	14	x1000	20/200	5902062202505

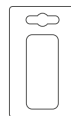
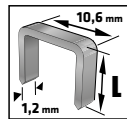

Ref.	L [mm]	N	☒	EAN
41E406	6	x1000	0/200	5902062414069
41E408	8	x1000	0/100	5902062414083
41E410	10	x1000	0/100	5902062414106
41E412	12	x1000	0/100	5902062414120
41E414	14	x1000	0/100	5902062414144

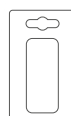

Ref.	Type	L [mm]	N	☒	EAN
41E006	J	6	x1000	50/300	5902062031310
41E008	J	8	x1000	50/200	5902062031327
41E010	J	10	x1000	45/180	5902062031334
41E012	J	12	x1000	30/180	5902062031341
41E014	J	14	x1000	30/150	5902062031358

Pistolet klejowy

Glue gun / Leimpistole / Пистолет клеєвий / Пистолет клеїючий / Ragasztópisztoly / Pistol de lipit / Lepící pistole / Pištol lepiaca / Lepilna pištola / Ključ pistoletas / Limes pistole / Liimpistol / Пистолет за силикон / Pištolj za plastiku / Pistol za plastiku / Πιστόλι θερμοκόλλησης / Pistola surtidora de pegamento / Pistola incallitrice a caldo / Pistola p. Cola / Pistolet à colle / Lijmpistol

NEO
TOOLS



Ref.	Ø [mm]	⊠	EAN
17-080	11,2	6/12	5907558400113

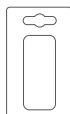

NEO
TOOLS



Ref.	Ø [mm]	⊠	EAN
17-082	11,2	6/12	5907558400120

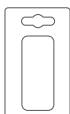

TOPEX



Ref.	P [W]	q [g/min]	⊠	EAN
42E501	25/78	12-18	10/40	5902062091130

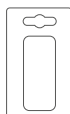

TOPEX



Ref.	P [W]	q [g/min]	⊠	EAN
42E580	10	3	12/48	5902062013538

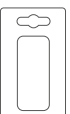

TOPEX



Ref.	P [W]	q [g/min]	⊠	EAN
42E521	20/200	12	12/48	5902062425218

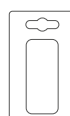

TOPEX



Ref.	P [W]	q [g/min]	⊠	EAN
42E522	20/200	15	12/48	5902062425225

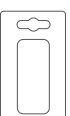

TOP TOOLS



Ref.	Ø [mm]	q [g/min]	⊠	EAN
42E500	11,2	8 - 12	12/24	5902062130099

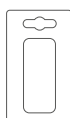

TOP TOOLS



Ref.	Ø [mm]	q [g/min]	⊠	EAN
42E581	11,2	6 - 8	24/48	5902062130105

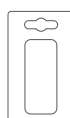

Wkłady klejowe

Glue sticks / Leimpatronen / Стержни клеевые / Стружичи клејови / Ragasztópatron átlátszó fehér / Mandriná de lipit / Tyčinky lepidla / Tyčiky lepiace / Lepilo v palicah / Ključ lazdelés / Limes stobriņi / Liimpulgad / Силунок на пръчки / PVC štarići / PVC starici / Φασίγια θερμοκόλλας / Cartuchos de pegamento / Sticks di colla / Cartuchos de cola / Cartouches de colle / Lijmstift

TOPEX

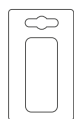
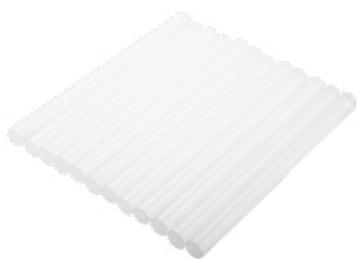
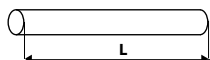

Ref.	Ø [mm]	L [mm]	N	kolor	kg	kg	kg	EAN
42E113	11	250	x12		0,300	0/50	5902062130402	
42E171	11	250	x12		0,300	10/50	5902062130419	
42E172	11	250	x12		0,300	0/50	5902062130426	
42E173	11	250	x12		0,300	0/50	5902062130433	

TOPEX

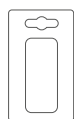
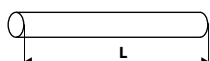

Ref.	Ø [mm]	L [mm]	N	kolor	kg	kg	EAN
42E180	8	100	x12		100/200	5902062013545	

TOPEX

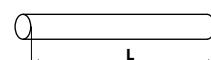

Ref.	Ø [mm]	L [mm]	N	kolor	kg	kg	EAN
42E154	11	300	x65		2	0/5	5902062421548
42E155	11	300	x167		5	0/1	5902062130600

TOPEX

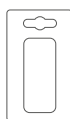
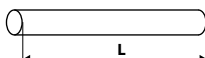

Ref.	Ø [mm]	L [mm]	kg	EAN
42E181	8	100	100/200	5902062000057
42E182	8	100	100/200	5902062000064

TOP TOOLS

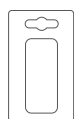
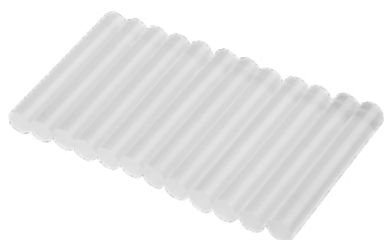

Ref.	Ø [mm]	L [mm]	N	kolor	-kg	kg	EAN
42E081	8	50	x12		0,031	0/500	5902062130136
42E110	11,2	100	x6		0,060	0/200	5902062130204

TOP TOOLS



Ref.	Ø [mm]	L [mm]	N	kolor	-kg	kg	EAN
42E151	11,2	200	x50		1,000	0/12	5902062130594
42E152	11,2	200	x100		2,000	0/8	5902062130587

Nitownica

Riveter / Nietmaschine / Заклепочник / Клепальний інструмент / Popszegecszű / Mašinà de nituit / Nytovačka / Kliešte nitovacie oceľové / Pištolà za kovčenje / Kniediklis / Kniežu stangas / Needitangid/ Нитачка / Klijesta za zakovice / Pistolj za pop nitne / Нлч / Remachadora / Rivettatrice / Rebitadora / Riveuse / Klinknagelmachine

NEO TOOLS



	Ø 2,4/3,0/3,2/4,0/4,8/5,0 mm		Ø 2,4/3,0/3,2/4,0/4,8/5,0 mm
	Ø 2,4/3,0/3,2/4,0/4,8/5,0 mm		Ø 2,4/3,0/3,2/4,0 mm

Ref.	Ø [mm]	L [mm]	kg	EAN
18-101	2,4/3,2/4,0/4,8	264	10/30	5907558400137

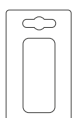

NEO TOOLS



	Ø 2,4/3,0/3,2/4,0/4,8/5,0 mm		Ø 2,4/3,0/3,2/4,0/4,8/5,0 mm
	Ø 2,4/3,0/3,2/4,0/4,8/5,0 mm		Ø 2,4/3,0/3,2/4,0/4,8/5,0 mm

Ref.	Ø [mm]	L [mm]	kg	EAN
18-103	2,4/3,2/4,0/4,8	265	10/30	5907558405811

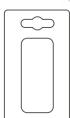

NEO TOOLS



	Ø 2,4/3,0/3,2/4,0/4,8/5,0/6,0/6,4 mm		Ø 2,4/3,0/3,2/4,0/4,8/5,0/6,0/6,4 mm
	Ø 2,4/3,0/3,2/4,0/4,8/5,0/6,0/6,4 mm		Ø 2,4/3,0/3,2/4,0/4,8/5,0/6,0/6,4 mm

Ref.	Ø [mm]	L [mm]	m [kg]	kg	EAN
18-106	3,2/4,0/4,8/6,0/6,4	480	1,95	0/10	5907558412246

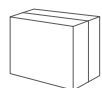

Nitownica

Riveter / Nietmaschine / Заклепочник / Клепальный инструмент / Popszegecszűz / Mašina de nituit / Nýtovačka / Kliešte nitovacie ocelové / Pištola za kovčenje / Kniediklis / Kniežu stangas / Needitangid/ Нитачка / Kliešta za zakovice / Pistolj za pop nitne / Нлч / Remachadora / Rivettatrice / Rebitadora / Riveuse / Klinknagelmachine

NEO
TOOLS



NEO
TOOLS



Ø 2,4/3,0/3,2 mm



Ø 2,4/3,0/3,2/4,0/4,8/5,0 mm



Ø 2,4/3,0/3,2 mm



Ø 2,4 mm

Ref.	Ø [mm]	L [mm]	⊠	EAN
18-102	2,4/3,2/4,0/4,8	280	10/20	5907558400144



Ø 2,4/3,0/3,2/4,0/4,8 mm



Ø 2,4/3,0/3,2/4,0/4,8 mm



Ø 2,4/3,0/3,2/4,0/4,8 mm



Ø 2,4/3,0/3,2/4,0/4,8 mm

Ref.	Ø [mm]	L [mm]	m [kg]	⊠	EAN
18-107	2,4/3,2/4,0/4,8	275	0,75	6/24	5907558413564

T TOPEX



2,4

3,2

4,0

4,8



Ref.	L [mm]	⊠	EAN
43E707	250	10/40	5902062020666

T TOPEX



2,4

3,2

4,0

4,8



Ref.	L [mm]	⊠	EAN
43E701	260	0/24	5902062020079

T TOPEX



2,4

3,2

4,0

4,8



Ref.	L [mm]	⊠	EAN
43E712	270	0/24	5902062020260

T TOPEX



2,4

3,2

4,0

4,8

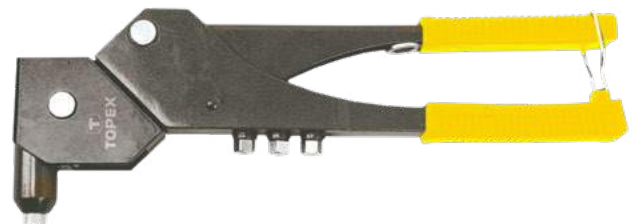

Ref.	L [mm]	⊠	EAN
43E713	300	0/24	5902062020246

T TOPEX



2,4

3,2

4,0

4,8



Ref.	L [mm]	m [kg]	⊠	EAN
43E780	535	1,3	0/10	5902062020130

TOP TOOLS



Ref.	Ø [mm]	L [mm]	⊠	EAN
43E703	2,4; 3,2; 4,0; 4,8	249	0/24	5902062020239

Nity

Rivets / Nieten / Закленки / Кленки / Popszegecs / Şuruburi / Nýty / Nit hliníkový trhací / Kovice / Kniedés / Kniedes / Needid / Humose / Zakovice / Pop nitne / Ηλοι / Remaches / Rivetti / Rebites / Rivets / Klinknagels

TOPEX

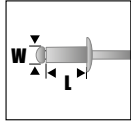

ALUMINIUM

Ref.	WxL [mm]	N				EAN
43E301	3,2 x 8	x50	x			0/400 5902062020154
43E302	3,2 x 10	x50	x			0/400 5902062020192
43E401	4,0 x 8	x50	x			0/200 5902062020161
43E402	4,0 x 10	x50	x			0/200 5902062020949
43E421	4,0 x 10	x800	x	x		0/20 5902062020987
43E403	4,0 x 12,5	x50	x			0/150 5902062020208
43E404	4,0 x 16	x50	x			0/150 5902062020284
43E405	4,0 x 18	x50	x			0/150 5902062020291
43E501	4,8 x 8	x50	x			0/150 5902062020178
43E502	4,8 x 10	x50	x			0/120 5902062020215
43E503	4,8 x 12,5	x50	x			0/120 5902062020956
43E504	4,8 x 14,5	x50	x			0/120 5902062020222
43E505	4,8 x 18	x50	x			0/100 5902062020307
43E507	4,8 x 23	x50	x			0/100 5902062020314
43E509	4,8 x 28	x50	x			0/90 5902062020321

Nitownica do kołków rozporowych

Riveter for expansion pins / Nietpresse für Spreizdübel / Заклепочник для распорных дюбелей / Заклепочник / Tiplizőfogó / Presă de nituit / Nýtovačka pro rozprácní kolíky / Nitovačka na rozpretné nity / Kovičnik za zakrivanje klinov / Profiliju kniediklis / Pretbidna kniedētājs / Löötsaga needitangid / Нитовачка за распорни болтове / Alat za zakivanje tipli / Mašina za zakivanje klinova / Πριταναδόρος για κωνικές σπήνες / Remachadora para pasadores de espiga / Rivettatrice / Rebitadora para pinos / Riveuse pour chevilles expansibles / Klinknagelmachine voor uitzetpenen

TOPEX

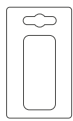

Ref.	L [mm]		EAN
43E790	255	12/36	5902062427908

4,0
Ø [mm]

5,0
Ø [mm]

6,0
Ø [mm]

TOPEX

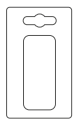

Ref.	L [mm]		EAN
43E791	170	12/24	5902062427915

3,0
Ø [mm]

4,0
Ø [mm]

5,0
Ø [mm]

6,0
Ø [mm]

Nitownica na nitonakrętki

Nut riveter / Nietmaschine für Nietmuttern / Заклепочник для заклепочных гаек / Клепальный инструмент для мутр / Popszegecs húzó anyaszzegecs húzó / Maşină de nituit piuliţă / Nýtovačka nýtových šroubů / Kliešte nitovacie / Pištola za kovičenje / Kniediklis besisukantis / Kniežu stangas / Neetmutritangid / Ημπαύκη / Nitne zakovice / Pistolj za pop nitne / Πριταναδόρος για πριταίνα / Remachadora para remaches de rosca / Rivettatrice / Rebitadora p. Rebites e porcas / Riveuse à rivets à jaquette / Klinknagelmachine voor moer klinknagels

TOPEX

AL
M3/M4/M5/
M6/M8



Ref.		EAN
43E111	0/18	5902062064172

Nitonakrętki

Nut rivets / Nietmuttern / Γαίηκi заклепочные / Кленки мутровi / Anyaszzegecs / Maşină de nituit piuliţă / Nýtové šrouby / Nitové matice / Kovice / Kniedés veržles / Kniežu stangas / Neetmutrid / Ημπαύκη / Nitne zakovice / Pistolj za pop nitne / Πριταίνα / Remache de rosca / Rivetti / Rebites e porcas / Rivets à jaquette / Moer klinknagel

TOPEX

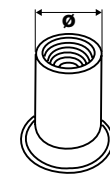

x20

ALUMINIUM

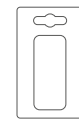

Ref.	Typ	Ø [mm]		EAN
43E133	M3	4,9	20/200	5902062064134
43E134	M4	5,9	20/200	5902062064141
43E135	M5	6,9	20/200	5902062064158
43E136	M6	8,9	20/200	5902062064165

Szczypce do łączenia profili

Metal stud crimping tool / Profilverbindingsszange / Заклепочник прошивной для профилей / Клепальный инструмент / Peremezőfogó / Deşte p/u profiluri cu pereţi subţiri / Kliešte na spojování profilů / Kliešte nitovacie pre sadrokartónové profily / Klieše za spajanje profilov / Replés profíliams jungti / Stangas metala profíliem / Painutusnäpitsad poltidele / Ημπαύκη / Klijesta za zakovice / Klesta za zakivanje / Πέννα για συνένωση προφίλ / Tenazas para juntar perfíles / Utensile per perni metallici periferici / Pinças p. Juntar perfis / Pince à connecter des profilés / Tang voor profielen

TOPEX

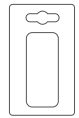

Ref.	L [mm]		EAN
43E100	350	5/20	5902062430007

TOPEX

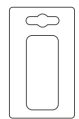

Ref.	L [mm]		EAN
43E101	260	6/24	5902062430014

Szczypce do nitów

Eyelet pliers / Nietzange / Заклепочник / Щипци клепаљни / Szegecselőfogó szeg / Clește pentru capse / Nýtovací kleště / Kliešte na nity / Klešče za zakovice / Replés kniediklės / Kniedētājs / Needitangid / Клеуци за нитове / Kliješta za zakovice / Klešta za nitne / Πρισταναβόρος / Alicates para remaches / Pinza occhiellatrice / Pinças p. Rebites / Pince à rivets / Klingsnagelstang

TOP TOOLS



x100

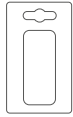

Ref.	L [mm]	⊠	EAN
32D422	165	5/50	5902062010711

Nity

Rivets / Nieten / Закленки / Кленки / Szegecs fogóhoz / Şuruburi / Nýty / Nit hliníkový trhací / Kovice / Kniedės / Kniedes / Needid / Humoos / Zakovice / Pop nitne / Ηλοι / Remaches / Occhielli / Rebites / Rivets / Klingsnagels

TOP TOOLS



x200

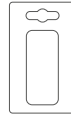

Ref.	info	⊠	EAN
32D420	for 32D422	20/400	5902062324207

Zestaw do lutowania

Soldering kit / LötKolben-Set / Набор для пайки / Набор до лютування / Forrasztófej / Garnitură de lipit cu aliaje / Sada pro pájení / Spájkovacia súprava / Komplet za spajkanje / Kompletas litavimui / Lodēšanas komplekts / Jootmiskomplekt / Комплект за запояване / Set za letjenje / Pribor za letjenje / Σετ συγκόλλησης / Equipo para soldar / Cannello / Kit p. Soldagem / Jeu de brasage / Soldeererset

NEO TOOLS



2 kW
1850 °C
140 g/h
1.5m

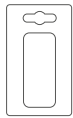

Ref.	P [kW]	⊠	EAN
20-011	2	0/10	5907558455106

NEO TOOLS



3-6 kW
1850 °C
210-430 g/h
1.5m

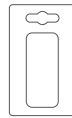

Ref.	P [kW]	⊠	EAN
20-012	3 - 6	0/10	5907558455113

TOPEX

1.5m

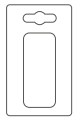

Ref.	T [°C]	q [g/h]	P [kW]	⊠	EAN
44E110	1850	140	2	0/10	5902062441102

TOPEX

1.5m

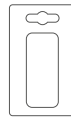

Ref.	T [°C]	q [g/h]	P [kW]	⊠	EAN
44E111	1850	140	2	0/10	5902062441119

Zestaw palników

Burners set / Brenner-Set / Набор зажигателей / Набор пальників / Forrasztó készlet / Set de suflaie / Sada hořáků / Súprava horákov / Komplet vžgalnikov / Deglikių kompleksas / Degļu kompleks / Pāletikomplekt / Комплект от горелки / Set grijača / Komplet gorionika / Σετ αναφλεκτήρων / Juego de sopletes / Kit per bruciatore a gas / Kit de Maçaricos / Jeu de chalumeaux / Set van branders

TOPEX

1.5m

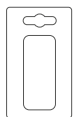
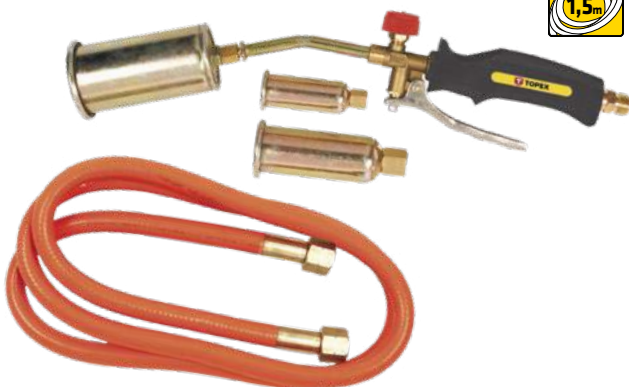

Ref.	T [°C]	q [g/h]	P [kW]	⊠ [kg]	⊠	EAN
44E115	1850	2000	19,5	0,9	0/6	5902062441157

TOPEX

1.5m

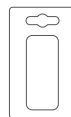

Ref.	T [°C]	q [g/h]	P [kW]	⊠ [kg]	⊠	EAN
44E120	1400	2000	28	1,1	0/10	5902062441201

Zestaw palników

Burners set / Brenner-Set / Набор зажигателей / Набор пальників / Forrasztó készlet / Set de suflaie / Sada hořáků / Súpava horákov / Komplet vžigalnikov / Degiklių komplektas / Degļu komplekts / Pāletikomplekt / Комплект от горелки / Set grijača / Komplet gorionika / Σετ αναφλεκτήρων / Juego de sopletes / Kit per bruciatore a gas / Kit de Maçaricos / Jeu de chalumeaux / Set van branders

TOPEX



Ref.	T [°C]	q [g/h]	P [kW]	kg [kg]	kg [kg]	EAN
44E117	1850	max 2000	28	5,6	0/3	5902062441171

Lutownica gazowa

Soldering torch / GaslötKolben / Газовый паяльник / Лютувальник газовой / Forrasztó készlet / Ciocan de lipit, cu gaz / Plynová páječka / Plynová spájkováčka / Plinski spajkalnik / Dujinis lituoklis / Gázes lodāmurs / Gaasjoetekolb / Газов паяльник / Plinska lemilica / Gasna lemilica / Καυνέτο / Soldadura a gas / Soldatore a gas / Soldador de gás / Fer à souder à gaz / Gassoldeerbout

TOPEX

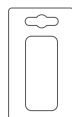

Ref.	T [°C]	q [g/h]	P [kW]	kg [kg]	kg [kg]	EAN
44E118	1850	140	2	1,1	0/6	5902062441188

Zestaw dekarski

Roofwork kit / Dachdecker-Set / Набор кровельщика / Набор дахарський / Forrasztó készlet / Set de țiglărie / Pokrývačská sada / Pokrývačská súprava / Komplet za krovce / Komplektas stogdengiu / Jumika kompleks / Katusepanijakomplekt / Покривачески комплект / Krovopokrivači set / Krovni komplet / Σετ στεγαστή / Juego de herramientas de techador / Accessorio per coperture / Kit especial / Jeu d'outils de couvreur / Dakwerkset

TOPEX

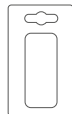
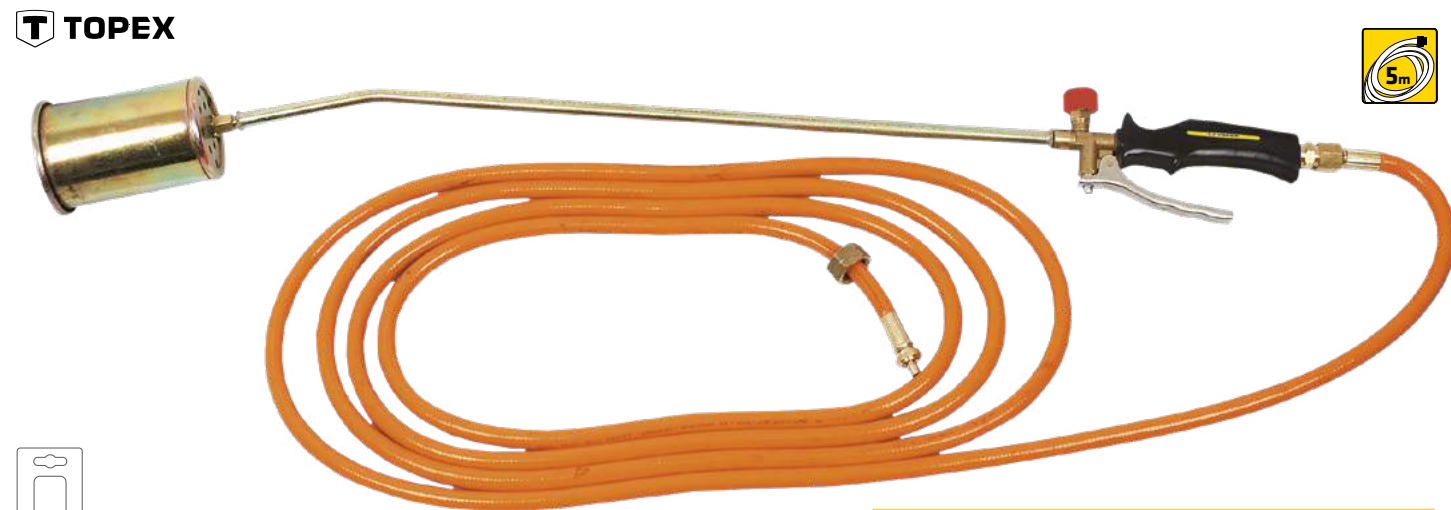

Ref.	T [°C]	q [g/h]	P [kW]	kg [kg]	kg [kg]	EAN
44E122	1850	4000	58	1,5	0/6	5902062441225

TOPEX

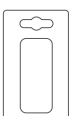
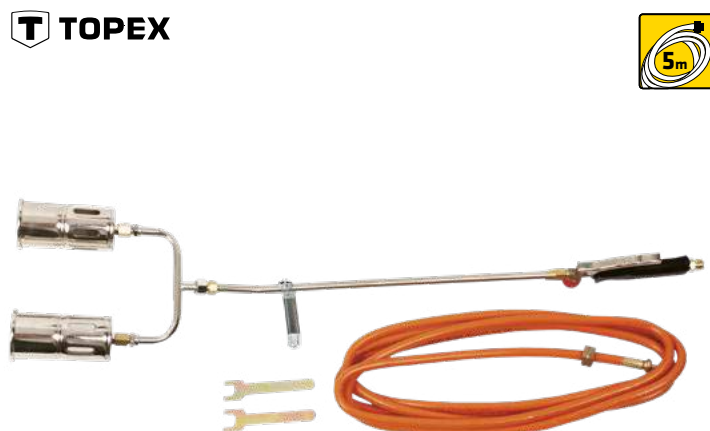

Ref.	T [°C]	q [g/h]	P [kW]	kg [kg]	kg [kg]	EAN
44E121	1850	7800	110	1,5	0/6	5902062441218

TOPEX

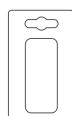

Ref.	T [°C]	q [g/h]	P [kW]	kg [kg]	kg [kg]	EAN
44E123	1850	6900	99	1,8	0/6	5902062441232

Reduktor ciśnieniowy

Pressure reducer / Druckminderer / Редуктор давления / Редуктор тиску / Nyomásszabályzó / Reductor de presiune / Tlakový reduktor / Tlakový reduktor / Tlačni reduktor / Sléiginis reduktorius / Spiediena reduktors / Röhreduktor / Редуктор на налягането / Reduktor pritiska / Reduktor pritiska / Μεωτήρας πίεσης / Reductor de presión / Riduttore di pressione / Redutor de tensão / Réducteur de pression / Drukreduktiestuk



Ref.	⊠	EAN
20-130	0/6	5907558460247

Redukcja do butli

Reduction for cylinder / Reduzierstück für Flasche / Редуктор для бутылки / Редуктор на балон / Hollandi gázpalackhoz / Reducție la butelie / Reducție na láhve / Adaptér na kartuše / Ventil za jeklenko / Dujų baliono reduktorius / Reduktors / Ballooinreduktor / Редукция за бутылката / Redukcija za bocu / Smanjenje za cilindar / Μεωτήρας για बोξείο / Adaptator para botella / Adattatore / Redução p. Garrações / Réduction pour bouteille / Reductiestuk voor flessen

TOPEX



Ref.	⊠	EAN
44E139	0/50	5902062441393

Wąż przyłączeniowy do gazu

Gas connecting hose / Gasumschaltsschlauch / Шланг газоподводящий / Шланг газовой / Gáztöltő hosszabító / Furtun de racord, pentru alimentare gaz / Přípojná hadice na plyn / Přípojná hadica na plyn / Priključna cev za plin / Prijungimo vamzdis, dujoms / Gāzes pievadšūtene / Gaasiühendusvoolik / Газопроводен маркуч / Priključno crijevo za plin / Priključno crevo za gas / Εύκαμπτος σωλήνας παροχής αερίου / Manguera de conexión para gas / Tubo di connessione per gas / Mangueira de ligação p. Gás / Tujau flexible de raccordement à gaz / Verbindings slang voor gas

TOPEX



Ref.	Info	L [m]	do butli	⊠	EAN
44E152	3/8" x 3/8" L	2	5 kg	0/6	5902062441232
44E155	3/8" x 1/2" L	5	11 kg	0/6	5902062441553

Palnik gazowy

Gas burner / Gasbrenner / Горелка газовая / Пальник газовой / Forrasztófej / Arzător de gaz / Plynový hořák / Horák / Plinski gorilnik / Dujinis degiklis / Gāzes deglis / Gaasipaleti / Нагрівачик за горелка / Nastavak za plamenik / Gasna lemilica / Καυστήρας υγραερίου / Soplete / Beccuccio / Maçarico de gás / Chalumeau à gaz / Gasbrander

NEO TOOLS



Ref.	T [°C]	P [kW]	⊠	EAN
20-025	1300	1.3	10/100	5907558449648

Lampa lutownicza

Liquid gas blow-lamp / Lötlampe / Лампа паяльная / Газ рідкий для лампи паяльної / Forrasztókészülék / Lampă sudat cu gaz lichid / Pájeci lamp / Pájkováčka plynová / Plinski gorilnik / Litavimo lempa / Lötlampe / Jootelamp (vedelgaas) / Лампа газова / Plinska lemilica / Gasna lemilica / Καυμένο υγραερίου / Lámpara de soldar a gas / Lampada per saldare / Lâmpada p. Soldar / Lampe à braser / Soldeerlamp

NEO TOOLS



Ref.	T [°C]	q [g/h]	P [kW]	⊠	EAN
20-021	1350	87	1.2	0/12	5907558455151

NEO TOOLS



Ref.	T [°C]	q [g/h]	P [kW]	⊠	EAN
20-022	1350	87	1.2	0/12	5907558455168

TOPEX

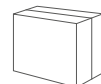

Ref.	T [°C]	q [g/h]	P [kW]	⊠	EAN
44E140	1350	190	1,9	0/20	5902062996824

TOPEX



44E141



44E143

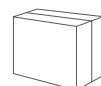

Ref.	T [°C]	q [g/h]	P [kW]	⊠	EAN
44E141	1350	180	1,9	0/14	5902062441430
44E143	1350	180	1,9	0/14	5902062021021

Lampa lutownicza

Liquid gas blow-lamp / Lötlampe / Лампа паяльная / Газ рідкий для лампи паяльної / Forrasztókészülék / Lampă sudat cu gaz lichid / Pájecí lampa / Pájkovačka plynová / Plinski gorilnik / Litavimo lempa / Lodlampa / Jootelamp (vedelgaas) / Лампа газова / Plinska lemilica / Gasna lemilica / Καυνέτο υπαρείου / Lámpara de soldar a gas / Lampada per saldare / Lámpada p. Soldar / Lampe à braser / Soldeerlamp

TOPEX



PLASTIC BODY

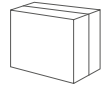

Ref.	info	T [°C]	q [g/h]	P [kW]	⊠	EAN
44E142	-	1350	180	1,9	0/14	5902062441416
44E148	+ 6 x 44E150	1350	180	1,9	0/8	5902062019257
44E154	+ 4 x 44E150	1350	180	1,9	0/10	5902062070203

Nabój z gazem butan

Butane gas cartridge / Butan-Gas-Patrone / Баллон с газом бутан / Балончики (картриджі) з газом бутан / Tartály gázlámpához / Cartuş cu gaz butan / Kartuše s plynem butan / Butánová kartuša / Jeklenka s plinom butan / Butano dūjų balionas / Balons ar butāna gāzi / Butaan-gaasipadrón / Бутылка с газ бутан / Patrona sa butan plinom / Patrona sa butan gasom / Δοχείο με μείγμα βουτανίου / Cartucho de gas butano / Bombola di gas / Cartuxo com gás / Cartouche avec gaz butane / Butaan vervangcartridge

NEO TOOLS



227 g

Ref.	⊠	EAN
20-030	4/28	5907558449655

TOPEX



190 g GAS STOP EN417: 2012

Ref.	⊠	EAN
44E150	0/48	5902062004772

Lutownica oporowa

Soldering iron / Widerstandslötkolben / Паяльник контактный / Паяльник / Forrasztóraka / Ciocan de lipit / Odporová páječka / Pájkovačka hrotová odporová / Spajkalnik / Lituoklis / Lodātmurs / Jootekolb / Паяльник / Električna lemilica / Pistolj lemilica / Εμβόλο συγκολλησεων / Soldador / Soldatore elettrico / Soldador por resistència / Fer à souder à résistance / Weerstand soldeerbout

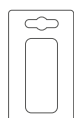
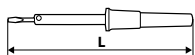

Ref.	P [W]	L [mm]	⊠	EAN
44E024	40	217	10/50	5902062172327
44E026	60	237	10/50	5902062172334
44E029	100	273	25/50	5902062020574

Mikropalnik

Microtorch / Mikrobrenner / Микрогорелка / Мініпаяльник / Forrasztókészülék piezos / Microinjector / Mikrohořák / Mikro pájkovačka / Gorilnik / Mikro degiklis / Lodlampa mini / Mikroelekklamp / Горелка микро / Mikro Plinska lemilica / Mikro gasna lemilica / Φλόγιστρο / Microsoplete / Micro bruciatore / Mikroaçarico / Micro-brûleur / Microbrander

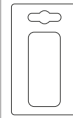

Ref.	L [mm]	⊠	EAN
19-901	170	10/60	5907558409000

TOPEX

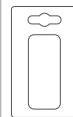

Ref.	T [°C]	V [ml]	⊠	EAN
44E106	1300	28	10/20	5902062441065

TOPEX

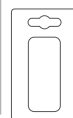

Ref.	T [°C]	V [ml]	⊠	EAN
44E108	200-400	12	0/20	5902062441089

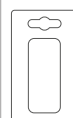
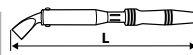

Ref.	P [W]	L [mm]	⊠	EAN
44E030	150	350	10/20	5902062440303
44E031	200	355	10/20	5902062440310

Lutownica transformatorowa

Soldering gun / Trafo-Lötkolben / Паяльник трансформаторный / Паяльный пистолет / Forrasztópisztoly / Cioacan de lipit / Pájeci stanice s transformátorem / Pájkováčka elektronická / Spajkalnik / Transformatorinis lituoklis / Lodāmurs ar transformātoru / Jootepüstol / Паяльник / Pištolj lemilica / Pistola lemilica / Ηλεκτρικό κολλητήρι με μετασχηματιστή / Pistola para soldar / Pistola per saldatura / Soldador por transformador / Fer à souder redresseur / Transformator soldeerbout

TOPEX



Ref.	P [W]	⊠	EAN
44E002	100	10/10	5902062021045

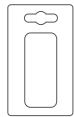

TOPEX



Ref.	P [W]	⊠ [kg]	⊠	EAN
44E005	150	1,5	0/10	5902062671509

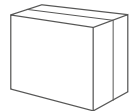

TOP TOOLS



Ref.	P [W]	⊠	EAN
44E000	100	0/24	5902062020550

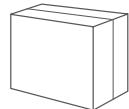

Końcówki do lutownicy transformatorowej

Tips for soldering gun / Trafo-Lötkolbenendstücke / Наконечники для паяльного пистолета / Наконечники для паяльника трансформаторного / Hroty náhradné / Nastavki za spajkalnik / Transformatorinio lituoklio antgaliai / Uzgoļi lodāmuram ar transformātoru / Jootepüstoli otsikud / Накрайник за паяльник / Nastavci za pištolj lemilicu / Nastavci za pistolj lemilicu / Μύτες ηλεκτρικού κολλητήριου με μετασχηματιστή / Puntas para pistola de soldar / Punte per pistola saldatrice / Ponteiros p. soldador / Embouts de fer à souder redresseur / Eindstuk voor transformator solderen

TOPEX



Ref.	info	N	⊠	EAN
44E004	for 44E005	3	0/1000	5902062440044
44E007	for 44E002	2	25/100	5902062440075

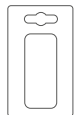

TOP TOOLS



Ref.	info	⊠	EAN
44E003	for 44E000	100/600	5902062020963

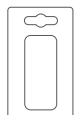

Odsysacz cyny

Desoldering pump / Zinn-Absauger / Пистолет для снятия припоя / Циновідсмоктувач / Ópszívó / Dispozitiv de aspirarea cositorului / Odsavač cínu / Odsávač cínu / Odstranjavec cina / Alavo siurblys / Lodālvas atsūkņētājs / Tinaimur / Καλαena pomna / Sisaljka za kositar / Usisivač za kalaj / Αρλιά αφαιρέσης κόλλησης / Dispositivo de aspiración de estaño / Pompa dissaldante / Máquina de remover estaño / Pompe à braser à l'étain / Tinafzuiger



TOPEX



Ref.	L [mm]	⊠	EAN
44E006	190	100/200	5902062440068

Spoiwo lutownicze

Solder wire / Lötlegierung / Присадоchnий паяльный материал / Люта / Forrasztóó / Liant / Pojivo pro ráženi / Sprjka / Spajkalna žica / Lodššanas saistviela / Jootetāide / Πρινού / Spojnica za lemjenje / Vezivo za lemjenje / Καλάι / Metal de aportación para soldadura / Filo per saldare / Solda / Liant de brasure / Soldeernaald

TOPEX



Ref.	Sn %	Ø [mm]	m [g]	topnik	⊠	EAN
44E512	60	0,7	100	SW 26	0/190	5902062020680
44E514	60	1,0	100	SW 26	0/144	5902062020703
44E522	60	1,0	100	SW 26B	0/144	5902062020741
44E524	60	1,5	100	SW 26B	0/144	5902062020765
44E532	60	1,5	100	SW 21	0/144	5902062020789

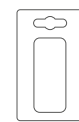

Lut cynowy

Tin solder / Lötzinn / Πρινού οловянный / Люта цинова / Forrasztóó / Aliaj de lipit din cositor / Cínová rájka / Cín rajkovač / Tinol žica / Aliuminio lydmetalis / Lodalva / Tinajoodis / Тинол / Tinol žica / Tinol žica / Καλάι / Soldadura de estaño / Lega per saldatura di stagno / Solda / Soudure d'étain / Zink soldeernaald

Cynel
unipress



Ref.	Sn %	Cu %	Ø [mm]	m [g]	⊠	EAN
44E742	97	3	2,5	100	0/180	5902062020802

Cynel
unipress

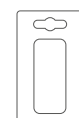

Ref.	Sn %	Ø [mm]	L [mm]	N	⊠	EAN
44E517	60	7 x 7	250	1	0/210	5902062994974
44E519	60	7 x 7	250	3	0/70	5902062020727

Kalafonia

Calophony / Kolophonium / Канифоль / Канифоль / Forrasztó gyanta / Colofoni (sacáz) / Kalafuna / Kolofónia / Kolofonija / Kanifolija / Kolofonjis / Vaik / Καλοфон / Kalafonija / Kolofonijum / Καλοφωνία πiσα / Colofonia / Colofonia / Colofónia / Colophane / Colofonium

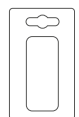

Cynel
unipress

Ref.	m [ml/g]	⊠	EAN
44E812	35	0/180	5902062020826

Topnik

Paste flux / Flussmittel / Флюс / Паста-πρινού / Folyósítószer / Flux pastă / Tavnici přísady / Pasta na rájkovanie / Tinol žica / Litavimo pasta flusas / Lodpasta / Jootepasta / Паста за запояване / Tinol pasta / Tinol žica / Πάστα συγκόλλησης / Fundente: pasta / Fondente / Fundente / Décapant / Flux

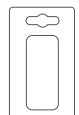

Cynel
unipress

Ref.	m [ml/g]	⊠	EAN
44E816	35	0/180	5902062020840

Zestaw do lutowania

Soldering kit / LötKolben-Set / Набор для пайки / Набор до лютування / Forrasztószett / Garnitură de lipit cu aliaje / Sada pro pájení / Spájkovací súprava / Komplet za spajkanje / Kompletas litavimui / Lodēšanas komplekts / Jootmiskomplekt / Комплект за запояване / Set za lemljenje / Pribor za lemljenje / Σειτ συγκόλλησης / Equipo para solda / Completo per saldatura / Kit p. Soldagem / Jeu de brasage / Soldeerset



Ref.	⊠	EAN
44E732	lut cynowy 60% Sn, Ø 1,5mm, SW21, 100g + pasta 35ml	5902062209429

Ref.	⊠	EAN
44E745	lut cynowy 97% Sn, 3% Cu, Ø 2,5mm, 100g + topnik 100g	5902062209436

Ref.	⊠	EAN
44E731	lut cynowy 60% Sn, Ø 1,5mm, SW21, 100g + kalafonia 35ml	5902062209412

Zgrzewarka

Welder / Schweißmaschine / Сварочный аппарат / Пристрій до зварювання / Csőhegesztőgép / Mašina de sudat / Svářečka / Zváračka / Varilnik / Suvirino aparatas / Metināšanas aparāts / Keevitusaparaat / Заварьча машина / Aparat za varjenje / Zavarivač / Μηχάνημα συγκόλλησης / Soldadora / Polifusore per tubi in plastica / Máquina de solda / Soudeuse / Lasapparaat



Zgrzewarka

Welder / Schweißmaschine / Сварочный аппарат / Пристрій до зварювання / Csőhegesztőgép / Maşină de sudat / Svařečka / Zváračka / Varilnik / Suvirinimo aparatas / Metināšanas aparāts / Kevvitusaparaat / Zavarčna mašina / Aparat za varenje / Zavarivač / Μηχάνημα συγκόλλησης / Soldadora / Polifusore per tubi in plastica / Máquina de solda / Soudeuse / Lasapparaat

TOPEX



230V-50Hz



Ref.	P [W]	T [°C]	Ø [mm]	kg [kg]	Box	EAN
44E160	800	0 - 300	20, 25, 32, 40	2,9	0/6	5902062441607

Tuleja grzewcza

Heating sleeve / Heiztülle / Насадки к аппарату для сварки полимерных труб / Втулка нагривальна / Melegítő talpat / Matrite pentru lipire tevi plastic / Ohřivací nástavec / Ohřevací nadstavec / Grelna tulka / Suvirinimo mova / Metināšanas uzgalis / Süütedüüs / Нагревательная втулка / Grijaća prirubnica / Grejni tulac / Μούφες για μηχανήμα συγκόλλησης πολυμερών σωλήνων / Casquillos de calentador / Manicotto per polifusore / Casquillo aquecedor / Tubulaire de chauffage / Verwarmingsmouw

NEO TOOLS



PTFE

for 21-001 21-002 21-003

Ref.	Ø [mm]	Box	EAN
21-011	16	0/320	5907558408102
21-012	20	0/252	5907558408119
21-013	25	0/198	5907558408126
21-014	32	0/100	5907558408133
21-015	40	0/72	5907558408140
21-016	50	0/48	5907558408157
21-017	63	0/30	5907558408164
21-018	75	0/20	5907558408171
21-019	90	0/16	5907558408188
21-020	110	0/14	5907558408195

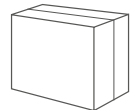

NEO TOOLS



PTFE

for 21-004

Ref.	Ø [mm]	Box	EAN
21-025	20	0/200	5907558463545
21-026	25	0/100	5907558463552
21-027	32	0/100	5907558463569

Śruba do tulei grzewczej

Screw for heating sleeve / Schraube für Heiztülle / Крепеж к насадкам / Гвинт до нагривальної втулки / Csavar toldathoz / Surub matrita lipire tevi plastic / Sroub pro ohřivací nástavec / Skrutka na ohřevací nadstavec / Vijak za grelnu tulku / Suvirinimo movos varžtas / Metināšanas uzgala skrūve / Süütedüüsi kruvi / Болт за нагревателната втулка / Vijak za grijaću prirubnicu / Zavrtanj grejnog tulca / Βίδα για μούφες / Tornillo para casquillo de calentador / Vite per polifusore / Parafuso para casquillo aquecedor / Vis à de tubulure de chauffage

NEO TOOLS

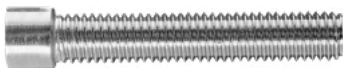

PTFE

for 21-001 21-002 21-003

Ref.	Ø [mm]	Box	EAN
21-021	16	120/1920	5907558408560
21-022	20, 25, 32	100/1600	5907558408577
21-023	40, 50, 63	100/1600	5907558408584
21-024	75, 90, 110	100/1600	5907558409413

Zestaw uszczelniający

Sealing set / Набор для уплотнения / Set de etanşare / Menettömítő készlet / Набор герметизирующий / Tesniaca súprava / Těsnící souprava / Dichtungssatz / Tesnlini set / Sandarinimo komplektas / Blivėjuma komplekts / Tihenduskomplekt / Уплътнителен комплект / Set za brtvljenje / Заптивни сет / Σετ αράγγισης / Juego de sellado / Set sigillante / Conjunto de vedação / Kit d'étanchéité / Afdichtingsset

NEO TOOLS



100g PASTE

50g OAKUM

Ref.	Box	EAN
02-109	0/2	5907558435870

Opaski zaciskowe

Band clips / Klemmschellen / Хомутки стяжные / Хомуты стяжні / Kábelkötéglő / Cleme conexiune / Hadicové pásky / Fixačné pásky / PVC vezice / Užspaudėjas / Savicēji / Rihmaklamber / PVC vezice / Κολλάρα σύφιξης / Fascette per cavi / Cintas p. gramppear / Bride de serrage / Klemmbanden

TOPEX



Ref.	color	W [mm]	L [mm]	N	Box	EAN
44E970	Black	2.5	100	x100	0/500	5902062023872
44E972	Black	2.5	200	x100	0/400	5902062023896
44E976	Black	3.6	200	x100	0/250	5902062023933
44E973	Black	3.6	300	x100	0/100	5902062023902
44E978	Black	4.8	200	x75	0/200	5902062023957
44E980	Black	4.8	300	x75	0/100	5902062023971
44E982	Black	4.8	370	x75	0/100	5902062023995
44E983	Black	7.6	500	x75	0/40	5902062024008
44E975	White	2.5	100	x100	0/500	5902062023926
44E971	White	2.5	200	x100	0/400	5902062023889
44E974	White	3.6	300	x100	0/100	5902062023919
44E977	White	4.8	200	x75	0/200	5902062023940
44E979	White	4.8	300	x75	0/100	5902062023964
44E981	White	4.8	370	x75	0/100	5902062023988
44E984	White	7.6	500	x75	0/40	5902062024015

TOP TOOLS



Ref.	color	W [mm]	L [mm]	N	Box	EAN
44E956	Black	2.5	100	x100	0/500	5902062449566
44E958	Black	2.5	200	x100	0/400	5902062449580
44E960	Black	3.6	300	x100	0/100	5902062449603
44E950	White	2.5	100	x100	0/500	5902062449504
44E952	White	2.5	200	x100	0/400	5902062449528
44E954	White	3.6	300	x100	0/125	5902062449542



DEKORATORSKIE
DECORATING ОТДЕЛОЧНЫЕ

Nóż z ostrzem łamanym

Snap-off blade knife / Messer m. gebrochener Klinge / Нож с отламывающимся лезвием / Ніж з ламаним лезом / Törhető pengés kés / Čužit lamě demontabilá / Nůž se zalomeným ostrím / Nožik lámací / Nož / Peilis su nulaužiama geležtė / Tapešu nazis / Kokkukäiva teraga nuga / Макетен нож / Skalpel / Skalpel / Koniči «snap Off» / Cúter / Taglierino con lama scorrevole / Faca com lâmina curvada / Couteau à lame cassable / Met met gebroken lemmet

NEO
TOOLS

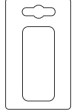

Ref.	W [mm]	📦	EAN
63-012	25	12/72	5907558443530

NEO
TOOLS

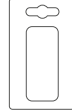

Ref.	W [mm]	📦	EAN
63-050	18	12/72	5907558420760

NEO
TOOLS

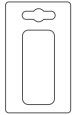

Ref.	W [mm]	📦	EAN
63-060	18	12/72	5907558420777



NEO
TOOLS

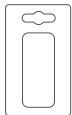

Ref.	W [mm]	📦	EAN
63-021	18	12/48	5907558410457

NEO
TOOLS

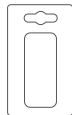

Ref.	W [mm]	📦	EAN
63-011	18	12/72	5907558410440

T TOPEX

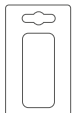

Ref.	W [mm]	D [mm]	📦	EAN
17B490	25	0,75	12/96	5902062141064

T TOPEX

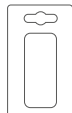

Ref.	W [mm]	D [mm]	📦	EAN
17B128	18	0,50	12/72	5902062140784

T TOPEX

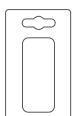

Ref.	W [mm]	D [mm]	📦	EAN
17B118	18	0,50	40/160	5902062140692

T TOPEX

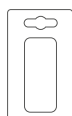

Ref.	W [mm]	D [mm]	📦	EAN
17B191	18	0,50	24/192	5902062009470

Nóż z ostrzem łamanym

Snap-off blade knife / Messer m. gebrochener Klinge / Нож с отламывающимся лезвием / Нож с ламаним лезом / Törhető pengés kés / Čužit lamä demontabilä / Nůž se zalomeným ostrím / Nožik lámací / Nož / Peilis su nulaužiama geležte / Trapešu nazis / Kokkukaiva teraga nuga / Макетен нож / Skalpel / Skalpel / Копiбi «snap Off» / Cúter / Taglierino con lama scorrevole / Faca com lâmina curvada / Couteau à lame cassable / Met met gebroken lemmet

TOPEX



Ref.	W [mm]	D [mm]	⊠	EAN
17B168	18	0,50	12/144	5902062140883

TOPEX

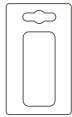

Ref.	W [mm]	D [mm]	⊠	EAN
17B428	18	0,50	12/144	5902062140890

TOP TOOLS

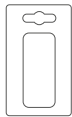

Ref.	W [mm]	⊠	EAN
17B518	18	24/360	5902062140029

TOP TOOLS



x3

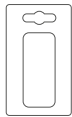

Ref.	N	⊠	EAN
17B533	x3	24/288	5902062202017

TOP TOOLS

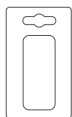

Ref.	W [mm]	D [mm]	⊠	EAN
17B328	18	0,50	25/150	5902062140524

TOPEX

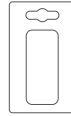

Ref.	W [mm]	D [mm]	⊠	EAN
17B103	18	0,50	12/72	5902062140975

TOPEX

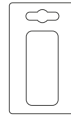

Ref.	W [mm]	D [mm]	⊠	EAN
17B109	9	0,40	50/400	5902062140791

TOP TOOLS

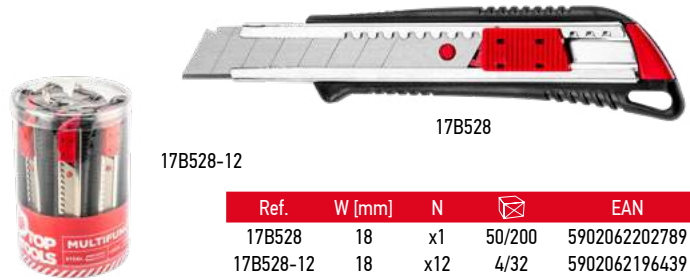

17B528-12

Ref.	W [mm]	N	⊠	EAN
17B528	18	x1	50/200	5902062202789
17B528-12	18	x12	4/32	5902062196439

TOP TOOLS



Ref.	⊠	EAN
17B531	25/100	5902062002945

Nóż z ostrzem trapezowym

Knife with utility blade / Messer mit Trapezklinge / Нож с трапецевидным лезвием / Нож з трапецевидним вістрям / Trapézpengés összecsukható kés / Cutter cu tăiș trapezoidal / Nůž s trapézovým ostrím / Nůž s trapézovou čepeľou / Nož s trapeznim rezilom / Peilis su trapecine geležte / Nazis ar trapecevida asmeni / Trapetsteraga nuga / Нож с трапецевидно острпе / Nož s trapezastom ostricom / Nož sa trapezastom ostricom / Μαχαίρι με τραπεζοειδή ακμή / Cúter con hoja trapezoidal / Taglierino a lama fissa / Faca com Lâminas de trapézio / Couteau à lame trapézoïdale / Trapezium mes

NEO TOOLS

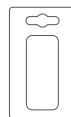

Ref.	W [mm]	⊠	EAN
63-702	18	0/80	5907558400212

Nóż z ostrzem trapezowym

Knife with utility blade / Messer mit Trapezklinge / Нож с трапецевидным лезвием / Ніж з трапецевидним вістрям / Trapézpengés összecsukskható kés / Cutter cu tăiş trapezoidal / Nůž s trapézovým ostřím / Nóż s trapézovou čepelou / Nož s trapéznim rezilom / Peilis su trapecine geležite / Nazis ar trapecveida asmeni / Trapetsteraga nuga / Нож с трапецеовидно острие / Nož s trapézastom ostricom / Nož sa trapézastom ostricom / Μαχαίρι με τραπεζοειδή ακμή / Cúter con hoja trapezoidal / Taglierino a lama fissa / Faca com Lâminas de trapézio / Couteau à lame trapézoïdale / Trapezium mes

NEO
TOOLS



TOPEX



Ref.	W [mm]	⊠	EAN
63-701	18	12/72	5907558400083

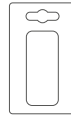

Ref.	W [mm]	D [mm]	⊠	EAN
17B140	155	0,65	10/100	5902062140593

TOPEX



Ref.	W [mm]	D [mm]	⊠	EAN
17B172	170	0,65	8/32	5902062140982

TOPEX

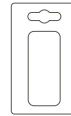

Ref.	W [mm]	D [mm]	⊠	EAN
17B160	175	0,65	6/36	5902062140913

Nóż monterski

Fitter's knife / Monteurmesser / Нож монтерский / Ніж монтерський / Bicska / Cutit pentru cabluri / Nůž montérský / Montérský nůž / Montažni nož / Montuotojo peilis / Montiera nazis / Elektriknuga / Монтёрски нож / Monterski nož / Monterski nož / Μαχαίρι ηλεκτρολόγου / Cuchillo recto para cables / Coltello a serramanico / Faca p. montagem / Couteau de monteur / Montagemes

TOPEX

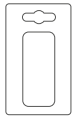

Ref.	L [mm]	⊠	EAN
17B632	180	30/300	5902062140241

TOPEX

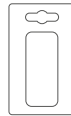

Ref.	L [mm]	⊠	EAN
17B656	180	25/250	5902062140265

TOPEX

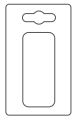
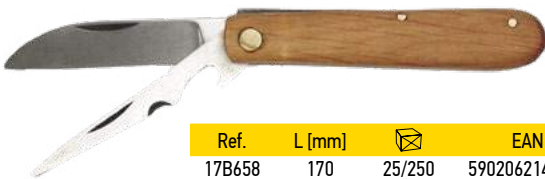

Ref.	L [mm]	⊠	EAN
17B658	170	25/250	5902062140272

TOPEX

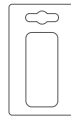

Ref.	L [mm]	⊠	EAN
17B639	180	15/150	5902062140258

Nóż do glazury

Tile knife / Fliesenmesser / Нож для кафельной плитки / Ніж для плитки / Kézi csempevágó / Cutit teracotă / Knife / Universalmesser / Нож универсальный / Ніж / Trapézpengés összecsukskható kés / Cutit / Univerzálni / Nůž na glazuru / Nůž na keramiku / Nož za ploščice / Peilis plytelėms / Nazis flīzēm / Plaadinuga / Нож за нůž / Nůž univerzálny / Nož / Universal peilis / Nazis / Nuga / Ножче / Džepni nožič / Nož / Μαχαίρι γενικής φανяс / Nož za ploščice / Noz za pločice / Κοπτική λεπίδα για πλακίδια / Cuchillo cortador de azulejos / Coltello per χρήση / Cuchillo universal / Taglierino a lama fissa / Faca universal / Couteau universel / Universele mes piastrelle / Faca para azulejos / Couteau à carrelage / Glazuurmes

TOPEX

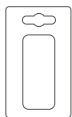

Ref.	L [mm]	⊠	EAN
16B420	170	0/50	5902062090232

Nóż uniwersalny

NEO
TOOLS

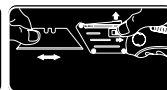

SAFETY
LOCK

x5

METAL
BODY

+

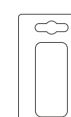

Ref.	⊠	EAN
63-710	6/48	5907558420791

Nóż uniwersalny

Knife / Universalmesser / Нож универсальный / Нож / Bicska / Cuijt / Univerzální nůž / Nóż uniweryalny / Nož / Universalus peilis / Nazis / Nuga / Ножиче / Džepni Nožić / Noz / Μαχαίρι γενικής χρήσης / Cuchillo universal / Coltella a serramanico / Faca universal / Couteau universel / Universele mes

TOPEX

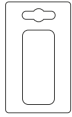

Ref.	L [mm]	⊠	EAN
98Z007	80	12/120	5902062140869

TOPEX

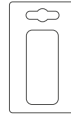

Ref.	L [mm]	⊠	EAN
98Z017	75	12/72	5902062140654

TOPEX

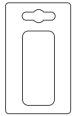

Ref.	L [mm]	⊠	EAN
98Z103	120	10/50	5902062981035

TOPEX

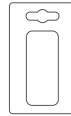

Ref.	L [mm]	⊠	EAN
98Z101	220	12/108	5902062981011

TOPEX

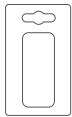

Ref.	L [mm]	⊠	EAN
98Z105	185	12/108	5902062981059

TOPEX

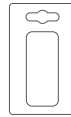

Ref.	L [mm]	⊠	EAN
98Z110	205	12/108	5902062981103

TOPEX

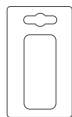

Ref.	L [mm]	⊠	EAN
98Z106	175	6/48	5902062012944

TOPEX

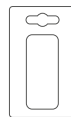

Ref.	L [mm]	⊠	EAN
98Z107	190	6/48	5902062012951



TOP TOOLS

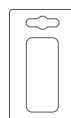

Ref.	L [mm]	⊠	EAN
98Z102	205	10/100	5902062981028

Narzędzie wielofunkcyjne

Multipurpose tool / Allzweckwerkzeuge / Инструмент универсальный / Инструмент багатофункцыйны / Multiszerszám / Unealta multifuncionala / Multifunkční nástroj / Viacfunkčné náradie / Večfunkcijsko orodje / Daugiafunkciniai įrankiai / Daudzfunkcionālie instrumenti / Multifunktsionaalne tööriist / Мультифункционален инструмент / Višenamjenski uređaj / Višefunkcionalne alatke / Πολυεργαλείο / Herramienta multiuso / Utensile multiuso / Aparelho multifunções / Outil multifonction / Multifunctioneel gereedschap

T TOPEX



**13
in 1**

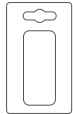

Ref.	L [mm]	☒	EAN
98Z053	170	12/48	5902062980533

TOP TOOLS



**11
in 1**

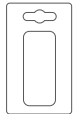

Ref.	☒	EAN
98Z028	30/120	5902062038289

Ostrza łamane

Snap off blades / Klängen, abbrechbar / Лезвия сменные отламывающиеся / Леза змінні, що обламуються / Törhető penge / Lame cutter / Odlamovací čepele / Odlamovacie čepele / Lomljiva rezila / Laužomi peiliukai / Maināmie nolaužāmie asmeņi / Vaibanoa terad / Отщипуващи се остриета / Lomljene oštrice / Lomljene oštrice / Αποσπώμενες λεπίδες / Hojas segmentadas / Ricambio lame scorrevoli / Láminas curvadas / Lames coupées / Gebogen bladen

NEO TOOLS

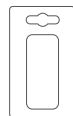

Ref.	L [mm]	☒	EAN
64-012	9	10/120	5907558443547
64-013	18	10/120	5907558443554
64-014	25	10/120	5907558443561

NEO TOOLS



Ref.	W [mm]	☒	EAN
64-010	18	10/300	5907558400229

NEO TOOLS

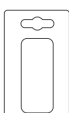

Ref.	W [mm]	☒	EAN
64-020	18	10/300	5907558400236

NEO TOOLS



Ref.	W [mm]	☒	EAN
64-210	9	10/300	5907558400243

T TOPEX



+

**9
in 1**



Ref.	☒	EAN
98Z058	10/40	5902062012937

Scyzoryk

Knife / Klappmesser / Нож перочинный / Нѳк / Zsebkés / cuřit / Каресни нѳз / Nѳz / Noř / Peiliukas / Nazis / Nuga / Noz / Μαχαίρι γενικής χρήσης / Cortaplumas / Temperino / Canivete / Canif / Zakmes

T TOPEX

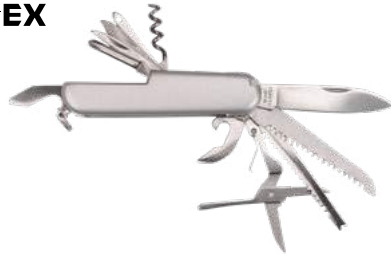

**11
in 1**

**STAINLESS
STEEL**



Ref.	☒	EAN
98Z116	12/108	5902062981158

TOP TOOLS

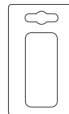

Ref.	☒	EAN
98Z027	12/144	5902062140395

Ostrza lamane

Snap off blades / Klengen, abbrechbar / Лезвия сменные отламывающиеся / Леза змінні, що обламуються / Törhető penge / Lame cutter / Odlamovací čepele / Odlamovací čepele / Lomljiva rezila / Laužomi peiliukai / Maināmie nolaužamie asmeņi / Vaibanoa terad / Отчуждающие осструета / Lomljene oštrice / Lomljene oštrice / Ανοσώμενες λεπίδες / Hojas segmentadas / Ricambio lame scorrevoli / Láminas curvadas / Lames coupées / Gebogen bladen

NEO TOOLS **x10** TITANIUM blade **0.4 mm** **3-PHASE CUT** **64HRC TITANIUM COATED**



Ref.	W [mm]	D [mm]	EAN
64-220	9	10/300	5907558400250

TOPEX **x10**



Ref.	W [mm]	D [mm]	EAN	
17B349	9	0,40	48/480	5902062140289
17B348	18	0,50	30/240	5902062140296

TOPEX **x5**



Ref.	W [mm]	D [mm]	EAN	
17B550	25	0,75	20/120	5902062141071

TOP TOOLS **x10**



Ref.	W [mm]	D [mm]	EAN
17B548	18	20/240	5902062140494

Ostrza trapezowe

Knife blades / Trapezklengen / Лезвия трапецевидные / Леза ножови / Törhető penge / Cutt lamă / Lichoběžníkové ostří / Ostrie lichoběžníkové / Nadomestna rezila / Keičiamos geležtės / Naža asmeņi / Noaterad / Осмупе резервно / Nožiči za skalpel / Nožici za skalpel / Ανταλλακτικές λεπίδες / Hojas trapezoidales / Ricambio lame fisse / Láminas de trapézio / Tranchants trapézoidaux / Trapezium mesbladen

NEO TOOLS **BLACK BLADE** **SK2 steel** **x10**



Ref.	W [mm]	EAN
64-015	10/240	5907558443578

NEO TOOLS **x5** **0.65 mm** **12mm**



Ref.	L [mm]	EAN	
64-410	52	10/300	5907558400267

NEO TOOLS **x5** **0.65 mm** **TITANIUM COATED**



Ref.	L [mm]	EAN	
64-420	52	10/300	5907558400274

TOPEX **x5**



Ref.	L [mm]	D [mm]	EAN	
17B405	51	0,40	0/500	5902062140302

Ostrza hakowe

Hook blades / Hackenklengen / Лезвия-крючки / Леза гакови / Törhető penge / Lame secară pentru cutter / Háková čepele / Hákové čepele / Kļjukasta rezila / Geležtē / Asmeņi-āķi / Konksterad / Осструета за куку / Kukaste oštrice / Kukasti noževi / Κοπίδι τάνητα / Hoja de gancho / Ricambio lame ad uncino / Láminas de anzol / Lames à crochets / Haakbladen

NEO TOOLS **x5** **0.5 mm**



Ref.	EAN	
64-610	10/300	5907558400281

NEO TOOLS **x5** **0.5 mm** **TITANIUM COATED**



Ref.	EAN	
64-620	10/300	5907558400298

TOPEX **x5**



Ref.	L [mm]	D [mm]	EAN	
17B2H5	51	0,65	60/600	5902062140739

Osełka

Whetstone / Schleifstein / Брусок точильный / Точила / Fenőkő / Pietră abrazivă / Brousek / Osla / Osla / Galastuvas / Galoda / Luisk / Брус / Brus / Πέτρα ακονίσματος / Taco de lijar / Pietra per affilare / Pedra de amolar / Pierre à aiguiser / Slijpsteen

NEO TOOLS



56-007

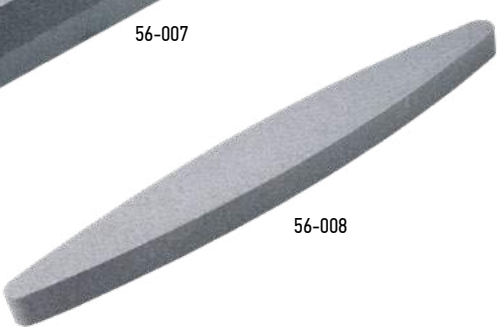

56-008

Ref.	W [mm]	L [mm]	H [mm]	gradacja	EAN	
56-007	50	150	25	K200/K100	25/50	5907558440232
56-008	35	230	13	K180	0/100	5907558440249

Maszynka do płytek ceramicznych

Tile cutting machine / Keramikfliesengerät / Плиткопоз / Плиткопоз / Csempevágó / Aparat pentru taiat plăci ceramice / Řezací stroj na keramické obkladačky / Rezačka na keramické obkladačky / Stroj za keramične ploščice / Keraminijų plytelių pjauštyklė / Fižu zažigis / Plaidilõikur keraamilistele plaatidele / Машина за фаянсови плочки / Uredaj za keramičke pločice / Mašina za keramičke pločice / Κόπτης πλακιδίων / Cortador de azulejos / Macchina taglia piastrelle / Máquina para azulejos cerâmicos / Machine de coupe de carrelages céramiques / Tegelsnijder voor ceramiek

NEO
TOOLS

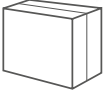

Ref.	L [mm]	☒	EAN
56-004	575	0/1	5907558408669
56-005	765	0/1	5907558408676

TOPEX

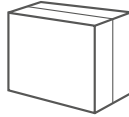
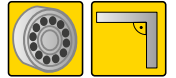

Ref.	L [mm]	☒	EAN
16B065	600	0/1	5902062091802
16B085	800	0/1	5902062091819

TOPEX

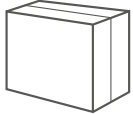
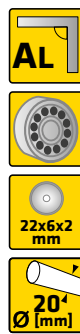

Ref.	L [mm]	W [mm]	☒	EAN
16B140	400	160	0/4	5902062220011
16B160	600	160	0/3	5902062220035

TOPEX

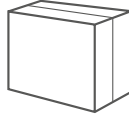

Ref.	L [mm]	W [mm]	☒	EAN
16B240	400	180	0/4	5902062091499
16B260	600	180	0/3	5902062091505

TOPEX

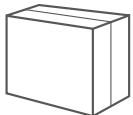

Ref.	L [mm]	☒	EAN
16B271	600	0/2	5902062092465
16B272	800	0/2	5902062092472
16B273	1000	0/2	5902062092489

TOPEX

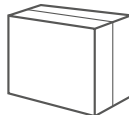
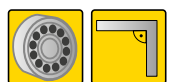

Ref.	L [mm]	☒	EAN
16B281	550	0/2	5902062000378
16B282	650	0/2	5902062000385

TOP TOOLS

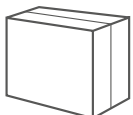

Ref.	L [mm]	W [mm]	☒	EAN
16B230	300	140	0/6	5902062091079

TOP TOOLS

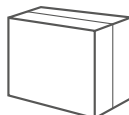
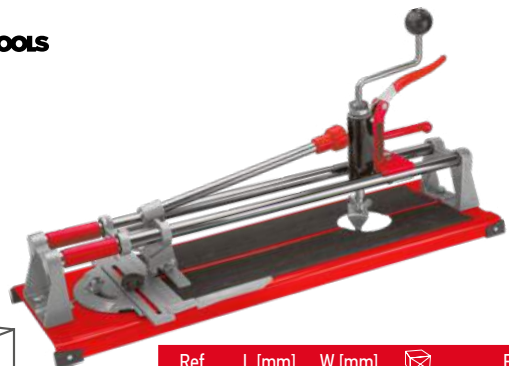

Ref.	L [mm]	W [mm]	☒	EAN
16B243	430	200	0/4	5902062090416
16B244	600	200	0/3	5902062092243

Kółko tnące

Cutting wheel / Schneiderad / Нож запасной / Ролун різучий / Csempévágókerék / Rezerva cutter tevi / Řezné kolečko / Koliesko na rezanie / Rezilno kolo / Pjovimo ratukas / Griezējirullis / Ketasnuga / Режуще колесо / Rezni kotačić / Тошак за rezanje / Ράουλο κοπής / Recambio rueda para cortatubos / Lama rotonda per taglia piastrelle / Roda cortante / Roue de coupage / Snijwiel

NEO
TOOLS

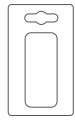

Ref.	ø [mm]	☒	EAN
56-006	16	0/50	5907558409932

TOPEX

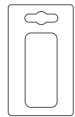

Ref.	L [mm]	Info	☒	EAN
16B328	22x5x2	16B270 - 16B273	10/250	5902062092663
16B330	22x10.5x2	16B280 - 16B282	10/500	5902062092670

TOPEX

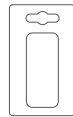

Ref.	Info	☒	EAN
16B316	do 16B230	10/400	5902062091246
16B318	do 16B240; 16B260	10/400	5902062091253
16B322	do 16B140; 16B160	10/300	5902062091260
16B324	do 16B055-16B085; 16B050-16B080	0/50	5902062204011
16B326	do 16B056-16B086	0/50	5902062205742

Wyciskacz do tub

Caulking gun / Auspresser für Tuben / Выжиматель / Топок для витиснання монтажноі піни / Kinyomópisztoly / Comprimator de tuburi / Aplikáční pistole na tuby / Vytlačáč túb / Pištola za tube / Hermetiko pistoletas / izspiedējs / Torulömmitis / Изтискивач за туби / Istiskivač za tube / Istiskivač za tube / Πιστόλι αλικόνης / Pistola para tubos / Pistola per cartucce / Espremedor para tubos / Pistolet pour tubes / Afdichtingspistool

NEO
TOOLS



Ref.	V [ml]	L [mm]	☒	EAN
61-005	310	254	0/12	5907558420838
61-006	600	389	0/12	5907558420845

NEO
TOOLS



Ref.	L [mm]	☒	EAN
61-001	240	0/24	5907558405842

NEO
TOOLS



Ref.	L [mm]	☒	EAN
61-002	240	0/12	5907558405859

NEO
TOOLS



Ref.	L [mm]	☒	EAN
61-003	240	0/12	5907558420814

NEO
TOOLS



3 trzpienie wyciskające
3 forcing pins
3 отжимных штифта

Ref.	L [mm]	☒	EAN
61-004	240	0/12	5907558420821

TOPEX



21B330-1

Ref.	V [ml]	☒	EAN
21B330	300	0/20	5902062213303
21B360	600	0/20	5902062213600
21B330-1	-	0/1000	5902062121783

Wyciskacz do tub

Caulking gun / Auspresser für Tuben / Выжиматель / Толок для витискування монтажноі піни / Kinyomópisztoly / Comprimator de tuburi / Aplikáční pistole na tuby / Vytlačáč túb / Pištola za tube / Hermetiko pistoletas / izspiedējs / Torutõmmits / Изтискувач за тубу / Istiskivač za tube / Istiskivač za tube / Πιστόλι σιλικόνης / Pistola para tubos / Pistola per cartucce / Espremedor para tubos / Pistolet pour tubes / Afdichtingspistool

T TOPEX



Ref.	☒	EAN
21B235	0/20	5902062120816

T TOPEX

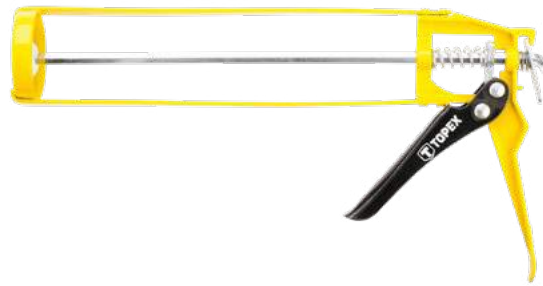

Ref.	☒	EAN
21B245	0/24	5902062120342

T TOPEX

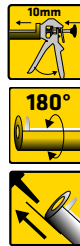

Ref.	☒	EAN
21B336	0/20	5902062121097

T TOPEX



Ref.	☒	EAN
21B438	0/30	5902062121080

TOP TOOLS

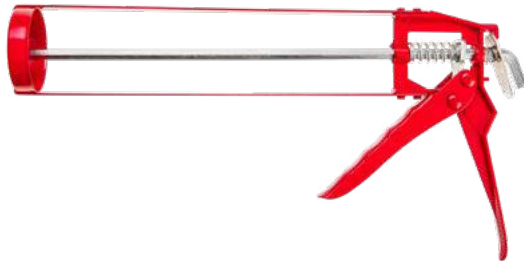

Ref.	☒	EAN
21B132	0/24	5902062009449

TOP TOOLS



Ref.	☒	EAN
21B131	0/24	5902062120335

Pistolet do pianki

Foam gun / Schaum-Pistole / Пистолет для пены / Пистолет до монтажноі піни / Habpisztoly / Pistol de spumă / Pěnová pistole / Aplikáční pištol' na penu / Pištola za peno / Montavimo putų pistoletas / Putu pistole / Vahuripistol / Пистолет за пяна / Pištolj za rjenu / Pištolj za penu / Πιστόλι αφρού / Pistola surtidora de espuma / Pistola per schiuma / Pistola p. espuma / Pistolet à mousse / Schuimpistool

NEO TOOLS

PTFE adapter
Переходник из PTFE

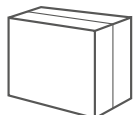

Ref.	☒	EAN
61-011	0/12	5907558409123

NEO TOOLS

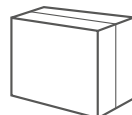

Ref.	☒	EAN
61-012	0/20	5907558412222

Pistolet do pianki montażowej

Foam gun / Schaumpistole / Пистолет для монтажной пены / Пистолет до піни монтажної / Kinyomópisztoly porhabhoz / Pistol p/u spumă de montare / Pistole pro montážní pěnu / Pištol na montážnu penu / Pištola za montažno peno / Pistoletas sandarinimo putoms / Montāžas putu pistole / Paigaldusvahu pūstol / Пистолет за полууряна / Pištolj za pur pjenu / Pištolj za pur penu / Πιστόλι αφοού μονταρίματος / Pistola surtidora de espuma / Pistola per schiuma / Pistola p. espuma de montagem / Pistolet à mousse de montage / Pistoal voor montageschuim

NEO
TOOLS

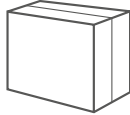

Ref. EAN
61-013 0/20 5902062009838

NEO
TOOLS

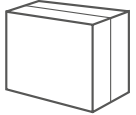

Ref. EAN
61-014 0/20 5902062009821

T TOPEX

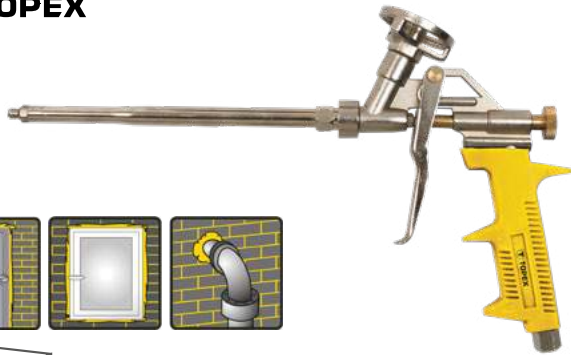
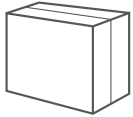
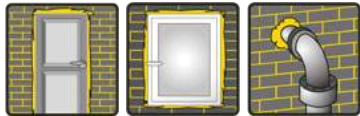

Ref. EAN
21B501 0/20 5902062215017

T TOPEX

PTFE adapter
Переходник из PTFE

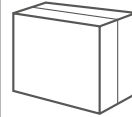
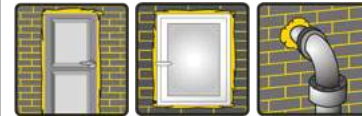

Ref. EAN
21B504 0/20 5902062215048

T TOPEX

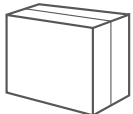
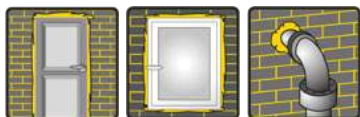

Ref. EAN
21B507 0/20 5902062009807

PTFE

TOP TOOLS

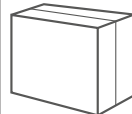

Ref. EAN
21B503 0/20 5902062215031

Pistolet do pianki

Foam gun / Schaum-Pistole / Пистолет для пены / Пистолет до монтажної піни / Habpiztoly / Pistol de spumă / Pěnová pistole / Aplikáčná pištol na penu / Pištol za peno / Montavimo putų pistoletas / Putu pistole / Vahuripistol / Пистолет за пяна / Pištolj za pjenu / Pištolj za penu / Πιστόλι αφοού / Pistola surtidora de espuma / Pistola per schiuma / Pistola p. espuma / Pistolet à mousse / Schuimpistoal

TOP TOOLS



Ref. EAN
21B510 0/100 5902062035714

TOP TOOLS

PTFE adapter
Переходник из PTFE

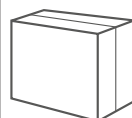

Ref. EAN
21B509 0/12 5902062011183

Skrobak

Scraper / Kratzer / Скребок / Шерехебень / Ablakkaparó / Ráztaoare / Škrábák / Škrabka / Strgalo / Grandiklis / Skrāpis / Kaabits / шабър / Strugaljka / Spahtla / Ξύστρα / Rasqueta / Spatola / Rascador / Grattoir / Krabber

TOPEX

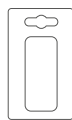

Ref.	L [mm]	W [mm]	⊠	EAN
18B526	310	100	0/96	5902062092229

TOP TOOLS

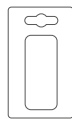

Ref.	L [mm]	W [mm]	⊠	EAN
18B550	145	51	120/360	5902062140326

Szczypce do glazury

Tile cutting pliers / Fliesenzange / Клещи для плитки / Щипци для плитки глазураної / Paragárfogó / Clește p/u plăci de teracotă / Kleště na glazuru / Kliešte rezacie a lámacie na obkladačky / Klešče za rezanje ploščic / Replés plyteléms / Knaibles fīzēm / Nāpītsad plaadi lāikamīseks / Клещи за фаянс / Klijesta za sječenje pločica / Klesta za secenje pločica / Σπάσης Πλακιδίων / Pinzas para azulejos / Pinza taglia piastrelle / Pinças p. azulejos / Pince à carrelage / Glazuurtang

TOPEX

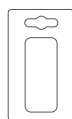

Ref.	L [mm]	⊠	EAN
16B440	200	6/36	5902062091482

TOPEX

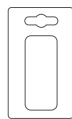

Ref.	L [mm]	⊠	EAN
16B441	200	5/50	5902062092212

TOPEX

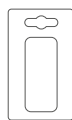

Ref.	L [mm]	⊠	EAN
16B430	210	0/60	5902062091277

TOPEX

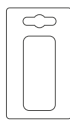

Ref.	L [mm]	⊠	EAN
16B471	210	10/60	5902062092045

Ostrza do skrobaka

Blades for scraper / Klingen für Schraber / Лезвия для скребка / Леза до скребка / Fugatisztábetét / Lame pentru razuitoir / Čepel na škrábku / Čepel na škrabky / Rezila za strgalo / Peiljai gremžtukui / Skrāpja asmeņi / Kraabitsa terad / Оструга за шабър / Oštrice za nožić / Oštrice za strugač / Lámes για ξύστρα / Hojas para rasqueta / Lame perraschietto / Lâminas p. Rascadora / Lames à grattoir / Krabberbladen

TOPEX



x10

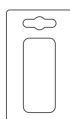

Ref.	L [mm]	⊠	EAN
18B527	100	24/192	5902062092236

TOPEX



x2

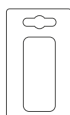

Ref.	⊠	EAN
16B471-1	0/400	5902062092205

Wycinarka otworów w glazurze

Adjustable hole cutter / Fliesenstichsäge / Сверло для плитки / Викружальник регульований / Kőrkinvágó csempéhez / Mecanizm de reglare perforare găuri / Fréza na díry v glazuře / Vykrúžovák na obkladačky / Urezovalec lukenj v ploščice / Prietaisais ertmių pjovimui plytelese / Caurumzāģis / Tellitav augulõikur / Буреля за фаянс / Podešavajuci Sječač / Sekas za rupe / Ρυθμιζόμενη Πένσα Πλακά / Sacabocado para azulejos / Fresa per piastrelle / Serra de contorno para azulejos / Découpeuse d'ouvertures dans le carrelage / Gatknipper voor glazuur

TOPEX

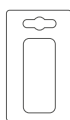
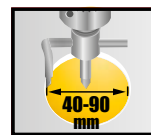

Ref.	Ø otvoru [mm]	⊠	EAN
16B460	40-90	0/50	5902062090270

TOPEX

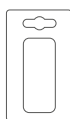
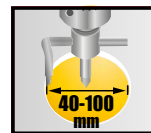

Ref.	Ø otvoru [mm]	⊠	EAN
16B451	40-100	3/36	5902062091536

TOP TOOLS

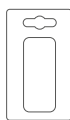

Ref.	Ø [mm]	⊠	EAN
16B450	10-50	6/36	5902062091475

Uchwyty magnetyczne do płytek

Magnetic tile holders / Magnetfliesenhalterungen / Держатели магнитные для плиток / Magnitu dla плитки / Mágneses csempe tartó / Dispozitiv magnetic fixare plăci / Magnetické držáky na obkládačky / Úchytky magnetické na obkládačky / Magnetna držala za ploščice / Magnetinis plytelių laikiklis / Turėtajs fizēm magnētisks / Magnetpladidhoicjād / Шнаперы за плочки / Magnetni Držac pločica / Magnetni drzac pločica / Μαγνητική θήκη συγκράτησης για πλακίδια / Plaquitas magnéticas de sujeción para azulejos / Supporto magnetica per piastrelle / Suportes magnéticos p. azulejos / Porte-plaquettes magnétiques / Magnetische houders voor tegels

TOPEX



x4

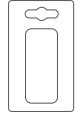

Ref.	☒	EAN
16B480	10/50	5902062202048

Kliny dystansowe

Tile wedges / Abstandskeile / Клинья / Клинци для плитки / Csempeék / Pene acoperiş / Distanční kliny / Klin distančný / Distančni klini / Pleiştai pyletels / Distances kılıs / Pladikiilud / Клинове / Klin za pločice / Klin za pločice / Σφιγές αποστασιοποίησης / Cuñas para azulejos / Distanziatori per piastrelle / Cunhas de distância / Cales d'entretoises / Afstandswiggen

TOPEX

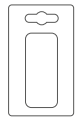

Ref.	W [mm]	N	☒	EAN
16B605	35	x50	0/100	5902062091345
16B610	28	x100	0/100	5902062091512

TOPEX

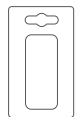

Ref.	W [mm]	N	☒	EAN
16B621	1	x100	0/100	5902062064226
16B622	1.5	x100	0/100	5902062064233
16B623	2	x100	0/100	5902062064240
16B624	3	x100	0/100	5902062064257
16B625	4	x100	0/100	5902062064264

TOPEX

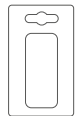

Ref.	W [mm]	N	☒	EAN
16B626	5	x50	0/100	5902062064271
16B627	6	x50	0/100	5902062064288
16B628	8	x50	0/100	5902062064295
16B629	10	x50	0/100	5902062064301

Krzyżki dystansowe

Cross distancers / Abstandskreuze / Крестики / Хресттики дистанційні / Hézagolókereszt / Cruciulijă p/u distanță / Distanční křížky / Křížik distančný / Distančni křížci / Krzyżki pyletels / Flizu krustij / Ristkiilud / Ограничител за флу / Křížci / Křtici / Αποστασιοποιητές πλακιδίων / Crucetas separadoras para azulejos / Distanziatori per piastrelle a croce / Separador / Entretoises de croix / Afstandskruizen

TOPEX

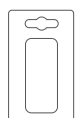

Ref.	W [mm]	N	☒	EAN
16B515	1.5	x200	0/100	5902062090348
16B514	1	x200	0/100	5902062064219
16B520	2	x200	0/100	5902062090355
16B525	2.5	x150	0/100	5902062090362
16B530	3	x150	0/100	5902062090379
16B540	4	x100	0/100	5902062090386
16B550	5	x100	0/100	5902062090393

Fugownica gumowa

Rubber spreader / Gummi-Fugengerät / Шпатель для фуговки / Шпадя гумова / Fugázógumi / Spaclu pentru rosturi / Stěrka pryžová / Gumená stěrka / Gumijasto orodje za fugiranje / Guminė glaistyklė, siūlėms / Gumijas lāpstiņa špaktelēšanai / Kummist vuugilabidas / Гумирана мапуна за фугуране / Gumeni stroj za fugiranje / Uredaj za širenje gume / Σπάτουλα ελαστική / Esparcidor con lengüeta de goma / Spatola riempigiunto / Máquina de pôr junta de borracha / Taloche pour joints en caoutchouc / Rubberen voegpistool

TOPEX



Ref.	L [mm]	☒	EAN
13A620	200	10/300	5902062091383
13A630	300	10/180	5902062091390

Klipsy do poziomowania płytek

Clips for system of quick tiles levelling / Clips zur Fliesennivellierung / Зажимы для выравнивания плитки / Клипы для вирівнювання нахлю / Lapszintező klipszek / Cleme pentru nivelarea plăcilor / Sprony pro nivelaci obkladů / Klipy na vyrovnávanie dlaždíc / Zagazde za keramične ploščice / Plytelių lyginimo klipai / Flizu limepošanas kļi / Plaatide loodimise klambriid / Скобы за нивелуване на плочки / Κορçe za niveliranje ploča / Isecci za izravnavanje ploča / Σφιγτήρες για αλφάδιασμα πλακιδίων / Elementos para nivel baldosas / Clip per il livellamento di piastrelle / Clipses para nivelamento de ladrilhos / Attaches pour mise à niveau de carrelages / Klemmen voor het nivellieren van tegels

NEO TOOLS



x150

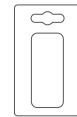

Ref.	W [mm]	N	☒	EAN
61-101	1.5	150	0/15	5907558454307
61-103	1	150	0/15	5907558458824

System poziomowania płytek

The system of quick tiles levelling / Fliesennivellierungssystem / Система для выравнивания плитки / Система вирівнювання нахлю / Lapszintező rendszer / Sistem de nivelare a plăcilor ceramice / Nivelacni systém pro obklady / System na vyrovnávanie dlaždíc / Sistem za niveliranje keramičnih ploščic / Plytelių lyginimo sistema / Flizu limepošanas sistēma / Plaatide loodimise sisteem / Система за нивелуване на плочки / Sustav za niveliranje ploča / Sistem za izravnavanje ploča / Σύστημα αλφάδιασμος πλακιδίων / Sistema para nivel baldosas / Sistema di livellamento per piastrelle / Sistema de nivelamento de ladrilhos / Système de mise à niveau de carreaux / Tegel nivelleer systeem

NEO TOOLS



x200

x100

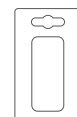

Ref.	W [mm]	N	☒	EAN
61-100	1.5	100+200	0/1	5907558454291
61-102	1	100+200	0/1	5907558458817



Pistolet do systemu poziomowania

Tile leveling plier / Fliesennivellierzange / Пистолет для системы выравнивания / Пистолет для системи вирівнювання / Pisztoły szintező rendszerhez / Pistol pentru sistemul de nivelare / Pistole pro nivelacni systém / Pištol na vyrovnávací systém / Klešče za niveliranje ploščic / Pistoletas išlyginimo sistamai / Limepošanas sistēmas pistole / Pistol tasandussüsteemii jaoks / Пистолет за система за нивелуване / Pištolj za sustav niveliranja / Pištolj za sistem niveliranja / Τανάλα για σύστημα αλφάδιοποίησης / Pistola para sistema de nivelación / Pistola per sistema di livellamento / Pistola para sistema de nivelamento / Pistolet pour système de nivellement / Pistool voor nivelleringssysteem

NEO TOOLS

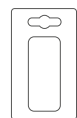

Ref.	☒	EAN
61-104	20/40	5907558459715

Walek do odpowietrzania wylewek

Deaeration roller / Welle zur Entlüftung von Fußböden / Валик изгольчатый для наливных полов / Валик голачастий (для наливных поверхностей) / Tűskés henger / Roló de evacuarea aerului/formatare sapa / Odvzdušňovací váleček / Valček na odvzdušňovanie / Valj za odzračevanje / Volelis nuorinimui / Adatu velnītis / Βετοοπιθουστρull / Иглен обезвъздушващ валик / Valjak za odzračivanje / Valjak za ventiliranje otvora / Roló αφαίρεσης φυσαλίδων / Rodillo anti-burbujas / Rullo frangibolle / Rolo para retirar ar / Rouleau à désaérer le mortier / Roller voor ontluchting van opstortingen

TOPEX



Ref.	L [mm]	wys. kolców [mm]	rodzaj	☒	EAN
20B801	250	14	drobny	0/15	5902062206077

Mieszadło do zapraw

Mortar mixer / Mörtelrührer / Мешалка для растворов / Мишалка до чамуру будівельного / Festékkeverőszer / Mixer ciment / Míchačka malty / Miesáč na maltu / Mešalnik za barvo / Maišyklė skiediniui / Mikseris massām / Mördisegisti / Бъркалка / Mikser za boju / Mikser za boju / Αναδευτήρας κονιάματος / Varilla para mezclador de mortero / Pala per miscelare la malta / Misturador p. Argamassa / Agitateur à mortier / Mortelmixer

NEO TOOLS

M14

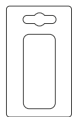

Ref.	L [mm]	☒	EAN
56-020	100	0/24	5907558440256
56-021	120	0/16	5907558440263

Mieszadło do zapraw

Mortar mixer / Mörtelrührer / Мешалка для растворов / Мишалка до чамуру будівельного / Festékkeverőszer / Mixer ciment / Míchačka malty / Miesáč na maltu / Mešalnik za barvo / Maišyklė skiediniui / Mikseris massām / Mördisegisti / Бъркалка / Mikser za boju / Mikser za boju / Αναδευτήρας κονιάματος / Varilla para mezclador de mortero / Pala per miscelare la malta / Misturador p. Argamassa / Agitateur à mortier / Mortelmixer

NEO TOOLS

SDS

NEO TOOLS

HEX

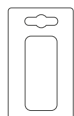

Ref.	L [mm]	☒	EAN
56-022	100	0/24	5907558440270
56-023	120	0/24	5907558440287

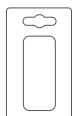

Ref.	L [mm]	☒	EAN
56-024	80	0/60	5907558440294
56-025	100	0/30	5907558440300

Mieszadło do gipsu

Plastering mixer / Gipsrührer / Мешалка для гипса / Мишалка до гіпсу / Festékkeverőszer / Mixer ghips / Míchačka sádry / Miesáč na sádru / Mešalnik za gips / Maišyklė gipsui / Mikseris gipsim / Krohvisegisti / Бъркалка / Mikser za boju / Αναδευτήρας σοβαντιάματος / Varilla para mezclador de yeso / Pala per miscelare il gesso / Misturador p. Gesso / Agitateur à plâtre / Gipsmixer

NEO TOOLS

HEX

NEO TOOLS

HEX

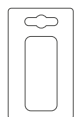

Ref.	L [mm]	☒	EAN
56-026	80	0/60	5907558440317
56-027	100	0/30	5907558440324

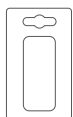

Ref.	L [mm]	☒	EAN
56-028	80	0/40	5907558440331
56-029	100	0/20	5907558440348

Taśmy uszczelniające do rur

Pipe sealing tapes / Dichtungsbänder für Rohre / Набор лент тефлоновых уплотнительных / Стрічки ущільнювальні тефлонові для труб / Csőtömítő szalagok / Banda izolatoare / Těsnící pásy pro trubky / Pásky tesniace na rúry / Tesnilni trakovi za cevi / Sandarinimo juostos, vamzdžiams / Teflona blivlentas kompleks / Isolatsioonilint torudele / Уплътнителна лента за тръби / Tračna brtvila za cijevi / Pričvršne trake za cevi / Σετ στεγανοποιητικών ταινιών teflon / Cintas de calafateo / Nastro sigillanti per tubi / Fitas vedantes p. tubos / Bandes d'étanchéité pour tubes / Afdichtingsbanden voor buizen

NEO TOOLS



Ref.	W [mm]	L [m]	N	☒	EAN
02-030	12	10	x5	100/200	5907558440355
02-031	12	10	x2	2/400	5907558440362

NEO TOOLS



Ref.	W [mm]	L [m]	☒	EAN
02-032	19	15	10/400	5907558440379

Taśma izolacyjna

Insulating tape / Isolierband / Лента изоляционная / Стрічка ізоляційна / Szigetelőszalag / Banda izolatoare / Izolační páska / Páska izolačná / Izolacijski trak / Izoliavimo juosta / Izolācijas lenta / Isoleerteip / Izolir traka / Ταβία μόνωσης / Nastro isolante / Fita de isolação / Bande isolante / Isolatieband

NEO
TOOLS



Ref.	W [mm]	L [m]	kolor	☒	EAN
01-528	15	10		0/500	5907558439335
01-526	15	10		0/500	5907558439311
01-529	15	10		0/500	5907558439342

TOP TOOLS



Ref.	W [mm]	L [mm]	kolor	☒	EAN
24B108	19	10		0/500	5902062130143
24B111	19	10		0/500	5902062130167
24B113	50	10		0/200	5902062130150

TOP TOOLS



x6

Ref.	W [mm]	L [mm]	☒	EAN
24B115	19	3	50/200	5902062130174

Taśma tynkarska

Masking tape / Putzband / Лента защитная для штукатурных работ / Стрічка захисна штукатурна / Takaró szalag / Bandă pentru tencuitor / de mascare, protectie / Páska na omítky / Páska na omietky / Trak za omete / Juosta tinkavimui / Aizsarglente armetuma darbiem / Maalriteip / Защитна лента за мазаческу роботу / Traka za žbuku / Molerske trake / Ταβία σοβαντίσματος / Cinta de enlucir / Nastro da carroziere / Fita de estuque / Bande de plâtrage / Stucadoorsband

NEO
TOOLS



Ref.	W [mm]	L [m]	☒	EAN
56-037	48	40	0/24	5907558446432

Taśma malarska

Masking tape / Malerband / Лента малярная / Стрічка малярська / Krepp szalag / Bandă de mascare / Malířská páska / Páska krycia / Zaštitni trak / Juosta dažyto darbams / Limlenta krăsoșanai / Maalriteip / Туксо хартиено / Krep traka / Krep traka / Ταβία κάλυψης / Cinta de pintor / Nastro maschera / Fita p. pintura / Bande de peinture / Verfband

NEO
TOOLS



Ref.	W [mm]	L [m]	☒	EAN
56-033	25	25	0/36	5907558446395
56-032	30	25	0/28	5907558446388
56-031	38	25	0/24	5907558446371
56-030	48	25	0/24	5907558446364

NEO
TOOLS



Ref.	W [mm]	L [m]	☒	EAN
56-036	30	40	0/28	5907558446425
56-035	38	40	0/24	5907558446418
56-034	48	40	0/24	5907558446401

TOPEX



Ref.	W [mm]	L [m]	☒	EAN
23B203	30	36	0/32	5902062121165
23B205	38	36	6/24	5902062232052
23B204	48	36	6/24	5902062121172

Taśma uniwersalna

Universal tape / Universalband / Лента универсальная / Стрічка універсальна / Ragasztószalag / Bandă universală / Univerzální páska / Páska lepíaca Univerzálna / Univerzalni trak / Universali juosta / Lenta universală / Universaalteip / Туксо армчрано / Univerzalna DUCT traka / Univerzalna traka / Ταβία γενικής χρήσης / Cinta universal reforzada DUCT TAPE / Nastro telato universale / Fita universal / Bande universelle / Universele band

TOPEX



Ref.	W [mm]	L [m]	☒	EAN
24B120	48	9	0/36	5902062241207
24B125	48	45	0/24	5902062241252

TOPEX



Ref.	W [mm]	L [m]	☒	EAN
23B222	50	10	0/36	5902062232229
23B224	50	25	0/24	5902062232243

Taśma naprawcza

Repair tape / Ремонтная лента / Ремонтна стрічка / Javitószalag / Repararea benzii / Páska opravná / Opravná páska

NEO
TOOLS



Ref.	W [mm]	L [m]	☒	EAN
56-040	48	20	0/24	5907558446463

Taśma pakowa

Packing tape / Packband / Скотч упаковочный / Шлифмашина стрічкова / Ragasztószalag / Bandă pentru ambalat / Balící páska / Baliača páska / Trak za pakiranje / Pakavimo juosta / Lesainpošanas lente / Pakkimesteip / Опаківочна лента / Traka za pakiranje / Traka za pakovanje / Κολλητική ταινία συσκευασίας / Cinta para embalar / Nastro da imballo / Fita especial / Bande d'emballage / Verpakingsband

NEO
TOOLS



Ref.	W [mm]	L [m]	☒	EAN
56-039	48	40	0/36	5907558446456

Taśma ostrzegawcza

Warning tape / Warnstreifen / Лента оградительная / Стрічка застережна / Jelölőszalag / Bandă de încălzire / Výstražná páska / Páska výstražná / Opozorilni trak / Įspėjamoji juosta / Drošības zonas lenta / Soojendusteip / Лента сигнальна / Traka za upozoravanje / Traka za upozoravanje / Αυτοκόλλητη Ταινία Προειδοποίησης Κινδύνου / Cinta de seguridad / Nastro segnaletico / Fita de advertência / Bande d'avertissement / Waarschuwingsband

TOPEX



Ref.	W [mm]	L [m]	☒	EAN
24B150	80	90	0/36	5902062241504

Nóż modelarski, 3 ostrza

Precision knife, 3 blades / Messer, 3 Klängen für Modellbauzwecke / Нож моделиста, 3 лезвия / Ніж моделіста, 3 леза / Dekorkés készlet / Cuijt de modelat, 3 lame / Modelářský nůž, 3 břity / Modelársky nôž, 3 čepele / Modelarski nož, 3 rezila / Modelavimo peilis, 3 geležtės / Modelēšanas nazis, 3 asmeņi / Hobinuga, 3 tera / Моделлерски нож, 3 остриета / Rezbarski nož, 3 oštrice / Modelarski nož, 3 oštrice / Μαχαίρι μοντελισμού, 3 λεπίδες / Cuchillo de precisión, 3 hojas / Coltello di precisione / Faca de modelação / Couteau de modelage / Precisie mes, 3 lemmeten

TOPEX

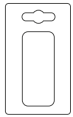

Ref.	L [mm]	☒	EAN
17B703	155	24/288	5902062141040

Nóż modelarski, 16 ostrzy

Precision knife, 16 blades / Messer, 16 Klängen für Modellbauzwecke / Нож моделиста, 16 лезвиў / Ніж моделіста, 16 лез / Dekorkés készlet / Cuijt de modelat, 16 lame / Modelářský nůž, 16 břity / Modelársky nôž, 16 čepele / Modelarski nož, 16 rezila / Modelavimo peilis, 16 geležtės / Modelēšanas nazis, 16 asmeņi / Hobinuga, 16 tera / Моделлерски нож, 16 остриета / Rezbarski nož, 16 oštrice / Modelarski nož, 16 oštrice / Μαχαίρι μοντελισμού, 16 λεπίδες / Cuchillo de precisión, 16 hojas / Coltello di precisione / Faca de modelação / Couteau de modelage / Precisie mes, 16 lemmeten

TOP TOOLS



x16

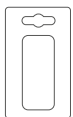

Ref.	N	☒	EAN
17B716	x16	0/100	5902062140333

TOPEX

24B121



24B122

Ref.	W [mm]	L [m]	☒	EAN
24B121	48	35	6/36	5902062241214
24B122	48	35	0/36	5902062130655

Nożyczki

Scissors / Schere / Ножницы / Ножуци / Olló / Foarfeca / Nůžky / Nožnice / Škarje / Žirkles / Šķēres / Käärid / Ножуци / Škarice / Μακάζι / Tijeras / forbice da elettricista / Tesoura / Ciseaux / Schaar

TOPEX



STAINLESS
STEEL



Ref.	L [mm]	☒	EAN
32D413	140	12/120	5902062007728

TOPEX



STAINLESS
STEEL

Hardened

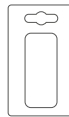

Ref.	L [mm]	☒	EAN
17B714	140	12/288	5902062177148
17B722	220	12/144	5902062177223

TOP TOOLS



Ref.	W [mm]	☒	EAN
17B721	215	12/144	5902062200020

TOP TOOLS



x3



Ref.	W [mm]	W [mm]	W [mm]	☒	EAN
17B723	140	160	210	10/40	5902062141095



OŚWIETLENIE
WORKSHOP LIGHTING **ОСВЕЩЕНИЕ**

Latarka

Torch / Taschenlampe / Фонарик / Ліхтарик / Alumínium 2az1-ben zseblámpa/vizsgólámpa / Lanterna / Baterka / Lampa / Svetilka / Žibintuvelis / Lukturis / Pöleti / Фенерче / Baterijska / lampa / Lampa / Φακός / Linterna de mano / Torcia / Lanterna / Torche / Zaklamp

NEO
TOOLS

3W 300 max lm	CREE XPE+COB LED	ALUMINIUM BODY	BATTERY Li-Ion 3.7V 2000mAh
3h charging	POCKET CLIP	small size	EDC compatible



ROTATING	USB charging	MAGNETIC
-----------------	------------------------	-----------------

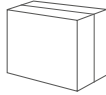

Ref. EAN
99-034 50/100 5907558451443

NEO
TOOLS

1st click:
 3% max 60 h

1st click:
 10% max 10 h

1st click:
 40% max 3 h

4th click: **OFF**
press 2 seconds:
 100%
max 45 sec.

double click:
 STROBE

30W 3300 max lm	BATTERY Li-Ion 3.7V 4000mAh	OSRAM P9 LED	220 m
ALUMINIUM BODY	USB charging cable	6h charging	IPX4

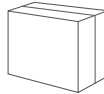

Ref. EAN
99-037 20/40 5907558451474

NEO
TOOLS

1st click:
 100% max 5 h

2nd click:
 50% max 10 h

3rd click:
 SIDE 100% max 5 h

4th click:
 SIDE STROBE

5th click: **OFF**

10W 800 max lm	BATTERY Li-Ion 3.7V 2000mAh	CREE T6+COB LED	USB charging cable	ALUMINIUM BODY
150 m	5h charging	IP20	small size EDC compatible	2in1

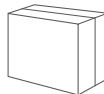

Ref. EAN
99-033 0/50 5907558451436

NEO
TOOLS

1st click:

100%
min 3 h

+ 1st click:

40%
max 7 h

+ 2nd click:

10%
max 25 h

2nd click:
OFF

click + hold:

STROBE

10W 1000 max lm	250 m	ZOOM	BATTERY Li-Ion 3.7V 2200mAh	OSRAM P9 LED
BATTERY INDICATOR	USB charging cable	IPX4	4.5h charging	

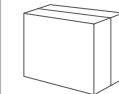

Ref. EAN
99-035 20/40 5907558451450

NEO
TOOLS

20W 1500 max lm	ALUMINIUM BODY	ZOOM	250 m	X6 AA	CREE XHP50.2 LED	3h work time
						IPX4

1st click: **100%**

2nd click: **OFF**

3rd click: **20%**

4th click: **OFF**

5th click: **SOS**
strobe

light press: **cycle modes**



Ref. EAN
99-036 4/24 5907558451467

NEO
TOOLS

100% 200lm
⌚ 2h
50% 100lm
⌚ 5h
stroboscope

ZOOM	CREE XP-E2	3W max 200lm	waterproof IPX7 30min	X3 AAA	ALUMINIUM BODY
-------------	----------------------	---------------------------	------------------------------------	------------------	--------------------------



Ref. EAN
99-101 12/72 5907558425482

Latarka

Torch / Taschenlampe / Фонарик / Ліхтарик / Aluminium 2x1-ben zseblámpa/vizsgálólámpa / Lanterna / Bateria / Lampa / Svetilka / Žibintuvelis / Lukturis / Pöleti / Фенерче / Baterijska / lampa / Lampa / Φακός / Linterna de mano / Torcia / Lanterna / Torche / Zaklamp

NEO
TOOLS



Ref. 99-046 8/96 EAN 5907558452372

NEO
TOOLS

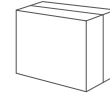

Ref. 99-032 0/75 EAN 5907558451306

1st click:

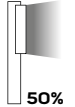

50%

2nd click:

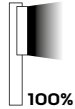

100%

3rd click:



RED STROBE

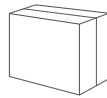

Ref. 99-045 50/100 EAN 5907558452365

TOP TOOLS



Ref. 94W380 12/144 EAN 5902062024176

Latarka czółowa

Headlamp / Stirnlampe / Фонарь налобный / Ліхтарик начільний / Fejlámpa / Lampă cap / Čelní baterka / Lampa čelová / Čelna svetilka / Žibintuvelis / Lukturitis uz pieres / Esilatern / Лампа за глава / Lampa za glavu / Rucna lampa / Φακός κεφαλής / Linterna de frente / Lampadina frontale / Lanterna de testa / Torche frontale / Hoofzáklamp

NEO
TOOLS

1st click:



40% max 2 h

2nd click:



10% max 6 h

3rd click: OFF

press 2 seconds:



100% max 40 sec.

double click:



STROBE

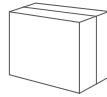

Ref. 99-027 10/80 EAN 5907558451252

NEO
TOOLS

1st click:



70% max 4 h

2nd click:



45% max 4 h

3rd click:

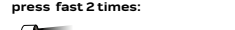

12% max 6 h

long press: OFF

press fast 2 times:



100% max 2.5 h

+ click 1: STROBE

+ click 2: SOS

long press: OFF

press 2 seconds:



Red

+ click 1: STROBE

+ click 2: Blue

long press: OFF



Ref. 99-028 0/50 EAN 5907558451269

NEO
TOOLS

1st click:



100% max 1.5 h

2nd click:

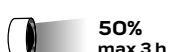

50% max 3 h

3rd click:



STROBE

4th click: OFF

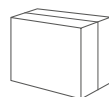

Ref. 99-026 56/112 EAN 5907558451245

NEO
TOOLS

1st click:



40% max 5 h

2nd click:

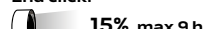

15% max 9 h

3rd click:



3% max 60 h

4th click: OFF

press 2 seconds:



100% max 40 sec.

double click:



STROBE



Ref. 99-029 10/40 EAN 5907558451276

Latarka czółowa

Headlamp / Stirnlampe / Фонарь налобный / Лихтарик начільний / Fejlámpa / Lampă cap / Čelní baterka / Lampa čelová / Čelna svetilka / Žibintuvelis / Lukturītis uz pieres / Esilatern / Лампа за глава / Lampa za glavu / Rucna lamp / Φακός κεφαλής / Linterna de frente / Lampadina frontale / Lanterna de testa / Torche frontale / Hoofdzaklamp

NEO
TOOLS

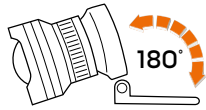

100% 400lm
⌚ 2h

50% 200lm
⌚ 5h

stroboscope

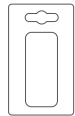

Ref. 99-200
EAN 10/40 5907558425505

NEO
TOOLS



100% 250lm
⌚ 3h

50% 125lm
⌚ 5h

stroboscope

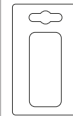

Ref. 99-201
EAN 0/40 5907558425710

T TOPEX

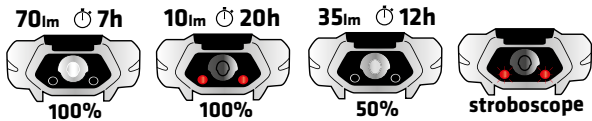

Ref. 94W390
EAN 12/48 5902062024190

T TOPEX

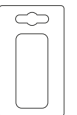

Ref. 94W391
EAN 12/48 590206205736

Lampa biwakowa

Camping lamp / Campinglampe / Лампа для кемпінга / Кемпінг лампа / Kemptinglámpa / Lampă de camping / Camping lamp / Camping lamp / Svetilka za kampiranje / Stovyklavimo lempa / Kempinga lamp / Matkalamp / Лампа за кемпинг / Svjetiljka za kampiranje / Лампа за камповање / Лампа кампинг / Lámpara de camping / Lampada da campeggio / Lámpada de acampamento / Lampe de camping / Camping lamp

NEO
TOOLS

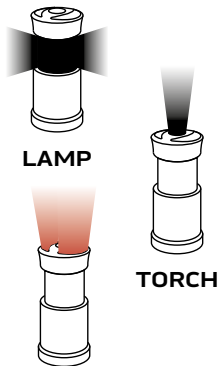

EMERGENCY
RED LIGHT

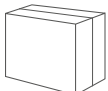

Ref. 99-030
EAN 0/40 5907558451283

NEO
TOOLS



1st click:
FRONT LIGHT
max 4 h

2nd click:
SIDE LIGHT
max 7 h

3rd click:
SIDE RED LIGHT
max 7 h

4rd click:
SIDE RED STROBE

Ref. 99-031
EAN 0/40 5907558451290

Naświetlacz

Floodlight / Scheinwerfer / Прожектор / Прожектор / Diszkvilágítás / Proiector / Světlo / Svetlomet / Reflektor / Projektorius / Floodlight / Floodlight / Прожектор / Reflektor / Φθοοδομηχ / Προβολέας / Luz de inundación / Proiettore / Floodlight / Projecteur / Schijnwerper

NEO
TOOLS



- 1st click: 100%
- 2nd click: 50%
- 3rd click: STROBE
- 4th click: OFF



Zasilane 3xAA lub 2x18650
Powered by 3xAA or 2x18650
Работает на 3xAA или 2x18650

Ref. 99-038 0/40 EAN 5907558452297

NEO
TOOLS



- 1st click: 100% max 3 h
- 2nd click: OFF
- 3rd click: 20% max 10 h
- 4th click: OFF
- 5th click: STROBE
- 6th click: OFF



Ref. 99-039 0/12 EAN 5907558452303

NEO
TOOLS



- 1st click: Large LED 100% max 2 h
- 2nd click: Small LED 100% max 5 h
- 3rd click: OFF
- press 3 seconds: Both LEDs 100% max 2 min



Ref. 99-040 10/20 EAN 5907558452310

Lampa warsztatowa

Workshop lamp / Werkstattlampe / Лампа переносная / Лампа переносна / Stekklámpa / Lampä atelier / Dilenská lampa / Dielenská lampa / Delavniška svetilka / Lampa dirbtuvams / Pārnesjamā lampa / Točkoka lampa / Лампа работна / Radna lampa / Radna lampa / Λάμπα εργαστηρίου / Lámpara de taller / Lampada da officina / Lâmpada de oficina / Lampe d'établi / Werkplaatslamp

NEO
TOOLS

- 1st click: 100% max 1.5 h
- 2nd click: 50% max 3 h
- 3rd click: 100% max 3 h
- 4th click: OFF
- press 2 seconds: RED LIGHT max 3 h
- + click 1: RED STROBE
- + click 2: OFF



Ref. 99-041 0/50 EAN 5907558452327

NEO
TOOLS

- 1st click: 100% max 2h
- 2nd click: 30% max 7h
- 3rd click: OFF



Ref. 99-043 0/24 EAN 5907558452341
Ref. 99-044 0/16 EAN 5907558452358

NEO
TOOLS

- 1st click: max 3.5 h
- 2nd click: OFF
- 3rd click: max 6 h
- 4th click: OFF

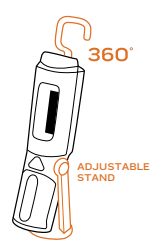

Ref. 99-042 0/24 EAN 5907558452334

Lampa warsztatowa

Workshop lamp / Werkstattlampe / Лампа переносная / Лампа переносна / Steklámpa / Lampă atelier / Dílenská lamp / Díelenská lamp / Delavniška svetilka / Lampa dirbtuvėms / Pārnēsājamā lamp / Töökoja lamp / Лампа работна / Radna lamp / Radna lamp / Λάμπα εργασιών / Lámpara de taller / Lampada da officina / Lámpada de oficina / Lampe d'atelier / Werkplaatslamp

NEO
TOOLS



Ref. 99-047
EAN 5907558452389

NEO
TOOLS

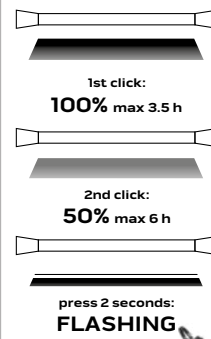

Ref. 99-048
EAN 5907558452396

T TOPEX

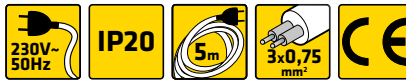

Ref. 94W213
P [W] 60
EAN 5902062942135

T TOPEX



Ref. 94W383
EAN 5902062024510

T TOPEX



Ref. 94W245
EAN 5902062942456

Lampa z czujnikiem ruchu

Lamp with motion sensor / Лампа с датчиком движения / Lampă cu senzor de mișcare / Lámpa mozgásérzékelővel / Лампа з датчиком руху / Svetilno so snimačem pohybu / Lampa se snimačem pohybu / Lampe mit Bewegungssensor / Svetilka s senzorjem gibanja / Lampa su judesio jutikliu / Lampa ar kustības sensoru / Liikumisanduriga lamp / Лампа със сензор за движение / Svjetiljka sa senzorom pokreta / Лампа са сензором покрета / Λάμπα με αισθητήρα κίνησης / Lámpara con sensor de movimiento / Lampada con sensore di movimento / Lámpada com sensor de movimento / Lampe avec détecteur de mouvement / Lamp met bewegingssensor

NEO
TOOLS



Ref. 99-049
P [W] 30
[lm] 2400
EAN 5907558452464

Ref. 99-050
P [W] 50
[lm] 5000
EAN 5907558452471

Lampa

Lamp / Lampe / Лампа / Лампа / Lámpa / Lampă / Lampa / Lampa / Svetilka / Lampa / Lampa / Lamp / Лампа / Lampa / Lampa / Lámpa / Lámpara / Lampada / Lámpada / Lampe / Lamp /

NEO
TOOLS

- SMD LED
- 230V 50Hz
- 30000h work time
- 6500 K
- ALUMINIUM BODY
- IP65
- BEAM ANGLE >100°
- CRI Ra≥70
- 60% <0.5s
- ON/OFF ≥15000
- CABLE 15cm
- NO DIMM
- 40° < >50°
- PF>0.8



Ref.	P [W]	[lm]	☒	EAN
99-051	20	1600	0/40	5907558452488
99-052	30	2400	0/30	5907558452495
99-053	50	4000	0/20	5907558452501
99-054	100	8000	0/10	5907558452518



NEO
TOOLS



- SMD LED
- 50W
- 4500 max lm
- 230V 50Hz
- CABLE 2m EU plug
- BEAM ANGLE >120°
- 6500 K
- 25000h work time
- 60% <1.0s
- ON/OFF ≥15000
- CRI Ra≥80
- PF>0.9
- 25° < >45°
- NO DIMM
- IP65

Ref.	P [W]	[lm]	☒	EAN
99-063	50	4500	0/10	5907558452600



NEO
TOOLS

- SMD LED
- H 1.8 m MAX
- 6500 K
- 25000h work time
- 230V 50Hz
- BEAM ANGLE >120°
- 60% <1.0s
- PF>0.9
- CRI Ra≥80
- CABLE 3m EU plug
- NO DIMM
- 25° < >45°
- ON/OFF ≥15000
- IP65



Ref.	P [W]	[lm]	☒	EAN
99-059	30	2700	0/4	5907558452563
99-060	50	4500	0/4	5907558452570



NEO
TOOLS



- 230V 50Hz
- SMD LED
- H 1.8 m MAX
- BEAM ANGLE >120°
- 6500 K
- 25000h work time
- 60% <1.0s
- PF>0.9
- 25° < >45°
- NO DIMM
- CRI Ra≥80
- CABLE 3m EU plug
- ON/OFF ≥15000
- IP65

Ref.	P [W]	[lm]	☒	EAN
99-061	2x 30	5400	0/4	5907558452587
99-062	2x 50	9000	0/4	5907558452594



Lampa solarna

Solar lamp / Солнечная лампа / Lampă solară / Napelemes lámpa / Солнечна лампа / Solárna lamp / Solární lamp / Solarlampe / Solárna lamp / Saulės lempa / Saules lamp / Päikeselamp / Стънчева лампа / Solarna lamp / Соларна лампа / Ηλεκτός λαμπτήρας / Lámpara solar / Lampada solare / Luminária solar / Lampe solaire / Zonne-lamp

NEO
TOOLS



Ref. 99-055 Ref. 0/50 EAN 5907558452525



NEO
TOOLS



Ref. 99-057 Ref. 0/30 EAN 5907558452549



NEO
TOOLS



Ref. 99-058 Ref. 0/16 EAN 5907558452556



Žarówka halogenowa

Halogen bulb / Halogenlampe / Лампочка галогенная / Лампочка галогенна / Halogén izzó / Vec halogen / Halogenová žárovka / Halogenová žiarovka / Halogena žarnica / Halogeninė lempuė / Halogēna spuldze / Halogeennirn / Лампа халогенна / Halogena sijalica / Halogena sijalica / Λαμπτήρας αλογόνου / Bombilla halógena / Lampadina alogena / Lámpada de halogênio / Ampoule halogène / Halogeennlamp

TOPEX



Ref. 94W601 P [W] 120 Ref. 50/500 EAN 5902062208774



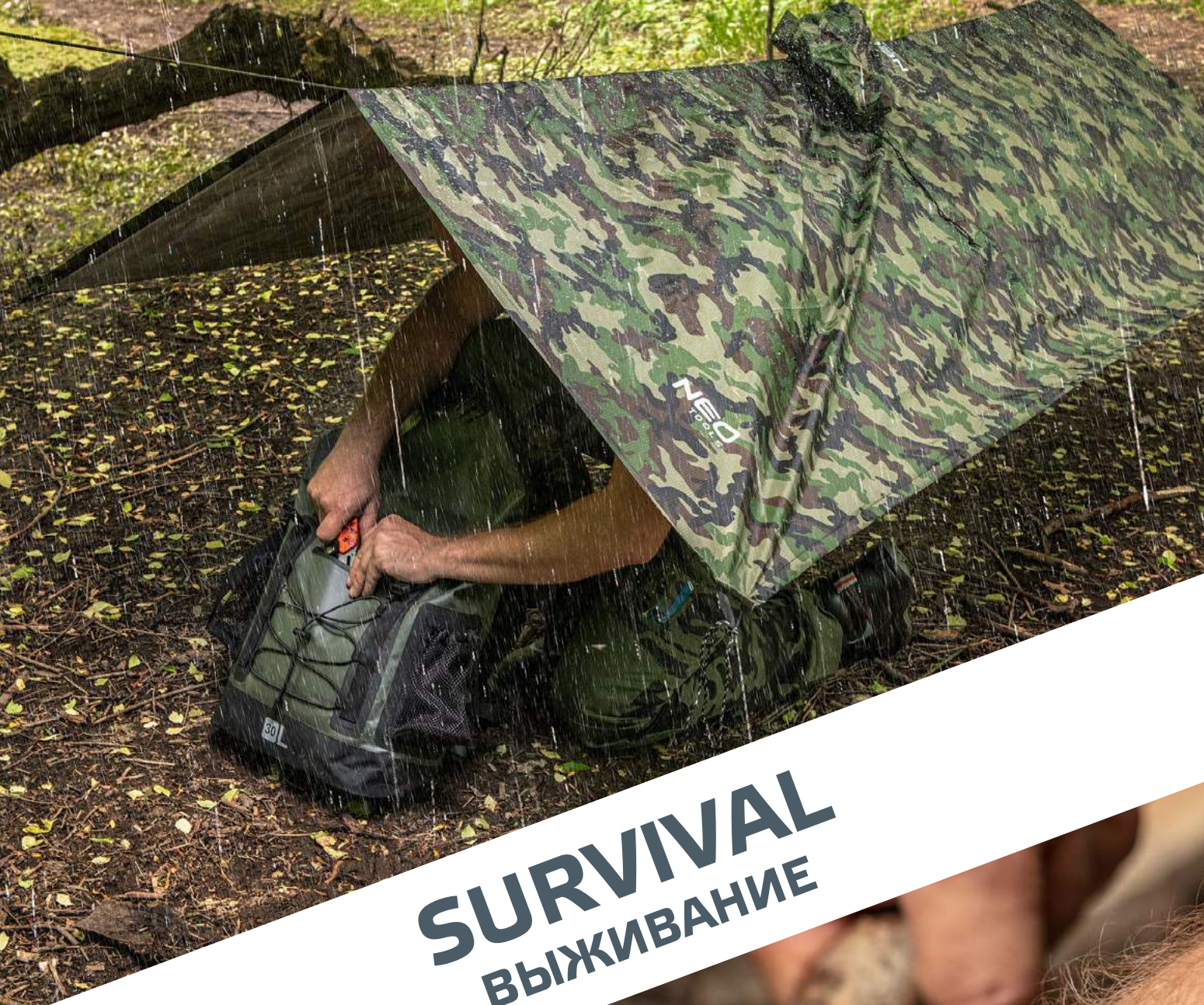

SURVIVAL

ВЫЖИВАНИЕ



Bransoletka survivalowa

Survival bracelet / Überlebensarmband / Браслет выживания из паракорда / Браслет выживания / Túléltő karkötő / Brățară de supraviețuire / Outdoor náramek – survival / Náramek na prežitie / Zapestnica za preživetje / Išgyvenimo aryrankė / Izdzīvošanas aprīce / Ellujäämise käevõru / Гръвна за оцеляване / Наруквица за preživljavanje / Наруквица за preživljavanje / Βραχιόλι επιβίωσης / Pulseira de supervivencia / Braccialetto di sopravvivenza / Pulseira de sobrevivência / Bracelet de survie / Survival armband

NEO
TOOLS



5in1

- paracord rope
- flint
- compass
- knife
- whistle

PARACORD

FLINT

Ref. 63-140 capacity [kg] 6/48 EAN 5907558454222

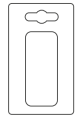

Gwizdek

Whistle / Pfeifen / Свисток / Свисток / Síp / Fluiet / Piskat / Pišťalka / Pišťalka / Svípkukas / Svíple / Vile / Свирка / Звиздати / Звиздък / Συριζα / Silbar / Fischio / Apito / Sifflet / Fluiten

NEO
TOOLS



7in1

- Whistle
- LED light
- Compass
- Thermometry
- Mirror
- Magnifying glass
- Mini storage tank

NECK CORD

Ref. 63-139 capacity [kg] 12/144 EAN 5907558454215

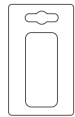

Lina paracord

Paracord rope / Paracord Seil / Паракорд / Канат Paracord / Paracord kötél / Frånghie Paracord / Paracordové lano / Paracordové lano / Cuerda de paracord / Corda Paracord / Corde Paracord

NEO
TOOLS



PARACORD

30 m

4mm

Ref. 63-125 capacity [kg] 400 EAN 5907558454079

Niezbędnik

Survival kit / Grundlagen / Базовый набор для выживания / Базовий набір для виживання / Túléltőcsomag 11 az 1-ben / Elementele esențiale / Základní informace / Základné informácie / Bistvenega pomena / Esminis / Būtiski / Oluline / От съществено значение / Bitno / Суштински / Ουσιαστικός / Esenciales / Essentials / Essencials / Essentiel / Essentiële zaken

NEO
TOOLS



11in1

- K nife
- Can opener
- S crewdriver
- Fire starter
- Wrench
- Compass
- Magnifying glass
- S stainless steel tweezers
- Plastic spatula
- Rope
- Whistle

Ref. 63-133 capacity [kg] 24/144 EAN 5907558454154

Etui wodoodporne na telefon

Waterproof case for the phone / Wasserdichte Hülle für das Telefon / Водонепроницаемый чехол для телефона / Водонепроникний чохол для телефону / Vízálló tok a telefonhoz / Husă pentru telefon rezistentă la apă / Vodotěsné pouzdro na telefon / Vodotesné puzdro na telefon / Funda impermeable para el teléfono / Custodia impermeabile per il telefono / Boîtier étanche pour le téléphone

NEO
TOOLS



100% WATER PROOF

PVC + ABS

6.2" max

CALLING

IPX8

TOUCH

Ref. 63-135 capacity [kg] 50/200 EAN 5907558454178

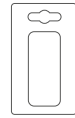

Karabińczyk

Snap hook / Cliphaken / Карабин / Карабин / Karabiner / Carabinieră / Clip háček / Karabin / Gancho de clip / Moschetone / Crochet à clip

NEO
TOOLS



NOT FOR CLIMBING

CAPACITY 20 kg

7.5 cm

Ref. 63-138 capacity [kg] 0/500 EAN 5907558454208

Taśmy do hamaków

Hammock webbing / Hängemattenbänder / Ленты для гамаков / Стрички для гамаків / Szalagok függőágyhoz / Benzi pentru hamace / Новаці паськы / Popruhy na hamak / Cintas para hamacas / Nastroj per amache / Rubans hamac

NEO
TOOLS



x2

2.5 m

CAPACITY 300 kg

15 HOLES

Ref. 63-141 capacity [kg] 0/50 EAN 5907558454239

Karta przetrwania 11 w 1

Survival card 11 in 1 / Überlebenskarte 11 in 1 / Карта выживания 11 в 1 / Картка виживання 11 в 1 / Túléltési kártya 11 az 1-ben / Card de supraviețuire 11 în 1 / Karta prežití 11 v 1 / Karta prežitia 11 v 1 / Tarjeta de supervivencia 11 en 1 / Carta di sopravvivenza 11 in 1 / Carte de survie 11 en 1

NEO
TOOLS

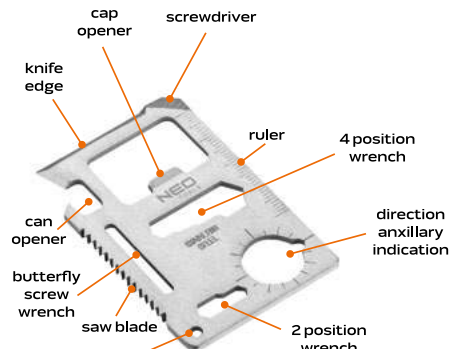

11in1

STAINLESS steel

+ direction auxiliary indication

Ref. 63-134 capacity [kg] 0/144 EAN 5907558454161

Kuchenka survivalowa

Survival stove / Überlebenskocher / Плита для выживания / Плита для выживания / Tűléllé fűző / Aragaz survival / Sporák na přežití / Survival varič / Cocina de supervivencia / Fornello da sopravvivenza / Cuisseur de survie

NEO
TOOLS



FOLDING
CONSTRUCTION

STAINLESS
steel

369g

16
cm

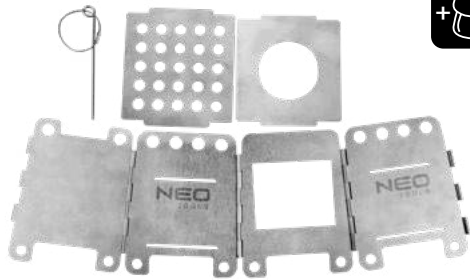

Ref. 63-126 EAN 5907558454086

Hamak, zestaw

Hammock kit / Hängematte Set / Гамак, комплект / Гамак, комплект / Fűggőágy, készlet / Hamac, set / Sada houpačí síťe / Hamak, súprava / Conjunto Hamaca / Amaca, set / Ensemble hamac

NEO
TOOLS



SET
INCLUDES:
-1 x hammock
-1 x bag
-2 x tapes
-2 x clip hook

EXTRA
LONG
330 x
140 cm

MAX
200
kg

Ref. 63-124 EAN 5907558454062

Tarp wodoodporny

Tarp, kit with hooks and cords / Wasserdichte Plane / Тент, комплект + крючки, веревки / Тент, комплект + гачки, мотузки / Ponyva, készlet + kampók, kötelek / Prelatá adápost, set + cãrlige, frãngãii,

NEO
TOOLS



SET
INCLUDES:
-1x tarp
-4x hooks
-6x ropes
-2x bags

x6

210T
POLIESTER

360
x
290
cm

Ref. 63-130 EAN 5907558454123

Palnik gazowy turystyczny

Camping gas burner / Touristischer Gasbrenner / Газовая горелка туристическая / Газовый палник туристичный / Turista gázégő / Arzător pe gaz turistic / Turistický plynový hořák / Turistický plynový horák / Quemador de gas turístico / Bruciatore a gas turistico / Brûleur à gaz touristique

NEO
TOOLS



nozzle type
EN 417

STAINLESS
steel

3000
W

140
g/h

103g

123
x80
mm

MAX
CAPACITY
5kg

MAX DIA
20cm

Ref. 63-128 EAN 5907558454109

Hamak z moskitierą, zestaw

Bug-screened hammock kit / Hängematte mit Moskitonetz Set / Гамак с москитной сеткой, комплект / Гамак з москитною сіткою, комплект / Rovarháló s függőágy, készlet / Hamac cu plasă antinsecte, set / Houpačí síť s moskytiérou, sada / Hamak so sieťou proti hmyzu, súprava / Conjunto hamaca con mosquitera / Amaca con zanzariera / Ensemble hamac avec moustiquaire

NEO
TOOLS



SET
INCLUDES:
-1 x hammock
-1 x mosquito net
-1 x bag
-2 x tapes
-2 x ropes
-2 x clip hook

MOSQUITO
NET

EXTRA
LONG
330 x
140 cm

MAX
200
kg

Ref. 63-123 EAN 5907558454055

Peleryna przeciwdeszczowa

Rain poncho / Regenmantel / Дождевик / Дощовик / Esőálló körgallér / Pelerină de ploaie / Pláštěnka / Pelerina-pršiplášt / Impermeable / Mantello impermeabile / Imperméable

NEO
TOOLS



3in1
-p oncho
-tarp
-mat

210D
POLYESTER

CUFF
BUTTONS

Ref. 63-132 EAN 5907558454147

Narzędzie wielofunkcyjne

Multipurpose tool / Allzweckwerkzeuge / Инструмент универсальный / Инструмент багатofункційний / Multiszerszám / Unealta multifuncionala / Multifunkční nástroj / Viacfunkčné náradie / Večfunkcijsko orodje / Daugafunkciniai įrankiai / Daudzfunkcionālie instrumenti / Multifunktsionaalne tööriist / Мультифункционален инструмент / Višenamjenski uređaj / Višefunkcionalne alatke / Πολυεργαλείο / Herramienta multiuso / Utensile multiuso / Aparelho multifunções / Outil multifonction / Multifunctioneel gereedschap

NEO
TOOLS

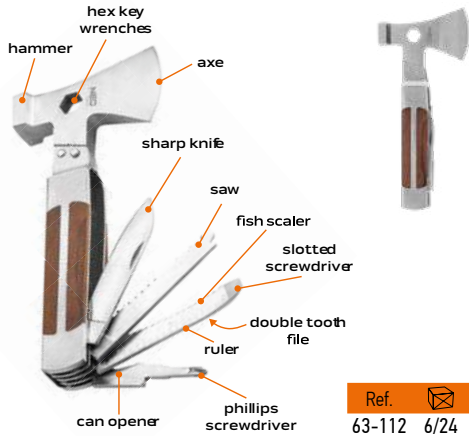

11in1

STAINLESS
steel



Ref. EAN
63-112 6/24 5907558453591

NEO
TOOLS

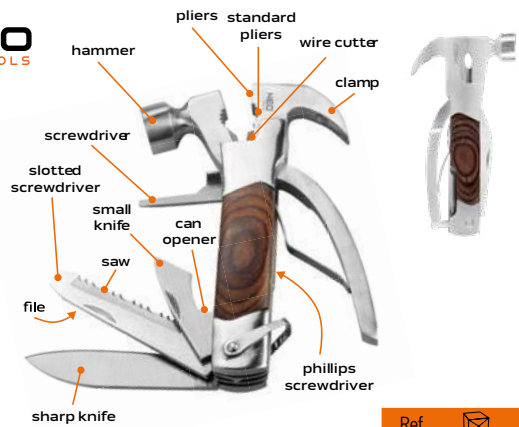

13in1

STAINLESS
steel



Ref. EAN
63-113 6/48 5907558453607

NEO
TOOLS



LED
light

ALUMINIUM
BODY

**10
in 1**



Ref. W [mm] EAN
01-027 105 6/48 5907558420944

NEO
TOOLS



2xLED
light

ALUMINIUM
BODY

**7
in 1**



Ref. W [mm] EAN
01-025 155 6/36 5907558420920

NEO
TOOLS



LED
light

ALUMINIUM
BODY

**12
in 1**



Ref. W [mm] EAN
01-026 155 6/36 5907558420937

NEO
TOOLS



ALUMINIUM
BODY

**11
in 1**



Ref. W [mm] EAN
01-028 150 6/36 5907558420951

Nóż

Knife / Messer / Нож / Hibx / Kés / Çuqit / Nůž / Nôž / Nož / Peilis / Nazis / Nuga / Макемен нож / Noz / Μαχαίρι / Coltello / Faca / Couteau / Mes

NEO
TOOLS

**215
mm**

STAINLESS
steel

PP+TPR
HANDLE

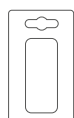

Ref. EAN
63-105 6/24 5907558453522

NEO
TOOLS

**FULL
TANG**

**165
mm**

STAINLESS
steel

TPR
HANDLE

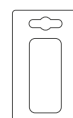

Ref. EAN
63-106 6/48 5907558453539

Nóż

Knife / Messer / Нож / Хиҷ / Kés / Cutit / Nůž / Nůž / Nož / Peilis / Nazis / Nuga / Макемен нож / Noz / Μαχαίρι / Coltello / Faca / Couteau / Mes

NEO
TOOLS

220
mm



BLADE
9cm

420
STAINLESS
steel

6in1

- K nife
- W histle
- F ire starter
- W ranch
- S afe bet cutter
- G lass breaker

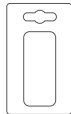

Ref. 63-107 12/72 EAN 5907558453546

FULL
TANG

250
mm

STAINLESS
steel

BAMBOO
HANDLE



TITANIUM
FINISH

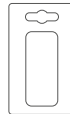

Ref. 63-110 6/24 EAN 5907558453577

Nóż składany

Folding knife / Messer zusammenklappbar / Нож складной / Хиҷ складной / Összecsukható tőr / Briceag pliabil / Skládací nůž / Skladací nůž / Zložljiv nož / Sulankstomas peilis / Saliekamais nazis / Kokkukäiv nuga / Нож сгъваем / Sklopiv nož / Nož na sklanjanje / Μαχαίρι πτυσσόμενο / Cuchillo plegable / Coltello a serramanico / Faca dobrável / Couteau pliable / Vouwmes

NEO
TOOLS

BALL
BEARING
ASSISTED
OPENING

180
mm

BLADE
8cm

440ss
STAINLESS
steel

NEO
TOOLS

220
mm

STAINLESS
steel

SS +
ROSEWOOD
HANDLE



TITANIUM
FINISH

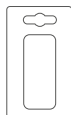

Ref. 63-114 12/72 EAN 5907558453614

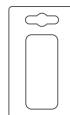

Ref. 63-115 6/24 EAN 5907558453621

NEO
TOOLS

440
steel
blade

TITANIUM
BODY



NEO
TOOLS

440
steel
blade

ANODIZED
ALUMINIUM
BODY



Ref. 63-025 6/48 EAN 5907558420968



Ref. 63-026 6/48 EAN 5907558420975

Nóż uniwersalny

Knife / Universalmesser / Нож универсальный / Хиҷ Трапéзpengés összecsukható kés / Cutit / Univerzální nůž / Nůž univerzálný / Nož / Universalus peilis / Nazis / Nuga / Ножче / Džepni nožić / Noz / Μαχαίρι γενικής χρήσης / Cuchillo universal / Taglierino a lama fissa / Faca universal / Couteau universel / Universele mes

NEO
TOOLS

FULL
TANG

BLADE
12cm

230
mm

420
STAINLESS
steel



NEO
TOOLS

FULL
TANG

240
mm

STAINLESS
steel

PAKKA
WOOD
HANDLE



TITANIUM
FINISH

BOTTLE
OPENER



Ref. 63-111 12/48 EAN 5907558453584



Ref. 63-116 6/24 EAN 5907558453638

Nóż uniwersalny

Knife / Universalmesser / Нож универсальный / Нож / Trapézpengés összecusukható kés / Cuțit / Univerzální nůž / Nóż univerzálny / Nož / Universatus peilis / Nazis / Nuga / Ножиче / Džepni nožić / Noz / Μαχαίρι γενικής χρήσης / Cuchillo universal / Tagliarino a lama fissa / Faca universal / Couteau universel / Universele mes

NEO
TOOLS



Ref. EAN
63-108 6/24 5907558453553

NEO
TOOLS



Ref. EAN
63-109 12/48 5907558453560

Scyzoryk biwakowy

Camping knife / Taschenmesser / Нож перочинный туристический / Нож туристичний багатафункційний / Zsebkés / Briceag camping / Kapesní nůž pro kempování / Vreckový nožík turistický / Žepni nož za kampiranje / Kišeninis peiliukas, stovyklautojui / Saliekamais tūrista nazis / Matka-taskunuga / туристическо джесовно ножиче / Švicarski džepni nož / Nož za kampiranje / Πολυεργαλείο τουριστικό / Navaja suiza de acampada / Cotellino multiuso / Canivete de bivaque / Couteau bivouac / Bivak zakmes

NEO
TOOLS



Ref. EAN
63-027 6/48 5907558420982

Maczeta

Machete / Machete / Мачете / Мачете / Machete / Machete / Mačeta / Mačeta / Mačeta / Machete / Mačete / Machete / Мачете / Mačeta / Мачета / Μεγάλη / μαχαίρα / Machete / Machete / Machete / Machette / Machete

NEO
TOOLS



Ref. EAN
63-117 6/24 5907558453997

Piła ręczna bushcraftowa

Bushcraft hand saw / Säge Hand Bushcraft / Ручная пила для бущкрафта / Ручна пила для бущкрафта / Bushcraft kézfűrés / Ferástráu de mâná bushcraft / Viděl ruční bushcraft / Bushcraftová ruční píla / Sierra manual bushcraft / Seghetto manuale da bushcraft / Scie à main bushcraft

NEO
TOOLS



Ref. EAN
63-120 12/72 5907558454024



Siekiera

Axe / Axt / Topor / Сокира / Balta / Topor / Sekera / Sekera / Sekira / Kirvis / Cirvis / Kirves / Брџаџа / Sjekira / Sekira / Τσεκούρι / Hacha / Scure / Machado / Hache / Bijl

NEO
TOOLS

26
cm

STAINLESS
steel

PARACORD
HANDLE

WRIST
STRAP

TITANIUM
FINISH

WRENCH
10 / 13 / 16
mm



Ref. 63-118 6/24 EAN 5907558454000

Saperka składana

Folding army shovel / Klappschaufel / Лопата сапёрная складная / Лопата саперна складна / Összehajtható gyalogsági ásó / Lopatä pliable / Skládaci lopata / Lopata krátka skladaná / Pala plegable / Pala militare pieghevole / Pelle pliante

NEO
TOOLS



6in1
• shovel
• pickaxe
• bottle
opener
• saw
• wrench

FOLDING
CONSTRUCTION

10mm
SCREW



Ref. 63-121 0/20 EAN 5907558454031

Plecak taktyczny

Tactical backpack / Taktischer Rucksack / Тактический рюкзак / Тактичний рюкзак / Szerszámos hátizsák / Rucsac tactic / Taktický batoh / Taktični nahrbtnik / Taktinė kuprinė / Taktiskä mugursoma / Taktikaline seljakott / Такмическа раница / Taktički ruksak / Такмички раница / Тактико σακίδιο πλάτης / Mochila táctica / Zaino tattico / Mochila táctica / Sac à dos tactique / Tactische rugzak

NEO
TOOLS

HEAVY
DUTY
10kgs.



18 kieszeni wewnętrznych
18 inside pockets
18 внутренних карманов



4 kieszenie zewnętrzne
4 outer pockets
4 наружных кармана



Ref. 84-321 0/6 EAN 5907558444155

Toporek bushcraftowy w futerale

Bushcraft hatchet with sheath / Axt Bushcraft in einem Fall / Topor для бушкрафта в чехле / Сокира для бушкрафта в чохлах / Bushcraft fejsze tokban / Topor bushcraft în husă / Axe Bushcraft v pouzde / Bushcraftová sekerka v puzdre / Bushcraft hacha en un estuche / Assetta da Bushcraft in custodia / Hache bushcraft dans un étui

NEO
TOOLS

400
g

WOODEN
HANDLE

LEATHER
POUCH

C55
STEEL



Ref. 63-119 0/10 EAN 5907558454017

Saperka multifunkcyjna

Multifunctional shovel / Klappschaufel / Многофункциональная лопата / Лопата саперна складна / Összehajtható gyalogsági ásó / Lopatä pliable / Skládaci lopata / Lopata krátka skladaná / Pala plegable / Pala militare pieghevole / Pelle pliante

NEO
TOOLS



8in1
• shovel
• saw
• pickaxe
• bottle
opener
• file
• multifunction
knife
• safety
hammer
• whistle

FOLDING
CONSTRUCTION

MAX
LENGTH
63cm



Ref. 63-122 0/20 EAN 5907558454048

Torba turystyczna

Tourist bag / Touristentasche / Туристическая сумка / Туристична сумка / Turista táska / Geantă turistică / Turistická taška / Turistická taška / Turistična torba / Turistinis krepšys / Turistu soma / Turistikott / Туристическа чанта / Turistička torba / Туристичка торба / Τουριστική τσάντα / Bolsa de turista / Borsa turistica / Mala de turista / Sac touristique / Toeristentas

NEO
TOOLS

HEAVY
DUTY



8 kieszeni wewnętrznych
8 inside pockets
8 внутренних карманов



14 kieszeni zewnętrznych
14 outer pockets
14 наружных кармана



Ref. 84-322 0/6 EAN 5907558444186

Torba turystyczna

Tourist bag / Touristentasche / Туристическая сумка / Туристична сумка / Turista táska / Geantă turistică / Turistická taška / Turistická taška / Turistična torba / Turistinis krepšys / Turistu soma / Turistkott / Туристическа чанта / Turistička torba / Туристична торба / Туристичкі таўна / Bolsa de turista / Borsa turistica / Mala de turista / Sac touristique / Toeristentas

NEO
TOOLS

HEAVY
DUTY



4 kieszenie zewnętrzne
4 zip fastened outer pockets
4 наружных кармана



4 kieszenie wewnętrzne
4 inside pockets
4 внутренних кармана



Ref. 84-323
0/35
EAN 5907558444179

Saszetka

Waist bag / Gürteltasche / Поясная сумка / Торба на паску / Ersény / Borseta / Ledvinka / Ladvinka / Pasma torbica / Deklas / Jostas soma / Vöökott / Папаска / Pasma torbica / Torbica / Τσαστάκι μέσης / Riñonera / Marsupio / Bolsa / Sacoche porte-outils à ceinture

NEO
TOOLS

HEAVY
DUTY



2 pojemne komory główne
Two spacious main compartments
2 удобных главных отдела



3 kieszenie wewnętrzne
3 inside pockets
3 внутренних кармана



Ref. 84-324
0/70
EAN 5907558444162

Plecak turystyczny

Outdoor backpack / Reiserucksack / Туристический рюкзак / Туристичний рюкзак / Turista hátizsák / Rucsac turistic / Cestovní batoh / Náramok na prežitie / Zaino turistico

NEO
TOOLS

30L

15
kg

600D

HEAVY
DUTY



Ref. 84-325
0/8
EAN 5907558455311

Plecak survivalowy

Survival backpack / Überlebensrucksack / Рюкзак для выживания / Рюкзак для виживання / Tútlélő hátizsák / Rucsac survival / Batoh na přežití / Náramok na prežitie / Zaino da sopravvivenza

NEO
TOOLS

40L

20
kg

600D

4in1



Ref. 84-326
0/12
EAN 5907558455328

Plecak wodoodporny

Water-proof backpack / Wasserdichter Rucksack / Водонепроницаемый рюкзак / Водонепроникний рюкзак / Vízálló hátizsák / Rucsac impermeabil / Vodotěsný batoh / Vodovzdorný batoh / Mochila impermeable / Zaino impermeabile / Sac à dos étanche

NEO
TOOLS

30L

WATER
PROOF

32
x
63
x
18
cm

600D
PVC



Ref. 63-131
0/6
EAN 5907558454130





DOM I GARAZ
HOUSE AND GARAGE **ДОМ И ГАРАЖ**

Wentylator

Fan / Fan / вентилатор / вентилятор / ventilátor / ventilator / větrák / vetrák / Ventilator / Ventilatorius / Ventilators / Ventilator / Вентилятор / Ventilator / Πεσζα / Ανεμιστήρας / Admirador / Fan / Fan / Ventilateur

NEO
TOOLS



- 50W
- Ø 40 CM
- 3 AIRFLOW SPEEDS
- L R
- COPPER MOTOR



Ref. 90-001 EAN 5907558442717

NEO
TOOLS



- 45W
- Ø 40 CM
- TIMER 0,5 - 7,5 h
- REMOTE CONTROL
- 3 AIRFLOW SPEEDS
- L R
- NORMAL/ SLEEP/ NATURA
- COPPER MOTOR

Ref. 90-002 EAN 5907558442724

NEO
TOOLS



- 100W
- Ø 45 CM
- 3 AIRFLOW SPEEDS
- L R
- HEAVY DUTY
- EXTRA POWER
- COPPER MOTOR

Ref. 90-003 EAN 5907558442731

NEO
TOOLS

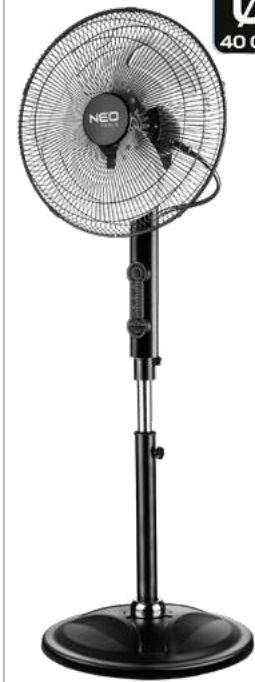

- 80W
- Ø 40 CM
- HEAVY DUTY
- L R
- REMOTE CONTROL
- 3 AIRFLOW SPEEDS
- NORMAL/ SLEEP/ NATURA
- TIMER 0,5 - 7,5 h
- EXTRA POWER
- ALUMINIUM
- COPPER MOTOR

Ref. 90-004 EAN 5907558442731

NEO
TOOLS



- 50W
- Ø 30 CM
- 3 AIRFLOW SPEEDS
- METAL BODY
- COPPER MOTOR

Ref. 90-005 EAN 5907558442755

NEO
TOOLS

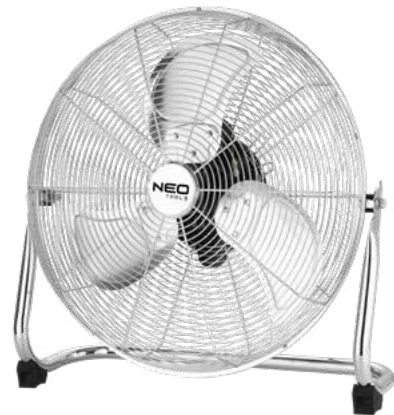

- 111W
- Ø 45 CM
- 3 AIRFLOW SPEEDS
- METAL BODY
- COPPER MOTOR

Ref. 90-006 EAN 5907558442762

NEO
TOOLS



- 111W
- Ø 45 CM
- 3 AIRFLOW SPEEDS
- METAL BODY
- 360°
- COPPER MOTOR

Ref. 90-007 EAN 5907558442779

NEO
TOOLS



- 100W
- Ø 50 CM
- 3 AIRFLOW SPEEDS
- 360°
- METAL BODY
- COPPER MOTOR
- HEAVY DUTY
- IP44

Ref. 90-008 EAN 5907558442786

Promiennik

Infrared heater / Heizkörper / Радиатор / Radiator / Radiator / Radiator / Radiator / Infrarødeci grelec / Infraraudonijų spindulių šildytuvas / Infrasarkanais sildītājs / Infrapuna kütteseade / Инфракрасен нагревател / Infracveni grijač / Инфрацрвени грејач / Υπέρθερμη θερμάστρα / Calentador de infrarrojos / Riscaldatore a infrarossi / Infrarood verwarming / Chauffage infrarouge

NEO
TOOLS

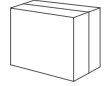

Ref. 90-030 EAN 5907558447415

NEO
TOOLS

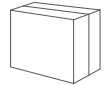

Ref. 90-031 EAN 5907558447422

NEO
TOOLS

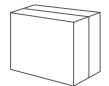

Ref. 90-032 EAN 5907558447439

NEO
TOOLS

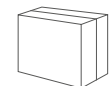

Ref. 90-033 EAN 5907558447453

NEO
TOOLS



Ref. 90-034 EAN 5907558447453

NEO
TOOLS

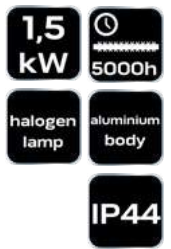

Ref. 90-037 EAN 5907558457889

NEO
TOOLS



Ref. 90-038 EAN 5907558457896

NEO
TOOLS

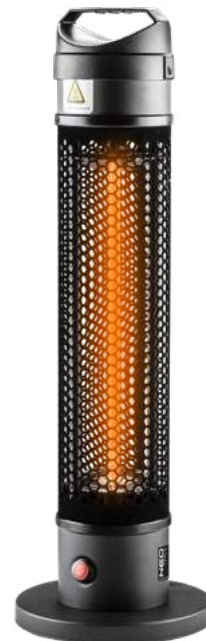

Ref. 90-035 EAN 5907558447460

Promiennik

Infrared heater / Heizkörper / Ραδιатор / Ραδιатор / Radiátor / Radiator / Radiátor / Radiator / Infrardeči grelec / Infraraudonųjų spindulių šildytuvas / Infrasarkanais sildītājs / Infrarūna kütteseade / Инфрарчервен нагревател / Infracrveni grijač / Инфрацрвени грејач / Υπέριθρη θερμάστρα / Calentador de infrarrojos / Riscaldatore a infrarossi / Infrarood verwarming / Chauffage infrarouge

NEO
TOOLS



Ref. EAN
90-036 0/1 5907558457872

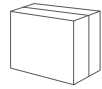

Statyw

Tripod / Stativ / Штатив / Штатив / Hárómlábú / Trepied / Stativ / Stativ / Stojalo / Trikojjs / Stativs / Stativ / Статив / Τρονοζαc / Τρονοζαc / Τρίποδο / Tripode / Treppiedi / Statief / Trépied

NEO
TOOLS

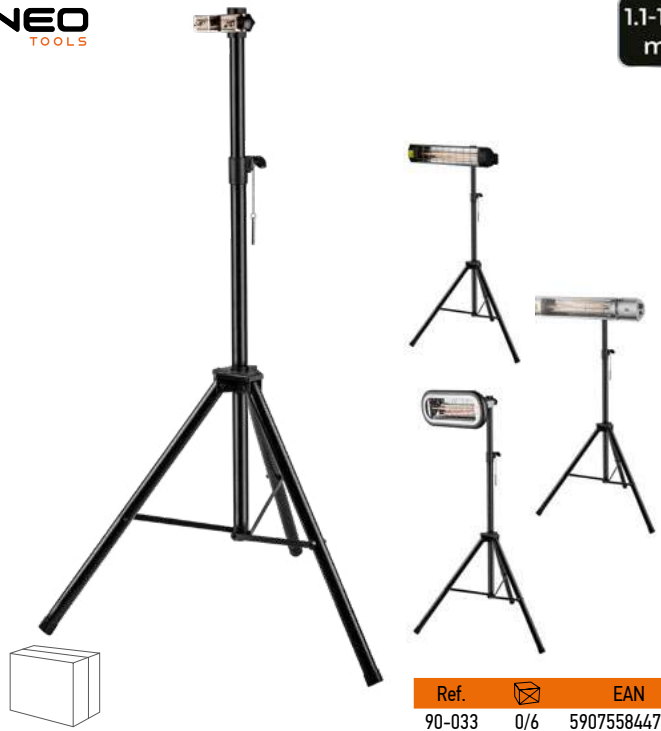

1.1-1.8
m

Ref. EAN
90-033 0/6 5907558447446



Nagrzewnica

Electric heater / Elektrische Heizung / Электрический нагреватель / Электричний обігрівач / Hősugárzó / Incalzitör electric / Elektrický ohřivač / Elektrický ohrievač / Električni grelec / Elektrinis šildytuvas / Elektriskais sildītājs / Elektrikeris / Elektricheski nagrevatel / Električni grijač / Električni greјач / Ηλεκτρική θερμάστρα / Calentador eléctrico / Stufa elettrica / Elektrische verwarming / Chauffage électrique

NEO
TOOLS



Ref. P [kW] [m³/h] EAN
90-060 2 139 0/1 5907558447477
90-061 3 210 0/1 5907558447484

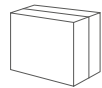

NEO
TOOLS



Ref. P [kW] [m³/h] EAN
90-062 2 197 0/8 5907558447491
90-063 3 280 0/1 5907558447507
90-064 5 588 0/1 5907558447514



NEO
TOOLS



Ref. P [kW] [m³/h] EAN
90-065 2 253 0/1 5907558447521
90-066 3 291 0/1 5907558447538

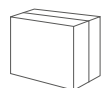

NEO
TOOLS



Ref. P [kW] [m³/h] EAN
90-067 2 330 0/1 5907558447545
90-068 3 354 0/1 5907558447552
90-069 5 366 0/1 5907558447569



Nagrzewnica

Electric heater / Elektrische Heizung / Электрический нагреватель / Elektrický obíhričov / Hőszugárzó / Incalzitor electric / Elektrický ohřivač / Elektrický ohrievač / Električni grelec / Elektrinis šildytuvas / Elektriskais sildītājs / Elektrikeris / Электрически нагревател / Električni grijač / Električni grejač / Ηλεκτρική θερμάστρα / Calentador eléctrica / Stufa elettrica / Elektrische verwarming / Chauffage électrique

NEO
TOOLS

MANUAL



2400W

2 in 1



Ref.	P [kW]	[m³/h]	☒	EAN
90-070	2,4	460	0/4	5907558447576

NEO
TOOLS

DIGITAL



2400W

2 in 1



Ref.	P [kW]	[m³/h]	☒	EAN
90-071	2,4	460	0/4	5907558447583

Nagrzewnica olejowa

Oil heater / Ölheizung / Масляный нагреватель / Масляний нагрівач / Olajmelegítő / Încalzitor cu ulei / Ohřivač oleje / Ohrievač oleja / Grelnik olja / Alyvos šildytuvas / Eļļas sildītājs / Ölikkütteseade / Нагревател на масло / Grijač ulja / Грејач уља / Θερμαντήρας λαβίου / Calentador de aceite / Riscaldatore dell'olio / Olie warmer / Réchauffeur d'huile

NEO
TOOLS

20 kW

DIESEL OIL / KEROSENE

550 m³/h

19 l



Ref.	P [kW]	[m³/h]	☒	EAN
90-080	20	550	0/1	5907558457919

NEO
TOOLS

DIESEL OIL / KEROSENE



Ref.	P [kW]	[m³/h]	l	☒	EAN
90-081	30	750	34	0/1	5907558457926
90-082	50	1100	50	0/1	5907558457933

Nagrzewnica gazowa

Gas heater / Gasheizung / Газовый обогреватель / Газовий обігрівач / Gázmelegítő / Incalzitor pe gaz / Plynový ohřivač / Plynový ohrievač / Plinski grelec / Dujinis šildytuvas / Gāzes sildītājs / Gaasikütteseade / Газов нагревател / Plinski grijač / Гасни грејач / Θερμαντήρας αερίου / Calentador a gas / Stufa a gas / Gaskachel / Chauffage à gaz

NEO
TOOLS

GAS heater

PIEZO



Ref.	P [kW]	[m³/h]	[bar]	☒	EAN
90-083	15	580	0,7	0/1	5907558457940
90-084	30	1000	0,7	0/1	5907558457957
90-085	50	1000	1,5	0/1	5907558457964



Grzejnik

Heater / Heizgerät / Ηεζεαηελ / Ηεζεαα / Elektromos fűtőpanel / Radiator / Ohřívaa / Ohřevaaa / Grelec / Šildytuvaa / Sildītājs / Soojendi / Ηεζεααηηη / Grijaa / Γρεαα / Ηεμάρηηη / Calentador / Riscaldatore / Kachel / Chauffe-eau

NEO
TOOLS

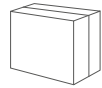

Ref.	P [W]	☒	EAN
90-090	1000	0/1	5907558447590
90-091	1500	0/1	5907558447606
90-092	2000	0/1	5907558447613

NEO
TOOLS

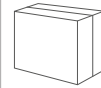

Ref.	P [W]	☒	EAN
90-093	1000	0/1	5907558447620
90-094	1500	0/1	5907558447637
90-095	2000	0/1	5907558447644

NEO
TOOLS

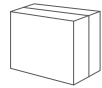
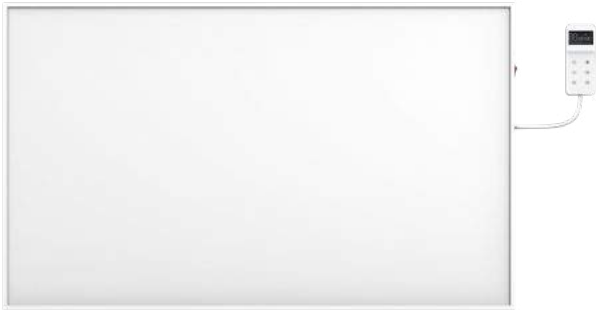

Ref.	P [W]	☒	EAN
90-096	450	0/1	5907558447651
90-097	600	0/1	5907558447668
90-098	720	0/1	5907558447675

NEO
TOOLS

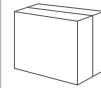
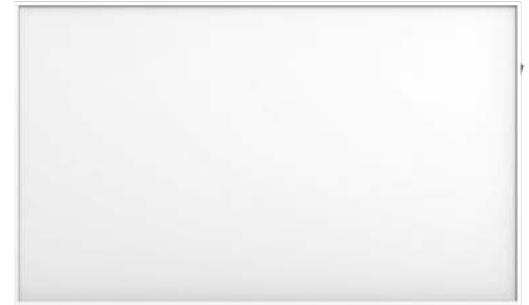

Ref.	P [W]	☒	EAN
90-099	450	0/1	5907558447682
90-100	600	0/1	5907558447699
90-101	720	0/1	5907558447705

NEO
TOOLS

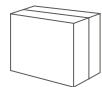
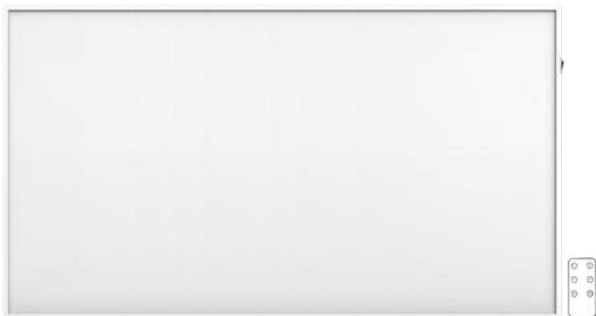

Ref.	P [W]	☒	EAN
90-102	450	0/1	5907558461695
90-103	600	0/1	5907558461701
90-104	720	0/1	5907558461718

NEO
TOOLS

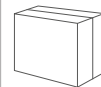
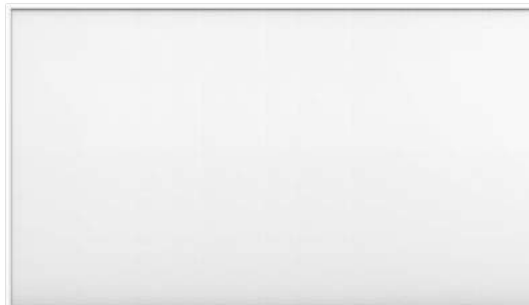

Ref.	P [W]	☒	EAN
90-105	450	0/1	5907558461725
90-106	600	0/1	5907558461732
90-107	720	0/1	5907558461749

Wspornik sufitowy

Ceiling bracket / Deckenhalterung / Потолочный кронштейн / Кронштейн для стел / Mennyezeti konzol / Support de tavan / Stropní držák / Stropná konzola / Stropní nosič / Lubų laikiklis / Griestu kronšteins / Laekinnitus / Скоба за таван / Stropní nosaa / Стропни носaa / Βάση οροφής / Sororte de techo / Staffa a soffitto / Plafondbeugel / Support de plafond



NEO
TOOLS

For panels: 90-102/90-103/ 90-104 / 90-105 / 90-106 / 90-107

Ref.	☒	EAN
90-108	0/1	5907558462326
90-108-1	0/1	5907558462432

Nogi

Feets / Füße / Hozu / Hozu / Édességék / Picioare / Nohy / Feety / Stopala / Saldainiai / Saldumi / Maiustused / Крانا / Stopala / Стонана / Πόδια / Pies / Feets / Voeten / Pieds

NEO
TOOLS



For panels: 90-102/90-103/ 90-104 / 90-105 / 90-106 / 90-107

Ref.	☒	EAN
90-109	0/1	5907558462333

Oczyszczacz powietrza

Air purifier / Luftreiniger / Устройства очистки воздуха / Пристрій очищувача повітря / Légtisztító készülék / Dispositiv de purificare a aerului / Zařízení na čištění vzduchu / Zariadenie na čistenie vzduchu / Naprava za čiščenje zraka / Oro valymo įtaisas / Gaisa attīrīšanas ierīce / Ὀδωρῆστασεαδὲ / Устройство за пречиштане на въздух / Uredaj za pročišćavanje zraka / Уредјай за пречишћавање ваздуха / Συσκευή καθαρισμού αέρα / Dispositivo purificador de aire / Dispositivo purificatore d'aria / Luchtreiniger / Dispositif de purificateur d'air

NEO
TOOLS



K112945



Filters more than 99% of bacteria, virus, dust etc.



Ref.	⊞	EAN
90-121	0/4	5907558451016
K112945	0/12	5902062063564

NEO
TOOLS



K112946



Filters more than 99% of bacteria, virus, dust etc.

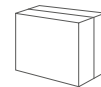

Ref.	⊞	EAN
90-122	0/2	5907558451023
K112946	0/12	5902062063571

NEO
TOOLS



K112948



Filters more than 99% of bacteria, virus, dust etc.



K112950

K112951



Ref.	⊞	EAN
90-125	0/1	5902062062758
K112948	0/1	5902062063595
K112951	0/1	5902062063618
K112950	0/1	5902062063601

NEO
TOOLS



K112947



Filters more than 99% of bacteria, virus, dust etc.



K112950

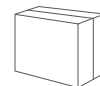

Ref.	⊞	EAN
90-127	0/1	5902062062772
K112947	0/1	5902062063588
K112950	0/1	5902062063601

Lampa UVC dezynfekująca

UVC lamp / UVC-Lampe / УФ-лампа / УФ-лампа / UVC lámpa / Lampă UVC / UVC lamp / UVC lamp / UVC svetilka / UVC lempa / UVC lamp / UVC лампа / UVC lamp / УБЦ лампа / Lámpara UVC / Lampada UVC / UVC-lampe / Lampe UVC /

NEO
TOOLS



NEO
TOOLS



Ref. 90-130 0/6 EAN 5907558454338

Ref. 90-131 0/6 EAN 5907558454345

Ref. 90-132 0/50 EAN 5907558454352

Rozpalarka do grila

Grill Ignitor / Grillanzünder / Термопистолет для розжигания барбекю / Запальничка для гриля / Elektromos grillgyújtó / Aprinzător de grătar / Zapalovač grilů / Zapalovač na gril / Fen na vroč zrak / Orarūte grillui / Grila aizdedzinātājs / Grillisüütaja / Электронна запалка за грил / Уралjač за roštilj / Уралjač за roštilj / Βερροπιστολο για άναμμα μπάρμπεκιου / Mechero para barbacos / Accenditore elettrico / Acendedor de carvão para churrasco / Allume-barbecue / Barbecue aansteker

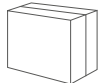

Ref. 51G510 0/10 EAN 5902062013644

Szkló powiększające

Magnifying glass / Lupă / Увеличительное стекло / Збільшувальне скло / Nagytó / Vergrößerungsglas / Lupa / Zväčšujúce sklo / Povečevalno steklo / Didinamasis stiklas / Palielinošais stikls / Suurendusklaas / Лупа / Povečalo / Lupa / Μεγεθυντικός φακός / Lupa / Lente ingrandimento / Lente de aumento / Loupe / Vergröttingsglas

TOPEX

3
dpt

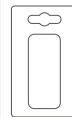

Ref. 79R290 ø [mm] 90 12/120 EAN 5902062023865

Podkładki filcowe

Adhesive felt pad set / Filzunterlagen / Подкладки фетровые / Підкладки вовстинні / Bútorcsúsztató filc / Mašlinā de cosit gazoane / Plstěné podložky / Filcové podložky / Podložke iz filca / Minkštu veltinių tarpiklių komplektas / Filca palīkņi / Nakvun vildāpolstri komplekt / Filc samolepljivi / Συλλογή ντουκάχαρτων / Almohadillas de fieltro protectoras de suelo, adhesivas / Tappetini di feltro adesivi / Calços de feltro / Rondelles à feutre / Vilt onderlagen

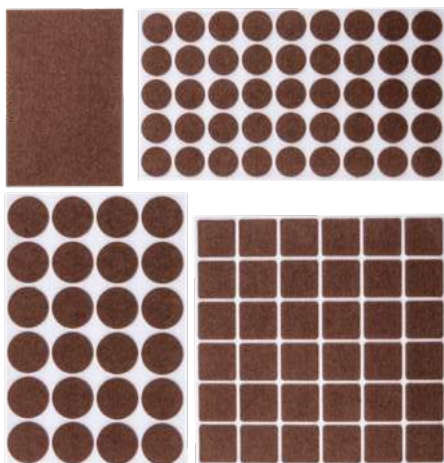

x106

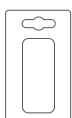

Ref. color 0/96 EAN
98Z146 0/96 5902062230317
98Z147 0/96 5902062230324





VERTO

SPRAYING MACHINE
OPRYSKIWACZ CIŚNIENIOWY
ОПРЫСКИВАТЕЛЬ

1,5 L 15G502



OGRÓD
GARDEN САД



NEO
TOOLS

Zraszacz pistoletowy

Water spray gun / Sprühpistole / Spritze / Опрыскатель пистолетный / Опрыскувач пістолетний / Üntözö piztolý / Pistol de stropire / Postřikovací pistole / Pištoľový postrekač / Brizgalna pištola / Purkštukas - pistoletas / Laistīšanas pistole / Pūstoļ-pihustusotsak / Пустолет струйник / Raspršivač na pištoľ / Pištoľ prskalica / Εκτοξευτής νερού πιστόλι / Aspersor tipo pistola / Irrigatore a pistola / Pistola de aspersão / Arroiseur à pistolet / Slangkoppeling STOP

NEO
TOOLS

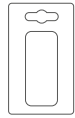
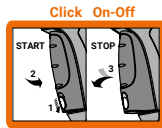

Ref. 15-705 12/48 EAN 5907558451481

NEO
TOOLS

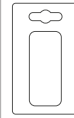
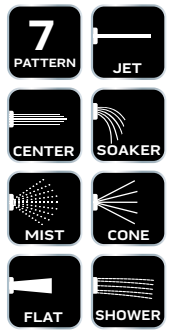

Ref. 15-706 12/48 EAN 5907558451498

NEO
TOOLS

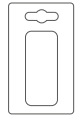

Ref. 15-707 12/48 EAN 5907558451504

NEO
TOOLS

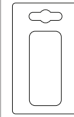

Ref. 15-708 6/24 EAN 5907558451511

VERTO

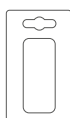
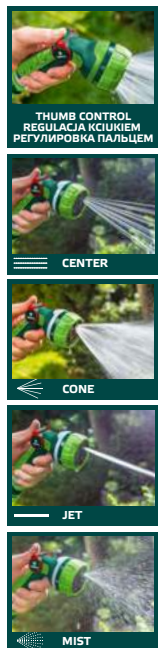

Ref. 15G710 12/48 EAN 5902062037824

VERTO



Ref. 15G707 12/24 EAN 5902062037794

Zraszacz pistoletowy

Water spray gun / Sprühpistole / Spritze / Опрыскатель пистолетный / Опрыскувач пістолетний / Űntöző pisztoly / Pistol de stropire / Postřikovací pistole / Pištoloňový postrekovač / Brizgalna pištola / Purkštukas - pistoletas / Laistīšanas pistole / Pīstol-pihustusotsak / Пистолет струйник / Raspršivač na pištoli / Pištoli prskalica / Εκτοξευτής νερού πιστόλι / Aspersor tipo pistola / Irrigatore a pistola / Pistola de aspersão / Arroiseur à pistolet / Slangkoppeling STOP

VERTO

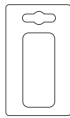

Ref. 15G704 12/48 EAN 5902062037763

VERTO

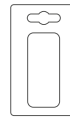

Ref. 15G702 12/48 EAN 5902062037749

VERTO

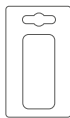

Ref. 15G709 12/36 EAN 5902062037817

VERTO

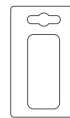

Ref. 15G706 12/48 EAN 5902062037787

VERTO

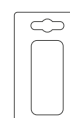
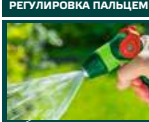
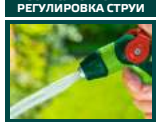

Ref. 15G703 12/48 EAN 5902062037756

VERTO

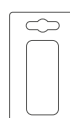

Ref. 15G708 0/14 EAN 5902062037800

Zraszacz pistoletowy

Water spray gun / Sprühpistole Spritze / Ороситель пистолетный / Опрыскивач пистолетный / Öntöző pisztoly / Pistol de stropire / Postřikovací pistole / Pištoľový postrekovač / Brizgalna pištola / Purkštukas - pistoletas / Laistīšanas pistole / Pūstol-pihustusotsak / Пустиллет струйник / Raspršivač na pištolj / Pištoľ prskalica / Εκτοξευτής νερού πιστόλι / Aspersor tipo pistola / Irrigatore a pistola / Pistola de aspersão / Arroser à pistolet / Slangkoppeling STOP

VERTO



WIDE STREAM
SZEROKI STRUMIEN
ШИРОКАЯ СТРУЯ

WATER PRESSURE REGULATION
REGULACJA CIŚNIENIA WODY
РЕГУЛИРОВКА НАПОРА ВОДЫ

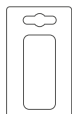

Ref.	☒	EAN
15G705	12/48	5902062037770

Zraszacz prosty

Straight water spray nozzle / Sprühregner / Ороситель прямой / Зрошувач прямий / Öntöző fej / Spritzer stropit / Postřikovač na hadici / Jednoduchý postrekovač / Ravna brizgalka / Tiesiu purkštukas / Laistīšanas uzgalis (taisnais) / Tavaline pihustusotsak / Прям струйник / Obični raspršivač / Obična prskalica / Εκτοξευτής νερού λάγη / Aspersor recto / Irrigatore dritto / Agulheta de aspersão / Arroser simple / Spuitpistool

NEO
TOOLS

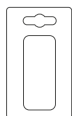

Ref.	☒	EAN
15-700	12/48	5907558451399

VERTO



STREAM CONTROL
REGULACJA STRUMIENIA
РЕГУЛИРОВКА СТРУИ

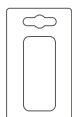

Ref.	☒	EAN
15G700	12/48	5902062037725

VERTO



STREAM CONTROL
REGULACJA STRUMIENIA
РЕГУЛИРОВКА СТРУИ



BIMATERIAL
DIELEKTRICZNY
ДВУХКОМПОНЕНТНЫЙ

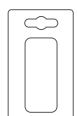

Ref.	☒	EAN
15G701	10/50	5902062037732

Zestaw ze zraszaczem prostym

Gardening set with straight nozzle / Набор с прямым оросителем / Set mit Sprühregner / Набор із прямим зрошувачем опрыскивачем / Öntöző fej zett / Set cu spritzer de stropit / Sada s postřikovačem na hadici / Súprava s jednoduchým postrekovačom / Komplet z ravno brizgalko / Laistymo komplektas su tiesiu purkštuku / Komplekts ar taisno laistīšanas uzgali / Tavalise otsakuga komplekt / Комплект с прав струйник / Set s običnim raspršivačem / Pribor sa običnom prskalicom / Σετ με εκτοξευτή νερού λάγη / Set con aspersor recto pistola / Kit irrigatore dritto / Kit com agulheta / Ensemble d'arroser simple / Set met spuitpistool

NEO
TOOLS



Ref.	∅ [mm]	☒	EAN
15-710	1/2	12/48	5907558451405
15-711	3/4	12/48	5907558451412

VERTO



Ref.	☒	EAN
15G711	6/48	5902062037831



STREAM CONTROL
REGULACJA STRUMIENIA
РЕГУЛИРОВКА СТРУИ



Zestaw ze zraszaczem pistoletowym

Gardening set with water spray gun / Набор пистолетным опрыскивателем / Set mit Sprühpistole / Набор із пистолетним опрыскувачем / Öntöző pisztoly szett / Set cu pistol de stropire / Sada s postřikovací pistolí / Súprava s pištoľovým postrekovačom / Komplet z brízgalno pištoľo / Laistymo komplektas su purkštuku pistoletu / Komplekts ar taisno laistīšanas pistolī / Tavalise pūstoltsakuga komplekt / Комплект с пистолетом струйник / Set s raspršivačem na pištoľ / Pribor sa pištoľj prskalicom / Σετ με εκτοξευτή νερού πιστόλι / Set con aspersor tipo pistola / Kit irrigatore a pistola / Kit com pistola de aspersão / Ensemble d'arroseur à pistolet / Tuingereedschapsriem

VERTO

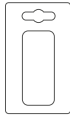

Ref. EAN
15G713 10/50 5902062037848

VERTO

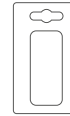

Ref. EAN
15G712 6/48 5902062038364

Zraszacz oscylacyjny

Oscillating sprinkler / Rasensprenger / Дождеватель маятниковый / Зрошувач осциляційний / Billenő öntöző / Aspersor oscilant / Oscilační postřikovač / Oscilačný postrekovač / Nihajni zalivalnik / Švytuoklinis purkštukas / Dārza laistītājs / Pöörtev pihustusotsak / Осциллятор разпрыскач / Oscilirajući raspršivač / Oscilatorna prskalica / Ποτιστικό βεντάλια απρικλερ / Aspersor oscilante / Irrigatore oscillante / Aspersor oscilante / Arroseur oscillant / Slanghaspel gemonteerd

NEO TOOLS

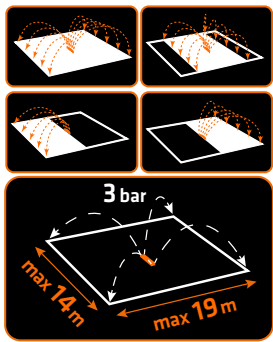

Ref. EAN
15-771 0/6 5907558451375

NEO TOOLS

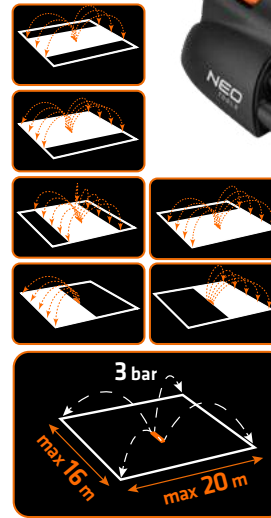

Ref. EAN
15-772 0/6 5907558451382

VERTO

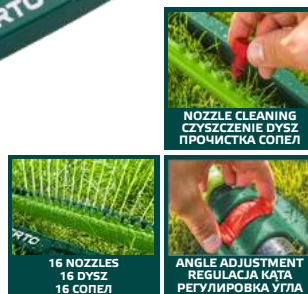

Ref. EAN
15G770 10/20 5902062038012

VERTO



Ref. EAN
15G771 0/8 5902062038029

Zraszacz oscylacyjny

Oscillating sprinkler / Rasensprenger / Дождеватель маятниковый / Зрошувач осциляційний / Billenő öntöző / Aspersor oscilant / Oscilační postřikovač / Oscilačný postrekovač / Nihajni zalivalnik / Šyruoklinis purkštukas / Dārza laistītājs / Põrlev pihustusotsak / Осциллятор разбрызгивач / Oscilirajući raspršivač / Oscilatorna prskalica / Ποτιστικό βεντάλια σπρίνκλερ / Aspersor oscilante / Irrigatore oscillante / Aspersor oscilante / Arroseur oscillant / Slanghaspel gemonteerd

VERTO



NOZZLE CLEANING
CZYSZCZENIE DYSZ
ПРОЧИСТКА СОПЕЛ



WIDTH ADJUSTMENT
REGULACJA SZEROKOŚCI
РЕГУЛИРОВКА ШИРИНЫ

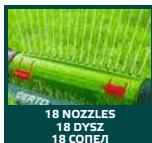

18 NOZZLES
18 DYSZ
18 СОПЕЛ

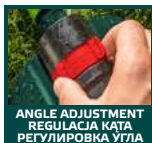

ANGLE ADJUSTMENT
REGULACJA KĄTA
РЕГУЛИРОВКА УГЛА

Ref. 15G772 4/8 EAN 5902062038036

VERTO



ANGLE ADJUSTMENT
REGULACJA KĄTA
РЕГУЛИРОВКА УГЛА



WIDTH ADJUSTMENT
REGULACJA SZEROKOŚCI
РЕГУЛИРОВКА ШИРИНЫ



STREAM CONTROL
REGULACJA STRUMIENIA
РЕГУЛИРОВКА СТРУИ

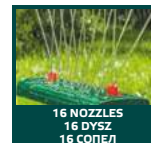

16 NOZZLES
16 DYSZ
16 СОПЕЛ

Ref. 15G773 6/12 EAN 5902062038043

Zraszacz ogrodowy

Garden sprinkler / Gartensprenger / Ороситель садовый / Опрыскивач садовий / Kerti locsoló / Sprinkler de grădină / Zahradní postřikovač / Záhradný postrekovač / Vrtni zalivalnik / Sodo purkštukas / Dārza laistītājs / Аіаріһусті / Градинска пръскачка / Orošivač za vrt / Prskalica za baštu / Εκτοξευτήρας κήπου / Aspersor de jardín / Irrigatore da giardino

NEO
TOOLS



Ref. 15-780 4/24 EAN 5907558451368

VERTO



COVERAGE CONTROL

Ref. 15G788 0/6 EAN 5902062054395

VERTO



8-PATTERN
8-FUNKCJI
8-ФУНКЦИИ

Ref. 15G780 0/6 EAN 5902062054364

VERTO



9-PATTERN
9-FUNKCJI
9-ФУНКЦИИ

Ref. 15G781 0/6 EAN 5902062054371



0-360°



Ref. 15G785 12/48 EAN 5902062054388

Złączka

Connector / Kupplung / Соединитель / З'єднувальний елемент / Csatlakozó / Manşon / Spojka / Spájací článok / Spojka / Jungtis / Savienotājs / Ühendused / Муфта / Klema / Spojka / Συνδεαός / Conector / Raccordo / União / Raccord / Sproeier

VERTO



Ref.	Ø ["]	N	☒	EAN
15G720	1/2	x1	12/96	5902062037855
15G720-30	1/2	x30	0/1	5902062050601

VERTO



Ref.	Ø ["]	N	☒	EAN
15G721	1/2	x1	12/96	5902062037862
15G721-30	1/2	x30	0/1	5902062050618

VERTO



Ref.	Ø ["]	N	☒	EAN
15G732	3/4	x1	20/240	5902062037916
15G732-30	3/4	x30	0/4	5902062050663

VERTO



Ref.	N	☒	EAN
15G733	x1	20/240	5902062037923
15G733-30	x30	0/4	5902062050670

VERTO



Ref.	Ø ["]	N	☒	EAN
15G722	3/4	x1	12/96	5902062037879
15G722-30	3/4	x30	0/1	5902062050625

VERTO



Ref.	Ø ["]	N	☒	EAN
15G723	3/4	x1	12/96	5902062037886
15G723-30	3/4	x30	0/1	5902062050632

VERTO



Ref.	Ø ["]	N	☒	EAN
15G730	1/2 - 5/8	x1	20/240	5902062037893
15G730-30	1/2 - 5/8	x30	0/4	5902062050649

VERTO



Ref.	Ø ["]	N	☒	EAN
15G731	1/2 - 5/8	x1	20/240	5902062037909
15G731-30	1/2 - 5/8	x30	0/4	5902062050656

Reparator do węży

Hose repair connector / Schlauchverbinder / Универсальная ремонтная муфта / Reparatör do szlangu / Tomlötaldó javító / Cuple imbinare furture / Hadicová oprávka / Hadicová spojka / Reparatör za cev / Jungtis žarnai / Remontuzmana dārza šļūtenei / Vooliku parandamise ühendus / Муфта-с'єдинител за маркуч / Reparatör za crijevo / Reparatör za crevo / Συνδεαός για ένωσή δύο λάστιχων / Reparatör de manguera / Raccordo riparatore / Reparatör de mangueira / Réparateur de tuyau / Knelkoppeling

VERTO



Ref.	Ø ["]	N	☒	EAN
15G742	1/2	x1	12/96	5902062037954
15G742-30	1/2	x30	0/1	5902062050694
15G743	3/4	x1	12/96	5902062037961
15G743-30	3/4	x30	0/1	5902062050700

VERTO



Ref.	Ø ["]	N	☒	EAN
15G746	1/2	x1	20/240	5902062054418
15G747	3/4	x30	20/240	5902062054425

Przylacze do kranu

Hose tap connector / Hahnstück / Адаптер на кран / Адаптер до крану / Csapcsatlakozó / Adaptor robinet / Pripojka na kohoutek / Pripojka na vodovod / Prikluček za pipo / Цяуро jungtis / Krāna īscaurules / Kraaniühendus / Адаптор за кран / Priključak za slavinu / Priključak za slavinu / Πακόρ για βρύση / Conector para grifo / Adattatore per rubinetto / União de torneira / Ajutage de robinet / Kraanverbinstuk

VERTO



Ref.	Ø ["]	N	☒	EAN
15G740	1/2 - 3/4	x1	12/96	5902062037930
15G740-30	1/2 - 3/4	x30	0/6	5902062050687

Rozdzielacz typu Y

3 way hose connector / Y-Schlauchverteiler / Тройник / Сепаратор-трійник / 3-utas csatlakozó / Conector extensie triplu / Y-kus / Rozdeľovač typ Y / Razdelilnik tipa Y / Trišakis greito jungimo laistymo žarnos sujungti / Y tipo / Y tipa sadalītājs / Y-tüüpi jaotur / Тройник за бърза връзка / Y razvodnik / Razdelnik tipa Y / Συνδεσμος τριών ταχισυνδέσμων / Derivación tipo Y triple / Raccordo a Y / União em Y / Répartiteur de type Y / 3-weg stuk Y

VERTO

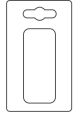

Ref.	N	☒	EAN
15G744	x1	12/96	5902062037978
15G744-30	x30	0/1	5902062050717

Złącze typu I

2 way connector / Schlauchverbinder gerade / Двоійник / З'єднувач тупий I / Tömöl összekötő csatlakozó / Cupla furturn / Hadicová spojka / Spojka typ I / Dvojni priključek za cev / Jungtis laistymo žarnos sujungti, I tipo / I tipa savienotāji / I-tüüpi ühendus / Съединител за бърза връзка / Spoj tipa I / Priključak tipa I / Συνδεσμος δύο ταχισυνδέσμων / Conector tipo I / Raccordo dritto / União em I / Connecteur raccord de type I / 1-weg stuk I

VERTO

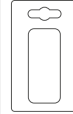

Ref.	N	☒	EAN
15G745	x1	12/96	5902062037985
15G745-30	x30	0/1	5902062050724

VERTO

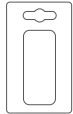

Ref.	☒	EAN
15G760	12/72	5902062054432

VERTO

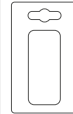

Ref.	☒	EAN
15G761	10/40	5902062054449

Wyłącznik czasowy

Timer switch / Wasserschaltuhr / Таймер для полива / Вимикач таймерний / Óntöző időzítő kapcsoló / Programator irigații / Časový spínač / Časovník / Laistymo laikmatis / Laika slēdzis / Taimeriga lüliti / Таймер за изключване / Vremenski prekidač / Таймер / Χρονοδιακόπτης ποτίσματος / Temporizador / Interruttore temporizzato / Programador de rega / Minuterie d'arrosage / Tijdschakelaar

VERTO

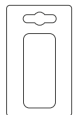

Ref.	☒	EAN
15G750	0/12	5902062037992



RIGHT / LEFT
PRAWO / LEWO
ПРАВА / ЛЕВА



1" > 3/4"

Opryskiwacz akumulatorowy

Battery sprayer / Batteriesprüngerät / Акумуляторний распылитель / Акумуляторний розливаюч / Az akkumulátor permetezője / Pulverizator pentru baterii / Baterie postřikovač / Batériový postrekovač / Razpršilnik akumulatorja / Bateriju purkštuvus / Akumulatora smidzinātājs / Aku pihusti / Акумуляторна пръскачка / Prskalica za baterije / Прскалица за батерије / Ψεκαστήρας μπαταρίας / Pulverizador de batería / Spruzzatore della batteria / Pulverizador para batería / Pulvérisateur à batterie / Accu-sproeier

NEO
TOOLS



VERTO

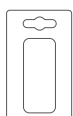

Ref.	☒	EAN
15G751	0/4	5902062038005



13 MEMORY PRESET
13 USTAVENÁ PAMĚŤ
13 ПРЕДУСТАНОВОК ПАМ'ЯТІ

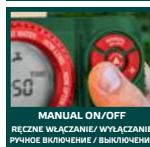

MANUAL ON/OFF
RÚČNE VYPNUTIE / VYPNUTIE
РУЧНОЕ ВКЛЮЧЕНИЕ / ВЫКЛЮЧЕНИЕ

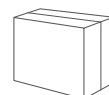

Ref.	☒	EAN
15-715	0/18	5907558443295

Opryskiwacz

Spraying machine / Spritzgerät / Опрыскиватель / Опрыскупач / Permetező / Aparat de stropit / Postřikovač / Postrekovalč / Škropilnik / Purkštuvav / Smidzinātājs / Piserdi / Пульверизатор / Prskalica / Prskalica / Ψεκαστήρας / Aspersor / Atomizzatore / Máquina regadora / Pulvérisateur / Spuittoestel

VERTO



Ref.	Info	☒	EAN
156501	1l	0/20	5902062037237
156502	1,5l	0/15	5902062037244
156503	2l	0/15	5902062037251

VERTO

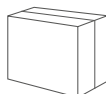

Ref.	Info	☒	EAN
156504	3l	1/6	5902062037268
156505	5l	1/6	5902062037275
156506	7l	1/6	5902062037282



SAFETY VALVE
ZAWÓR BEZPIECZEŃSTWA
КЛАПАН БЕЗОПАСНОСТІ



FLOW: MAX 55 mL/min
WYDAJNOŚĆ: MAX 55 mL/min
ПРОИЗВОДИТЕЛЬНОСТЬ: MAX 55 mL/min



PRESSURE: MAX 2.5 BAR
CIŚNIENIE: MAX 2.5 BAR
НАПОР: MAX 2.5 BAR

VERTO



FLOW: MAX 90 mL/min
WYDAJNOŚĆ: MAX 90 mL/min
ПРОИЗВОДИТЕЛЬНОСТЬ: MAX 90 mL/min



PRESSURE: MAX 3.5 BAR
CIŚNIENIE: MAX 3.5 BAR
НАПОР: MAX 3.5 BAR

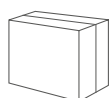

Ref.	Info	☒	EAN
156507	15l	0/1	5902062037299
156508	20l	0/1	5902062037305

Stojak do węża

Hose reel stand / Schlauchtrommel mit Gestell / Катуха для шланга на подставке / Стійка до шлангу / Tomládob / Tambur pentru furturen / Stojan na hadici / Stojan na hadici / Stojalo za cev / Stovas žarnai / Dārza šļūtenes statīvs / Voolikhoidik / Макара за градински марнуч / Stalak za crijevo / Stalak za crevo / Καρούλι ποτισματος επιδαπέδιο / Soporte para manguera / Avvolgitubo / Enrolador de mangueira / Support de dévidoir-enrouleur / Slanghaspel gemonteerd

NEO TOOLS



METAL

100m
1/2"

30m
3/4"

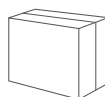

Ref.	☒	EAN
15-790	0/4	5907558451320

NEO TOOLS



60m
1/2"

20m
3/4"

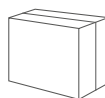

Ref.	☒	EAN
15-791	0/5	5907558451344

VERTO

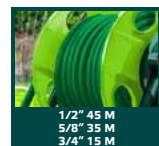

1/2" 45 M
5/8" 35 M
3/4" 15 M



PORTABLE
PRZENOŚNY
ПЕРЕНОСНОЙ

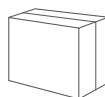

Ref.	☒	EAN
156790	0/6	5902062038104

Wózek do węża

Hose reel trolley / Schlauchwagen / Κατινίνα для шланга на колесах / Візок для шлангу / Tömlőkocsi / Cărucior suport pentru furtun / Vozik na hadici / Vozik na hadicu / Voziček za cev / Žarný vežimelis / Dārza šļūtenes ratiņi / Voelikukäru / Колычка за градински маркуч / Kolica za crijevo / Kolica za crevo / Καρούλι ποτίζματος τροχήλατο / Carretilla para manguera / Carrello avvolgitubo / Carrinho enrolador de mangueira / Chariot de tuyau d'arrosage / Haspelkar

NEO
TOOLS



METAL

60m
1/2"

20m
3/4"

Ref. 15-792 Info 0/2 EAN 5907558451337

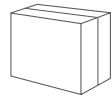

NEO
TOOLS



60m
1/2"

20m
3/4"

Ref. 15-793 Info 0/5 EAN 5907558451351

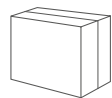

VERTO

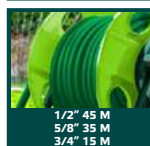

Ref. 15G791 Info 0/6 EAN 5902062038111

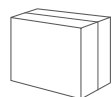

Wieszak na węża

Hose hanger / Wandschlauchhalter / Вешалка для поливочного шланга / Підвішувач для шлангу / Tömlőtartó / Suport furtun / Závěs na hadici / Vešák na hadicu / Obešalnik za cev / Žarnos rakaba / Dārza šļūtenes turētājs / Vooliku riputuskonks / Стенная стойка за градински маркуч / Vješalica za crijevo / Vešalica za crevo / Βάση-Στέλα τοίχου για λάστιχο ποτίζματος / Colgador de manguera / Portatubo / Suporte de mangueira / Support de tuyau d'arrosage / Slangophang



Ref. 15G798 Info 20m x 1/2" Info 0/50 EAN 5902062038128

Prowadnica do węża rolkowa

Roller hose guide / Rollenschlauchführung / Роликовая направляющая для шланга / Направляюча роликового шланга / Görgős tömlővezető / Ghidaj furtun cu role / Vedení hadice válce / Vedenie hadice vačeka / Vodilo valjaste cevi / Ritinių žarnų kreiptuvas / Rullīšu šļūtenes vadotne / Rullivooliku juht / Водач за ролкови маркучи / Vodič valjkastog crijeva / Водич валяног црева / Οδηγός εύκαμπτου σωλήνα / Guia de mangueira de rodillo / Guida tubo a rullo / Guia da mangueira de rolo / Guide de tuyau à rouleau / RolSlanggeleider



Ref. 15G851 Info 0/20 EAN 5902062507921

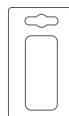

Prowadnica do węża zamknięta

Hose guide closed / Schlauchführung geschlossen / Направляюча шланга закрьта / Направляюча шланга закрпма / A tömlővezető csukva van / Ghidajul furtunului închis / Vedení hadice zavřené / Vedenie hadice zatvorené / Vodilo za cev je zaprto / Žarnos kreiptuvas uždarytas / Šļūtenes vadotne ir aizvērtā / Voelikujuhik on suletud / Водачът на маркуча е затворен / Vodič crijeva zatvoren / Водич за црево затворен / Ο οδηγός σωλήνα έκλεισε / Guia de mangueira cerrada / Guida del tubo chiusa / Guia de mangueira fechada / Guide de tuyau fermé / Slanggeleider gesloten



Ref. 15G852 Info 6/24 EAN 5902062507938

Wąż ogrodowy

Garden hose / Gartenschlauch / Шланг садовий / Шланг садовий / Kerti tömlő / Furtun de gradina / Zahradní hadice / Záhradná hadica / Vrtna cev / Sodo žarna / Dārza šļūtene / Aivavolīk / Градински маркуч / Crijevo za vrt / Bašensko crevo / Λάστιχο κήπου / Manguera de jardín / Tubo da giardino / Tuinslang

NEO
TOOLS

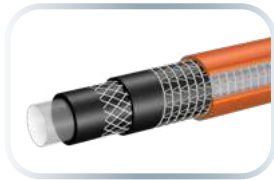

Ref.	Ø ["]	L [m]	☒	EAN
15-840	1/2	20	0/1	5907558444483
15-841	1/2	30	0/1	5907558444490
15-842	1/2	50	0/1	5907558444506
15-843	3/4	20	0/1	5907558444513
15-844	3/4	30	0/1	5907558444520
15-845	3/4	50	0/1	5907558444537

NEO
TOOLS

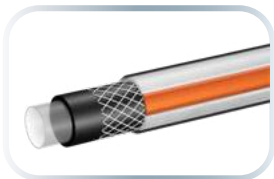

Ref.	Ø ["]	L [m]	☒	EAN
15-820	1/2	20	0/1	5907558444421
15-821	1/2	30	0/1	5907558444438
15-822	1/2	50	0/1	5907558444445
15-823	3/4	20	0/1	5907558444452
15-824	3/4	30	0/1	5907558444469
15-825	3/4	50	0/1	5907558444476

NEO
TOOLS

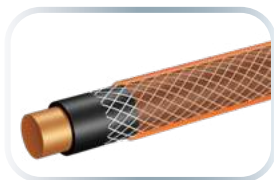

Ref.	Ø ["]	L [m]	☒	EAN
15-800	1/2	20	0/1	5907558444360
15-801	1/2	30	0/1	5907558444377
15-802	1/2	50	0/1	5907558444384
15-803	3/4	20	0/1	5907558444391
15-804	3/4	30	0/1	5907558444407
15-805	3/4	50	0/1	5907558444414

VERTO

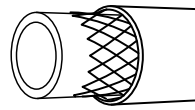

Ref.	Ø ["]	L [m]	☒	EAN
15G820	1/2	20	0/1	5902062039309
15G821	1/2	30	0/1	5902062039316
15G822	1/2	50	0/1	5902062039323
15G823	3/4	20	0/1	5902062039330
15G824	3/4	30	0/1	5902062039347
15G825	3/4	50	0/1	5902062039354

VERTO

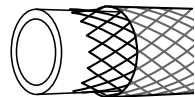

Ref.	Ø ["]	L [m]	☒	EAN
15G800	1/2	20	0/1	5902062039309
15G801	1/2	30	0/1	5902062039316
15G802	1/2	50	0/1	5902062039323
15G803	3/4	20	0/1	5902062039330
15G804	3/4	30	0/1	5902062039347
15G805	3/4	50	0/1	5902062039354

Wąż ogrodowy rozciągliwy

Flexible garden hose / Garten-Streckschlauch / Шланг садовий розтягуваний / Шланг садовий, що розтягується / Rugalmas kerti tömlő / Furtun de gradină extensibil / Elastická zahradní hadice / Záhradná pružná hadica / Raztegljiva vrtna cev / Sodo žarna, išsitempianti / Iztiepjamā dārza šļūtene (izplešas laistīšanas laikā) / Pikendatav aivavolīk / Разтягательн градински маркуч / Elastično vrtno crijevo / Elastično bašensko crevo / Λάστιχο ποτίσματος ελαστικό / Manguera de jardín flexible / Tubo elastico da giardino

VERTO

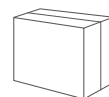
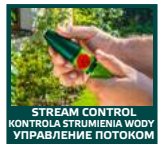

Ref.	L [m]	☒	EAN
15G890	7,5 - 22,5	0/8	5902062054401

Wąż z automatycznym zwijaczem

Hose with automatic retractor / Schlauch mit automatischem Retraktor / Шланг с автоматическим втягивающим устройством / Шланг з автоматичним втягувачем / Tömlő automatikus visszahúzóval / Furtun cu retractor automat / Hadice s automatickým navijáčem / Hadica s automatickým navijačom / Cev z avtomatskim navijalom / Žarna su automatinu i'traukikliu / Šlütene ar automātisko spriegotāju / Automaatse tömbluriga voolik / Маркуч с автоматично прубурацо устройство / Crijevo s avtomatskim uvlačiteljem / Црево са аутоматским увлакачем / Σωλήνας με αυτόματο συσπειρωτήρα / Manguera con retractor automático / Tubo con riavvolgitore automatico / Mangueira com retractor automático / Tuyau avec enrouleur automatique / Slang met automatisch oprolmechanisme

NEO
TOOLS



20m
+2m

auto
roll-up

1/2"

180°

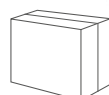

Ref.	Info	EAN
15-891	0/1	5907558451313

VERTO



HOSE STOP
AUTOMATYCZNA BLOKADA
OSTANÓWKA SZLANTA



NOZZLE AND CONNECTORS INCLUDED
Z DYŹYŃ I ZŁĄCZAMI
СОПЛО И РАЗЪЕМЫ В КОМПЛЕКТЕ

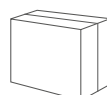

Ref.	Info	EAN
156891	1/2", 20+2m	5902062507945

Sektor ogrodowy

Garden pruner / Gartenschere / Секатор садовый / Секатор садовий / Metszőolló / Foarfeca de gradina / Zahradnické nůžky / Nožnice záhradnicke / Vrtne škarje / Sodo sektorius / Dārza grieznes / Oksakäärid / Ножуца лозарска / Škare za obrezivanje / Makaze za orezivanje / Ψαλίδι κλαδέματος / Tijeras de jardín / Cesoia da giardino / Podadeira para jardim / Sécateur de jardin / Tuintakenschaar

VERTO



BY-PASS BLADE
OSTRZA NOŻYCOWE
ПЛОСКОСТНЫЕ ЛЕЗВИЯ
PTFE

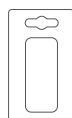

Ref.	Info	EAN
156200	ø max 10 mm	5902062036995

VERTO



BLADE LOCK
BLOKADA OSTRZA
БЛОКИРОВКА ЛЕЗВИЯ
BY-PASS BLADE
OSTRZA NOŻYCOWE
ПЛОСКОСТНЫЕ ЛЕЗВИЯ

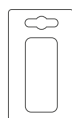

Ref.	Info	EAN
156202	ø max 12 mm	5902062037015

VERTO

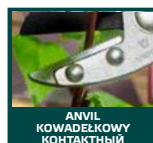

ANVIL
KOWADEŁKOWY
КОНТАКТНЫЙ
PTFE

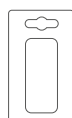

Ref.	Info	EAN
156201	ø max 10 mm	5902062037008

VERTO



BLADE LOCK
BLOKADA OSTRZA
БЛОКИРОВКА ЛЕЗВИЯ
ANVIL
KOWADEŁKOWY
КОНТАКТНЫЙ

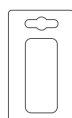

Ref.	Info	EAN
156203	ø max 12 mm	5902062037022

Sektor ogrodowy

Garden pruner / Gartenschere / Секатор садовый / Секатор садовый / Metszőolló / Foarfeca de gradina / Zahradnické nůžky / Nožnice záhradnícke / Vrtne škarje / Sodo sektorius / Dārza grieznes / Oksakäärid / Ножница лозарска / Škare za obrezivanje / Makaze za orezivanje / Φαλίδι κλαδέματος / Tijeras de jardín / Cesoia da giardino / Podadeira para jardim / Sécateur de jardin / Tuintakkschaar

VERTO



EASY CUTTING
LATWE CIĘCIE
УДОБНАЯ РЕЗКА



ANVIL
KOWADEŁKOWY
KONTAKTNY

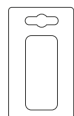

Ref.	Info	☒	EAN
15G205	ø max 20 mm	12/72	5902062037046

VERTO



15°
ERGONOMIC SHAPE
ERGONOMICZNY KSZTAŁT
ЭРГОНОМИЧНАЯ ФОРМА

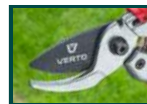

BY-PASS BLADE
OSTRZA NOŻYSCOWE
ПЛОСКОСТНЫЕ ЛЕЗВИЯ

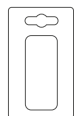

Ref.	Info	☒	EAN
15G206	ø max 18 mm	12/72	5902062037053

VERTO



BLADE LOCK
BLOKADA OSTRZA
БЛОКИРОВКА ЛЕЗВИЯ



BY-PASS BLADE
OSTRZA NOŻYSCOWE
ПЛОСКОСТНЫЕ ЛЕЗВИЯ

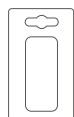

Ref.	Info	☒	EAN
15G204	ø max 15 mm	10/60	5902062037039

VERTO



15°
ERGONOMIC SHAPE
ERGONOMICZNY KSZTAŁT
ЭРГОНОМИЧНАЯ ФОРМА



ANVIL
KOWADEŁKOWY
KONTAKTNY

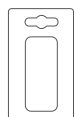

Ref.	Info	☒	EAN
15G207	ø max 18 mm	12/72	5902062037060

Sektor do gałęzi

Lopping shears / Astschere / Сучкорез / Сучкоріз / Ágvágó olló / Foarfeca de gradina / Zahradnické nůžky na větve / Nožnice na konáre / Škarje za obrezovanje vej / Sektorius šakoms / Grieznes zariem / Kärpimiskäärid / Ножница за клони / Škare za grane / Makaze za grane / Φαλίδι κλαδέματος / Tijeras de podar / Cesoia per rami / Podadeira de ramos / Sécateur à branches / Takkschaar

VERTO



BIMATERIAL
DWMATERIALOWY
ДВУХКОМПОНЕНТНЫЙ



FIBREGLASS
WŁOKNO SZKLANE
СТЕКЛО ВОЛОКНО

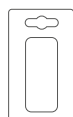

Ref.	Info	☒	EAN
15G255	ø max 30 mm	0/12	5902062037138

VERTO



TELESCOPIC 700 - 1000 MM
TELESKOPOWY 700 - 1000 MM
ТЕЛЕСКОПИЧЕСКИЙ 700 - 1000 MM



POWER +20%
MOC +20%
МОЩНОСТЬ +20%

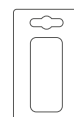

Ref.	Info	☒	EAN
15G253	ø max 35 mm	0/6	5902062037114

VERTO



POWER +30%
MOC +30%
МОЩНОСТЬ +30%



BY-PASS BLADE
OSTRZA NOŻYSCOWE
ПЛОСКОСТНЫЕ ЛЕЗВИЯ

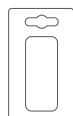

Ref.	Info	☒	EAN
15G258	ø max 45 mm	0/12	5902062037169

VERTO



POWER +30%
MOC +30%
МОЩНОСТЬ +30%



ANVIL
KOWADEŁKOWY
KONTAKTNY

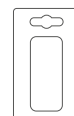

Ref.	Info	☒	EAN
15G259	ø max 45 mm	0/12	5902062037176

Sektor do gałęzi

Lopping shears / Astschere / Сучкорез / Сучкоріз / Άρνάγό ολό / Foarfeca de gradina / Zahradnické nůžky na větve / Nožnice na konáre / Škarje za obrezovanje vej / Sekatorius šakoms / Grieznes zariem / Kärpimiskäärid / Ножница за клоно / Škare za grane / Makaze za grane / Φαλίδι κλαδέματος / Tijeras de podar / Cesoia per rami / Poadeira de ramos / Sécateur à branches / Takkenschaar

VERTO



Ref.	Info	📦	EAN
156256	ø max 42 mm	0/12	5902062037145

VERTO



Ref.	Info	📦	EAN
156257	ø max 42 mm	0/12	5902062037152

VERTO

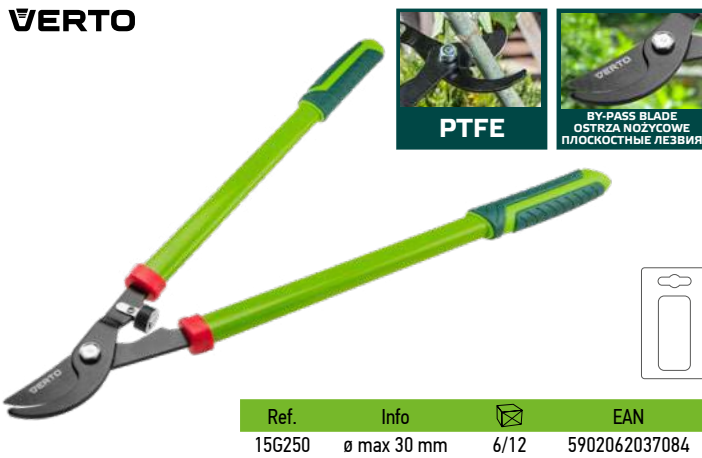

Ref.	Info	📦	EAN
156250	ø max 30 mm	6/12	5902062037084

VERTO

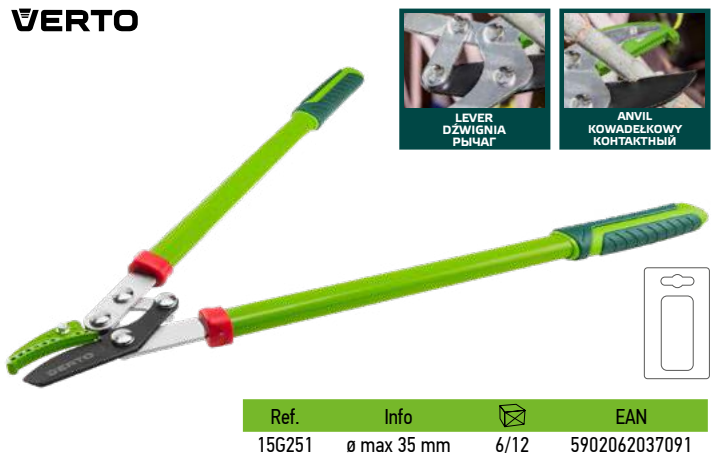

Ref.	Info	📦	EAN
156251	ø max 35 mm	6/12	5902062037091

VERTO

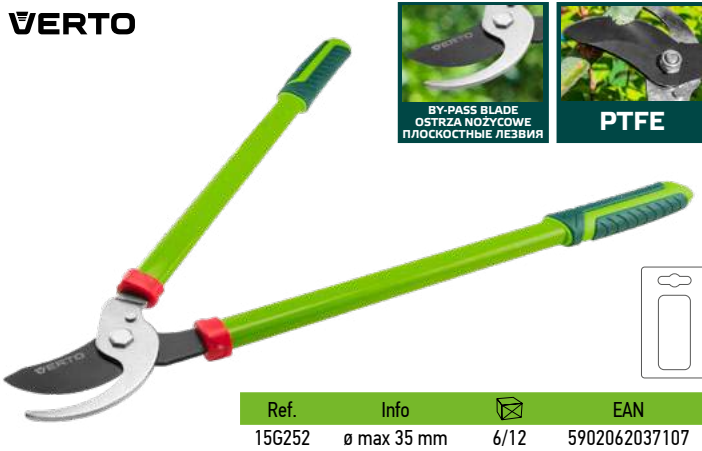

Ref.	Info	📦	EAN
156252	ø max 35 mm	6/12	5902062037107

VERTO



Ref.	Info	📦	EAN
156254	ø max 30 mm	0/12	5902062037121

Sektor z piłą

Saw pruner / Baumschere mit säge / Секатор с пилой / Секатор з пилкою / Άρνάγό fűrészszel / Foarfecă cu piilă / Zahradní nůžky s pilkou / Nožnice s pilou / Škarje z žago / Sekatorius su pjūkleliu / Dārza grieznes ar zāģi / Lõikur koos saega / Градинарски ножници с трион / Vrtnе škare s pilom / Baštenske makaze sa pilom / Φαλίδι με πριόνι / Tijeras podaderas con sierra / Sveltatoio a pertica con segaccio tagliarami / Podadeira de fita / Sécateur à chenilles / Snoeischaar

VERTO

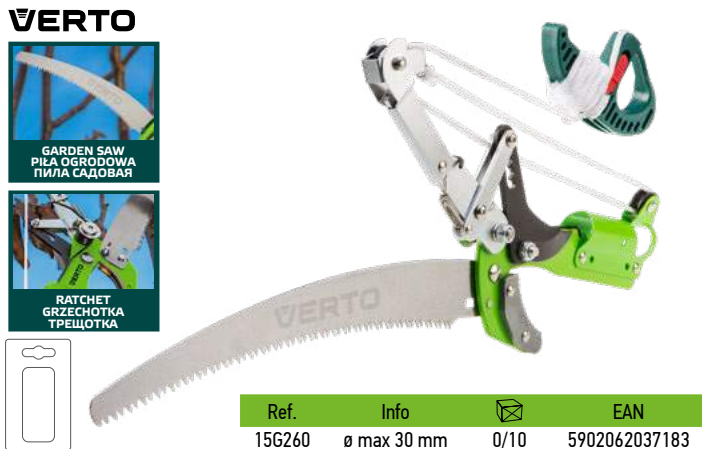

Ref.	Info	📦	EAN
156260	ø max 30 mm	0/10	5902062037183

Trzonek teleskopowy

Telescopic handle / Teleskopstiel / Штанга телескопическая / Штанга телескопічна / Teleszkópos nyél / Manivelă telescopică / Teleskopická násada / Rukoväť teleskopická / Teleskopski ročaj / Teleskopinė rankena / Teleskopisks rokūris / Teleskoopkæpeide / Τηλεσκοπική άρξηση / Teleskopska drška / Teleskopska drska / Τηλεσκοπικό κονταροπριόνιο / Mango telescópico / Zoccolo telescopico / Cabo telescópico / Manche telescopique / Teleskopisch handvat

VERTO

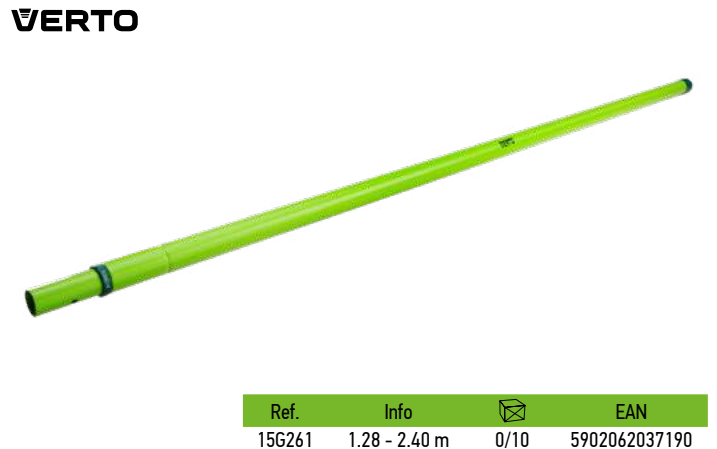

Ref.	Info	📦	EAN
156261	1.28 - 2.40 m	0/10	5902062037190

Nożyce do żywopłotu

Hedge shears / Heckenschere / Ножницы для живой изгороди / Ножици до животнопты / Sövényvágó olló / Foarfece grădină / Nůžky na živý plot / Nožnice na živý plot / Škarje za živo mejo / Žirkles gyvatvorei / Grieznes krūmiem / Hekikäärid / Ножица за храсту / Škare za živu ogradu / Makaze za živu ogradu / Ψαλίδι για γρασίδι / Forbici per siepe / Tesoura p. vedação / Cisaille à haie /



STRAIGHT BLADES
OSTRZA PROSTE
ПРЯМЫЕ ЛЕЗВИЯ



ERGONOMIC SHAPE
ERGONOMICZNY KSZTAŁT
ЭРГОНОМИЧНАЯ ФОРМА

VERTO

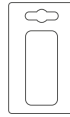

Ref.	Info	☒	EAN
15G310	185 mm	6/12	5902062037404



WAVY BLADES
OSTRZA FALOWANE
ОЛНИСТЫЕ ЛЕЗВИЯ



TELESCOPIC 670 - 880 MM
TELESKOPOWY 670 - 880 MM
ТЕЛЕСКОПИЧЕСКИЙ 670 - 880 MM

VERTO

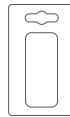

Ref.	Info	☒	EAN
15G312	200 mm	6/12	5902062037428



WAVY BLADES
OSTRZA FALOWANE
ОЛНИСТЫЕ ЛЕЗВИЯ



ERGONOMIC SHAPE
ERGONOMICZNY KSZTAŁT
ЭРГОНОМИЧНАЯ ФОРМА

VERTO

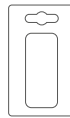

Ref.	Info	☒	EAN
15G311	200 mm	6/12	5902062037411



POWER +30%
МОЩЬ +30%
МОЩНОСТЬ +30%



BIMATERIAL
ДВУХМАТЕРИАЛЬНУЮ
ДВУХКОМПОНЕНТНУЮ

VERTO

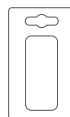
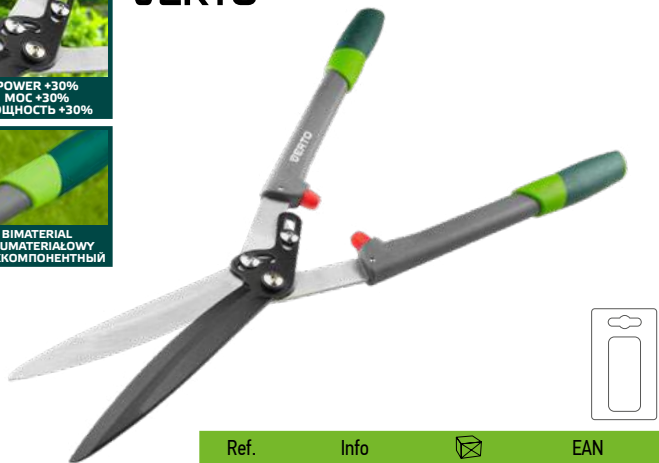

Ref.	Info	☒	EAN
15G313	210 mm	0/12	5902062037435

Nożyce do trawy

Grass shears / Grasschere / Ножницы газонные / Ножици газонні / Fűszegélyvágó olló / Foarfece gazon / Nůžky na trávník / Nožnice na trávu / Škarje za travo / Žirkles žolei / Grieznes zālajam / Rohukäärid / Ножица за трева / Škare za travu / Makaze za travu / Ψαλίδι για γρασίδι / Forbici per erbe / Tesoura para relva / Cisaille à gazon / Grasscharen

VERTO



ERGONOMIC SHAPE
ERGONOMICZNY KSZTAŁT
ЭРГОНОМИЧНАЯ ФОРМА

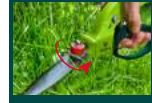

360°

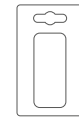

Ref.	Info	☒	EAN
15G300	360°	10/60	5902062037374

VERTO



ERGONOMIC SHAPE
ERGONOMICZNY KSZTAŁT
ЭРГОНОМИЧНАЯ ФОРМА

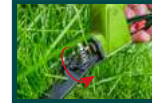

90°

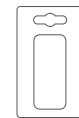

Ref.	Info	☒	EAN
15G301	90°	12/60	5902062037381

VERTO



ERGONOMIC SHAPE
ERGONOMICZNY KSZTAŁT
ЭРГОНОМИЧНАЯ ФОРМА



360°

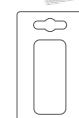

Ref.	Info	☒	EAN
15G302	360°	12/72	5902062037398

Piła ogrodowa

Saw / Gartensäge / Пила садовая / Пилка садова / Ágvágófűrés / Ferestrău / Zahradní pilka / Pilka záhradkárska / Žaga / Pjūklas / Žāģis / Saag / Трион / Pila / Testera / Αλυσοπίο / Sega per frutteto / Serra agrícola / Scie de jardin / Boomzaag

VERTO



EASY FOLDING
ŁATWE SKŁADANIE
ПРОСТОЕ СКЛАДЫВАНИЕ



HAND PROTECTION
OCHRONA DŁONI
ЗАЩИТА РУК



BLADE LOCK BUTTON
PRZYCIŚK BLOKADY OSTRZA
КНОПКА БЛОКИРОВКИ ЛЕЗВИЯ



7 TPI

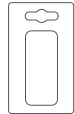

Ref.	L [mm]	☒	EAN
15G100	180	0/20	5902062038210

VERTO



DURABLE COVER
WYTRZYMAŁA OSŁONA
ПРОЧНАЯ ЗАЩИТА



EASY UNFASTENING
ŁATWE ROZPINANIE
УДОБНОЕ РАССТЕГИВАНИЕ



CARRY ON BELT
DO NOSZENIA NA PASKU
ДЛЯ НОШЕНИЯ НА РЕМНЕ



7 TPI

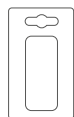

Ref.	L [mm]	☒	EAN
15G101	350	0/20	5902062038227

VERTO

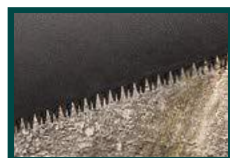

HARDENED
HARTOWANE
ЗАКАЛЕННЫЕ

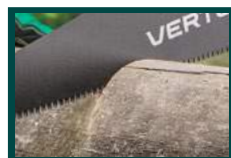

FOR WOOD
DO DREWNA
ПО ДЕРЕВУ



7 TPI

Ref.	L [mm]	☒	EAN
15G102	450	6/24	5902062038234

TOP TOOLS

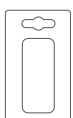

Ref.	L [mm]	☒	EAN
10A750	180	20/60	5902062038609

Piła kabłąkowa

Bow saw / Bogensäge / Ножовка лучковая / Ножівка лучкова / Fűrész keretes / Ferestrău cu arc / Oblouková pila / Pilka rámová / Žaga lokarica / Pjūklas rēminis / Lokzāģis / Vibusaag / Трион бичиця / Pila za drvo / Testera za drvo / Τοξοπίο / Sierra de arco / Segá ad arco / Serra de arco / Scie à archet / Boogzaag

VERTO

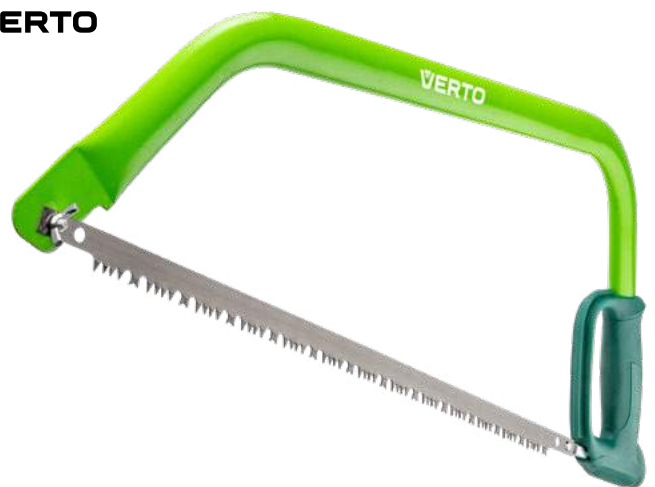

Ref.	L [mm/"]	☒	EAN
15G154	530/21	12/24	5902062050472
15G155	760/30	12/24	5902062050489
15G156	910/36	0/12	5902062050861

TOPEX



Ref.	L [mm/"]	☒	EAN
10A903	300	6/24	5902062102089
10A905	530	0/12	5902062101860
10A906	610	0/12	5902062101822
10A907	910	0/12	5902062101839

Brzeczot do piły kabłąkowej

Blade for bow saw / Sägeblatt für Bogensäge / Полотно для лучковой пилы / Полотно до пилки лучкової / Lap keretesfűrészhez / Pânză pentru ferăstrău cu ramă / Pilový list pro obloukovou pilu / Čepel oblúčovej píly / Žagni list za ločno žago / Geležtē, lenktam pjūklui / Lokzāģa asmens / Vibusaes saeleht / Лента за лъков трион / Oštrica za ručnu žagu / Sečiva za lučnu testeru / Прионόλαμα για τοξοειδές πριόνι / Hoja de sierra de arco / Lama per sega ad arco / Lâmina p. Serra / Lame de scie pour scie à archet / Mesblad voor boogzaag

TOPEX



Ref.	L [mm]	☒	EAN
10A915	530	0/240	5902062101938
10A916	610	0/240	5902062101945
10A917	760	0/240	5902062101952



Siekiera

Axe / Axt / Topor / Сокрупа / Balta / Topor / Sekera / Sekera / Sekira / Kirvis / Cirvis / Kirves / Брахда / Sjekira / Sekira / Ταξκούρι / Hacha / Ascia / Machado / Hache / Bijl

NEO
TOOLS

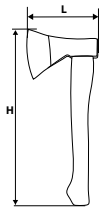

Ref.	m [g]	H [mm]	L [mm]	☒	EAN
27-006	600	360	145	6/24	5907558400489
27-008	800	380	165	6/24	5907558400496
27-010	1000	400	175	6/12	5907558400502

NEO
TOOLS



Ref.	m [g]	H [mm]	L [mm]	☒	EAN
27-019	2000	700	195	0/4	5907558407341

NEO
TOOLS



Ref.	m [g]	H [mm]	L [mm]	☒	EAN
27-033	1700	710	185	4/8	5907558431407

VERTO



Ref.	L ["]	m1 [g]	m2 [g]	☒	EAN
05G102	9"	550	410	6/24	5902062050496
05G100	14"	620	410	0/20	5902062037671
05G101	17.5"	870	540	0/20	5902062038562
05G103	28"	1350	800	4/8	5902062050588
05G104	28"	1510	1000	4/8	5902062050595

VERTO



Ref.	L [mm]	m1 [g]	m2 [g]	☒	EAN
05G202	880	2500	1500	0/4	5902062038586

NEO
TOOLS



Ref.	m [g]	H [mm]	L [mm]	☒	EAN
27-012	1250	700	195	4/8	5907558400519

NEO
TOOLS



Ref.	m [g]	H [mm]	L [mm]	☒	EAN
27-030	400	355	120	12/24	5907558431377
27-031	700	445	140	6/12	5907558431384
27-032	850	600	160	6/12	5907558431391

NEO
TOOLS



Ref.	m [g]	H [mm]	L [mm]	☒	EAN
27-120	600	140	367	6/24	5907558454840
27-121	800	162	370	6/24	5907558454857
27-123	1250	195	868	0/12	5907558454871
27-124	1500	195	880	0/12	5907558454888

VERTO



Ref.	L [mm]	m1 [g]	m2 [g]	☒	EAN
05G201	370	860	600	4/16	5902062038579

VERTO



Ref.	L [mm]	m1 [g]	m2 [g]	☒	EAN
05G203	880	3900	2700	0/2	5902062038593

Siekiera

Axe / Axt / Топор / Сокира / Balta / Topor / Sekera / Sekera / Sekira / Kirvis / Cirvis / Kirves / Брџаџа / Sjekira / Секира / Ταεκούρι / Hacha / Ascia / Machado / Hache / Bijl

TOPEX



Ref.	m [g]	H [mm]	L [mm]	DIN	☒	EAN
05A136	600	360	150	5131	0/24	5902062103314
05A138	800	380	165	5131	6/24	5902062103321
05A140	1000	610	180	5131	0/12	5902062103338
05A142	1250	710	200	7294	0/12	5902062103345
05A146	1600	810	215	7294	0/8	5902062103352

TOPEX



Ref.	m [g]	H [mm]	L [mm]	DIN	☒	EAN
05A220	600	144	377	5131	6/24	5902062510112
05A221	800	160	401	5131	6/18	5902062510129
05A222	1000	172	450	5131	0/6	5902062510150
05A223	1250	184	860	5131	0/6	5902062510167

TOPEX



Ref.	m [g]	H [mm]	L [mm]	☒	EAN
05A148	2000	800	200	0/6	5902062032065

TOP TOOLS



Ref.	m [g]	☒	EAN
05A306	600	0/24	5902062100436
05A308	800	0/12	5902062104618
05A310	1000	0/12	5902062100849
05A312	1250	0/12	5902062100443

TOP TOOLS



Ref.	m [g]	☒	EAN
05A206	600	0/20	5902062101334
05A208	800	0/12	5902062104595
05A210	1000	0/12	5902062104601
05A212	1250	0/10	5902062101341

Młoto-siekiera

Splitting maul / Hammer-Axt / Колун / Сокира з довшим рукоўям / Fejsze / Topor pentru despicat / Kládiová sekera / Kládiová sekera / Kládivo-sekira / Plaktukas-kirvis / Cirvis skaldīšana / Haamrīga kirves / Чук-брадвичка / Їекиќ-ѕјекира / Їекиќ-ѕјекира / Ταεκούρι τεμαχισού / Martillo-hacha / Ascia / Martelo-Machado / Hache-marteau / Hamer-bijl

NEO TOOLS



Ref.	m [g]	H [mm]	L [mm]	☒	EAN
27-050	2500	900	200	0/4	5907558409901

Toporek uniwersalny

Hatchet / Universabeil / Топорик универсальный / Сокира універсальна / Gipszvágoálta / Toporaz / Sekerka univerzální / Sekerka tesárska / Sekira / Universalus kirvis / Cirvis universáls / Kirves / Чук-брадџа / Їекиќ-ѕјекира / Sekira / Πελέκι γενικής χρήσης / Hacha universal / Ascia / Machada universal / Merlin universal / Universele handbijl

TOPEX



Ref.	m [g]	H [mm]	L [mm]	☒	EAN
02A110	600	323	173	6/24	5902062102621

Trzonek

Shank / Stiel / Рукоятка / Хвостовик / Baltanyél / Mânier / Násada / Třň / Ročaj / Kotas / Spals / Vars / Цокъл / Držak / Drška, držalo / Χειρολαβή / Vástago / Manico per ascia / Cabo / Manche / Handvat



Ref.	do siekier	L [mm]	☒	EAN
05A436	600g	360	0/50	5902062948700
05A450	800g	500	0/25	5902062948717
05A460	1000g	600	0/25	5902062948724
05A470	1250g	700	0/25	5902062948731

Maczeta ogrodowa

Garden machete / Gartenmachete / Мачете для садових работ / Мачете садові / Kerti bozátvágó / Macetă de grădină / Zahradní mačeta / Záhradná mačeta / Vrtna mačeta / Mačete sodui / Dārza mačete / Αίματσίεετε / Градинско мачете / Маčета за крчење / Маčета за rastinje / Ματσίετα κήπου / Machete de jardineria / Machete da giardino / Machete de jardim / Manchette de jardin / Kapmes

VERTO

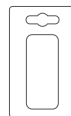

Ref.	L ["]	☒	EAN
15G191	18	0/48	5902062050755

VERTO

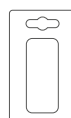

Ref.	L ["]	☒	EAN
15G190	19	0/48	5902062050748

Szpadel

Spade / Spaten / Застын / Лопата багнетова / Ásó nyelezve / Lopáticã / Rýč / Rýl' lichobežníkový / Lopata / Kastuvas / Lápsta / Labidas / Лопата права / Lopata / Lopata / Φυάρι / Pala / Pala / Pá / Louchet / Spade

NEO
TOOLS



Ref.	☒	EAN
95-007	0/6	5907558433623
95-008	0/6	5907558433616

VERTO



Ref.	☒	EAN
15G010	0/6	5902062038470
15G011	0/6	5902062038487

VERTO



Ref.	☒	EAN
15G001	0/6	5902062038241
15G002	0/6	5902062038258

VERTO



Ref.	☒	EAN
15G014	0/6	5902062050779

VERTO



Ref.	☒	EAN
15G003	0/6	5902062038265
15G004	0/6	5902062038272

T TOPEX



Ref.	☒	EAN
15A040	0/1	5902062150110

Saperka skladana

Trenching shovel / Pionierspaten / Саперная лопата / Лопатка саперна / Ásó tábori / Lopatã micã / Rýč / Malã lopatka / Lopata / Kastuvėlis / Sapiera lãpsta / Sapõõrilabidas / Малка нехотна лопата / Lopatica / Pionirski ašov / Φτυάρι λαμού / Pala de trinchera / Pala ripiegabile / Pã pequena / Pelle à manche court

TOPEX

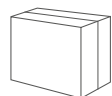

Ref.	☒	EAN
15A075	0/12	5902062038432

Łopata piaskowa

Sand shovel / Sandspaten / Лопата совковая / Лопата совкова / Lapát nyelezett / Lopatã pentru nisip / Lopata na pisek / Lopata na piesok / Lopata za pesek / Kastuvus smėliui / Lãpsta / Liivalabidas / Лопата за пясък / Lopata za pijesak / Lopata za pesak / Φτυάρι τετράγωνο / Pala cuadrada / Pala per sabbia / Pã de rotor / Aube de rotor / Zandschep

NEO TOOLS



Ref.	☒	EAN
95-011	0/6	5907558433609

Łopata

Shovel / Schaufel / Лопата / Лопата совковая / Lapát nyelezve / Lopatã / Lopata / Lopata ocelovã / Lopata / Kastuvus / Lãpsta / Kùhvel / Лопата крива / Lopata / Lopata / Φτυάρι / Pala / Badile / Pã / Pelle / Schep

VERTO



Ref.	☒	EAN
15G012	0/6	5902062038449

Łopatka

Garden trowel / Kleiner spaten / Лопатка / Лопатка / Kislapát / Lopata pentru zapada / Lopata na snih / Lopata na sneh / Lopata za sneg / Kastuvus sniegui / Lãpsta sniegam / Lumelabidas / Лопатка / Lopatica / Lopata za sneg / Φτυάρι για το χιόνι / Hombro / Spalla / Ombrò / L'épaule / Schepje

VERTO



Ref.	L [mm]	☒	EAN
15G405	340	6/36	5902062037442
15G406	350	6/36	5902062037459

Pazaruki

Hand cultivator / Handkultivator / Тяпка посадочная / Розпушувач / Talajlazító / Cultivator / Kypřič / Kultivátor / Зубовý / Kultivator / Purentuvus / Kultivãtors / Kultivaator / Κυλληματορ εργαδικοσ / Kultivator / Kultivator / Φρεζάρτορο / Rastrillo pequeño / Coltivatore / Garras / Griffes / Kweker



Ref.	L [mm]	☒	EAN
15G408	365	6/36	5902062037442

Grabki

Small rake / Kleiner rechen / Грабелъки / Грабелъки / Gereblye mini / Greblã / Hrable / Hrabličky / Grabljice / Grėbliukas / Grãbeklis / Reha / Градинарско зребло / Grablje / Grabljice / Τσουγκράνα / Rastrillo / Rastrellino / Forquilhas / Petit rãteau

VERTO



Ref.	L [mm]	☒	EAN
15G407	340	6/36	5902062037466

Grabie do liści

Garden rake / Laubbesen / Грабли для листьев / Грабли садови / Lombseprű / Grebla gradina / Hrábě na listí / Hrable na listie / Grablje za listje / Greblys lapams / Grãbeklis lapãm / Aiareha / Гребло градинско / Grablje za lišće / Grabulje / Τσουγκράνα για μάζεμα φύλλων κηπου / Rastrello per foglie / Forquilhas p. folhas / Rãteaux à feuilles / Bladhark

VERTO



Ref.	L [cm]	☒	EAN
15G053	164	0/1	5902062045348
15G054	166	0/1	5902062045355

Grabie

Rake / Rechen / Грабли / Грабни / Gereblye / Greblä / Hrábě / Hrable / Grablje / Gräblys / Gräbeklis / Reha / Гребло / Grablje / Grablje / Τσουγκράνα / Rastrillo / Rastrello / Ancinho / Râteaux / Hark

VERTO



Ref.	L [cm]	☒	EAN
15G050	132	0/1	5902062045379

VERTO



Ref.	L [cm]	☒	EAN
15G052	123	0/20	5902062045423

VERTO



Ref.	L [cm]	☒	EAN
15G051	166	0/1	5902062045386

Motyczka

Small hoe / Handhacke / Тяпка / Сапка / Últetó kapra / Грабъ / Motyčka / Motyčka / Motika / Каптуркас / Карлис / Kõblas / Мотична градинска / Motika / Motika / Τσάνα / Zappa / Enxada / Houlette / Schoffel

VERTO

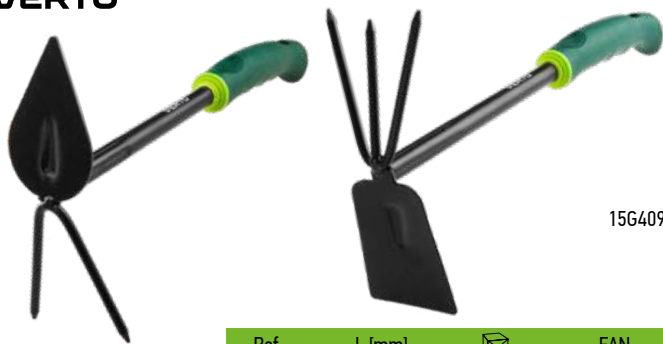

15G409

Ref.	L [mm]	☒	EAN
15G409	340	6/36	5902062037480
15G410	340	6/36	5902062037572

Motyka

Hoe / Handhacke / Мотыжна / Сапка / Кара / Säräligä / Motyka / Motyčka / Motika / Purentuvas / Карлис / Kõblas / Мотика / Motika / Motičica / Σκαλιστήρι / Azada / Zappetta / Enxada / Brosse à joints

VERTO

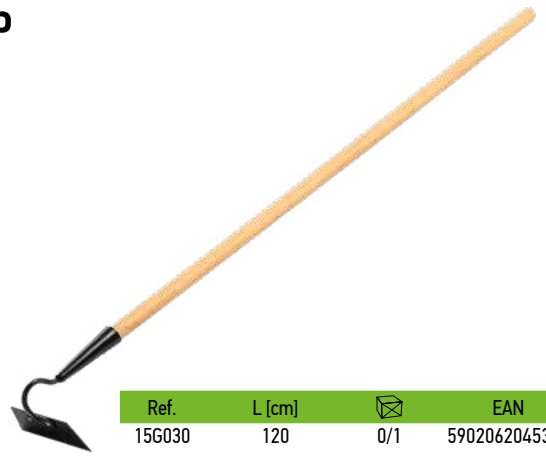

Ref.	L [cm]	☒	EAN
15G030	120	0/1	5902062045362

VERTO



Ref.	L [cm]	☒	EAN
15G031	136	0/30	5902062045393

VERTO



Ref.	m [g]	☒	EAN
15G033	1000	0/24	5902062050816
15G032	1133	0/24	5902062050809

Trzonek

Shank / Stiel / Рукотна / Хвостовик / Baltanyél / Mânier / Násada / Тіть / Ročaj / Kotas / Spals / Vars / Цокъл / Držak / Drška, držalo / Χειρολαβή / Vástago / Manica per ascia / Cabo / Manche / Handvat

VERTO



Ref.	L [cm]	☒	EAN
15G013	137	0/24	5902062050762

Widły

Fork / Gabel / Вилы / Buna / Vasvilla / Furcä / Vidle / Vidly záhradnícke / Vile / Šakės / Dakšas / Hark / Buna / Vile sa štilom / Vile / Δίκρανο / Forca / Forcado / Fourche / boormachine zonder slag

VERTO



Ref.	L [cm]	☒	EAN
15G040	127	0/6	5902062045409

VERTO



Ref.	L [cm]	☒	EAN
15G041	127	0/6	5902062045416

Obrzeże trawnika

Lawn edges / Rasenrand / Лента газонная (поребрик) / Стричка бар'єрна газонна / Ágyásszegély / Margine de poajște / Okraj travníku / Obruby na trávniky / Travníški robniki / Vejos krašto juosta / Zālāja armales / Muurääris / Кант за тревна площ / Rub za travnjake / Ivičnjak za travnjake / Ταμία οριοθέτησης γκαζόν / Borde para césped / Bordi per aiuole

VERTO



Ref.	Info	☒	EAN
15G510	10 cm x 9 m	0/24	5902062037312
15G511	15 cm x 9 m	0/24	5902062037329
15G512	20 cm x 9 m	0/24	5902062037336
15G513	10 cm x 9 m	0/24	5902062037343
15G514	15 cm x 9 m	0/24	5902062037350
15G515	20 cm x 9 m	0/24	5902062037367



Drut ogrodowy

Garden wire / Gartendraht / Проволока садовая / Дрим садовий / Kötözöğhuzal / Sārmā pentru grădină / Zahradní drát / Záhradný drôt / Vrtna žica / Sodo viela / Dārza stieples / Aiatraat / Ten gradinarска / Vrtna žica / Baštenska žica / Σύρμα κήπου / Alambre de jardín / Filo di ferro plastificato / Arame de jardín / Fil de jardin

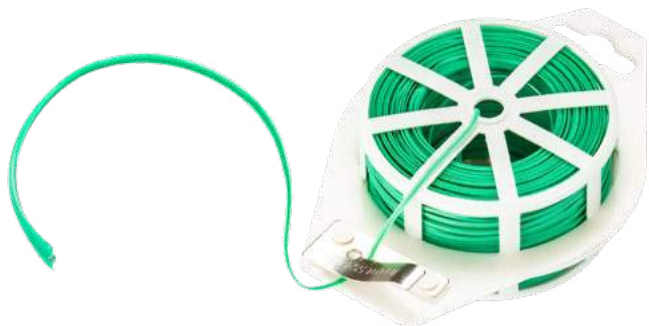

Ref.	Info	☒	EAN
15G530	1.5 mm x 50 m	24/96	5902062050427



Ref.	Info	☒	EAN
15G535	5 mm x 4 m	24/144	5902062050434

Gumofilce

Felt rubber boots / Filzgummstiefel / Сапоги резиновые с войлоком / Поєстяні черевуки на наукувоїй підошві / Filc csizma / Cizme din cauciuc cu păslă / Gumofilcové holinky / Filcové gumáky / Gumijasti škornji s filcem / Guminiai batai / Gumijas zábakai ar filcu / Voodriga kummikud / Работни гумену ботуши с филц / Gumene cizme s filcom / Gumene cizme / Μπότες λαστινέες με κελτέ / Botas de agua con fieltro / Calosce con feltro / Galochas com feltro / Bottes en caoutchouc avec doublure en feutre / Rubberlaarzen

VERTO



ANTISLIP SOLE
АНТИПОСЛИЗГОВА ПОДЕШВА
АНТИКОСЛЬЩАЮЩА ПОДОШВА



WARMING INSERT
ОСІЕПЛЯНИ WKŁAD
УТЕПЛЕННАЯ СТЕЛКА

Ref.	size	☒	EAN
15G900	39	0/6	5902062039576
15G901	40	0/6	5902062039583
15G902	41	0/6	5902062039590
15G903	42	0/6	5902062039606
15G904	43	0/6	5902062039613
15G905	44	0/6	5902062039620
15G906	45	0/6	5902062039637
15G907	46	0/6	5902062039644
15G908	47	0/6	5902062039651

Kalosze EVA

EVA rubber boots / Gummstiefel EVA / Галошы ЭВА / Чоботу EVA / EVA gumicsizma / Cizme cauciuc EVA / Holinky EVA / Gumáky EVA / Galoše EVA / Gmimniai batai EVA / Galošas EVA / Kummikud EVA / Гумену ботуши EVA / Gumene cizme EVA / EVA cizme za kišu / Γαλότσες από EVA / Botas de agua EVA / Calosce in EVA / Galochas de em EVA / Bottes en caoutchouc EVA / EVA Laarzen

VERTO



ANTISLIP SOLE
АНТИПОСЛИЗГОВА ПОДЕШВА
АНТИКОСЛЬЩАЮЩА ПОДОШВА



REPLACEMENT WARMING INSERT
WYMIENNY WKŁAD OSIEPŁANY
СМЕННАЯ УТЕПЛЕННАЯ СТЕЛКА

Ref.	size	☒	EAN
15G930	40	0/6	5902062039729
15G931	41	0/6	5902062039736
15G932	42	0/6	5902062039743
15G933	43	0/6	5902062039750
15G934	44	0/6	5902062039767
15G935	45	0/6	5902062039774
15G936	46	0/6	5902062039781
15G937	47	0/6	5902062039798

Ochroniacz słuchu, głowy i wzroku - 3 w 1

Head, eyes and hearing protector - 3 in 1 / Gehör-, Kopf- und Augenschutz - 3 in 1 / Средство защиты слуха, головы и зрения - 3 в 1 / Zaciб захисту слуху, голови та зору — 3 в 1 / Hallás, fej és szemvédelem - 3 az 1-ben / Protecție auz, cap și vedere - 3 în 1 / Chráníč sluchu, hlavy a očí - 3 v 1 / Chráníč sluchu, hlavy a zraku - 3 v 1 / Varovalo sluha, glave in vida - 3 v 1 / Trys viename - klausos organu, galvos ir regos apsauga / Galvas, dzirdes un redzes aizsargs - 3 vienā / Kõrvade, pea ja silmade kaitse - 3 in 1 / Зашуца на слуха, глaвaтa и зрeнeнeтo - 3 в 1 / Štitník sluha, glave i očiju - 3 u 1 / Zaštitna za sluh, glavu i vid - 3 u 1 / Μέσο προστασίας ακοής, κεφαλής και όρασης: 3 σε 1 / Protector de oído, cabeza y vista - 3 en 1 / Dispositivo di protezione dell'udito, della testa e della vista - 3 in 1 / Beschermers van het gehoor, hoofd en zicht - 3 in 1

VERTO



Ref.	☒	EAN
97H300	0/12	5902062042262

Pas narzędziowy

Tool belt / Werkzeuggürtel / Сумка для инструмента на пояс / Пасок інструментальний / Szerszámtartó öv / Bandă azeviză / Montérský pás / Opasok na náradie / Pas za orodje / Monterio diržas / Instrumentu josta / Liimimispressi lint / Колан на инструменти / Pojas za alat / Pojas torbica / Ζώνη μονταρίματος / Cinturón para herramientas reforzado / Cintura per montatore / Cinto p. montagem / Ceinture de monteure / Montageriem



VERTO

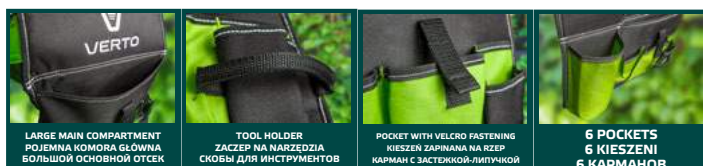

LARGE MAIN COMPARTMENT
POJEMNA KOMORA GŁÓWNA
БОЛЬШОЙ ОСНОВНОЙ ОТСЕК

TOOL HOLDER
ZÁČEP NA NÁRZEDZIA
СКОБЫ ДЛЯ ИНСТРУМЕНТОВ

POCKET WITH VELCRO FASTENING
KIESZEN ZAPNIANA NA KZEP
КАРМАН С ЗАСТЕЖКОЙ-ЛИПУШКОЙ

6 POCKETS
6 KIESZENI
6 КАРМАНОВ

Ref.	info	☒	EAN
15G550	6 pockets	0/30	5902062039002

Rękawice robocze

Working gloves / Arbeitshandschuhe / Перчатки рабочие / Руквици работчи / Bőr kesztyű / Mănuși de lucru / Pracovní rukavice / Pracovné rukavice / Delovne rokavice / Darbo pirštines / Darba cimdi / Töökindad / Ръкавици работни / Radne rukavice / Radne rukavice / Γάντια εργαίας / Guantes de trabajo / Guanti di lavoro / Luvas de trabalho / Gants de travail / Werkhandschoenen



Ref.	size	☒	EAN
97H120	8"	12/120	5902062034021
97H121	9"	12/120	5902062035486
97H122	10"	12/120	5902062035493



Ref.	size	☒	EAN
97H136	8"	0/120	5902062054531
97H137	9"	0/120	5902062054548
97H138	10"	12/120	5902062054555



Ref.	size	☒	EAN
97H140	7"	0/120	5902062055729
97H141	8"	0/120	5902062054517
97H142	9"	12/120	5902062054524



Ref.	size	☒	EAN
97H151	8"	0/120	5902062039460
97H152	9"	0/120	5902062039477
97H153	10"	12/120	5902062054562

T TOPEX

ZABEZPIECZENIA
PROTECTION **БЕЗОПАСНОСТЬ**

DeFort™

HARDENED

Klódka

Padlock / Vorhängeschloss / Замок навесной / Замок нависний / Lakat / Lacăt / Visací zámek / Visiaci zámok / Kľučavnica / Spyna / Piekaramā slēdzene / Tabalukk / Натинар / Lokot / Katanac / Λουκέτο / Candado / Lucchetto / Cadeado / Cadenas / Hangslot

DeFort

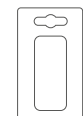
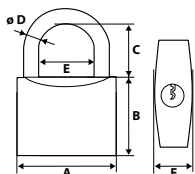

Ref.	A [mm]	B [mm]	C [mm]	D [mm]	E [mm]	F [mm]	📦	EAN
90U108	50	38	20	9	27	25	12/72	5902062208408
90U109	60	43	20	10	34	34	12/72	5902062208415

DeFort

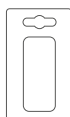
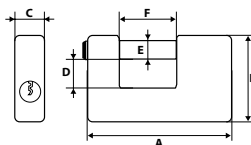

Ref.	A [mm]	B [mm]	C [mm]	D [mm]	E [mm]	F [mm]	📦	EAN
90U330	50	45	20	12	9	18,5	12/72	5902062903303
90U332	70	50	20	17	10	26	6/48	5902062903327
90U333	90	55	20	17,5	12	31	6/24	5902062903334

TOP TOOLS

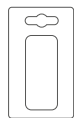

Ref.	W [mm]	📦	EAN
90U270	30	12/240	5902062902702
90U271	40	12/120	5902062902719
90U272	50	6/60	5902062902726
90U273	60	6/60	5902062902733

TOP TOOLS

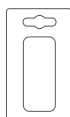

Ref.	W [mm]	📦	EAN
90U263	90	6/36	5902062902634

TOP TOOLS

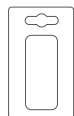

Ref.	W [mm]	📦	EAN
90U280	40	12/120	5902062902801
90U281	50	6/96	5902062902818

TOP TOOLS

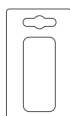

Ref.	W [mm]	📦	EAN
90U300	30	12/192	5902062903006
90U301	40	6/96	5902062903013
90U302	50	12/72	5902062903020
90U303	60	10/60	5902062903037
90U304	75	10/40	5902062903044

Wkładka profilowa

Profile liner / Profileinlage / Профилированный вкладыш / Органиайзер / Profilbetét / Patron profilat / Profilová vložka / Profilová vložka / Profilni vložek / Profiliuota dėklė / profilēts ielīknis / Profiltihend / Профилна вложка / uložak za bravu / Profilisani uložak / Διατάρητο ένθεμα / Bandeja clasificadora perfilada / Inserto perfilato / Cartucho perfilado / Insert profilé / Geprofileerde inlegger

TOP TOOLS

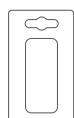

Ref.	L [mm]	📦	EAN
90U460	62 (31/31)	12/120	5902062904607

Klódka szyfrowa

Code padlock / Chiffrevorhängeschloss / Замок кодовый / Замок нависний кодовый / Számzáras lakat / Lacăt / Visací zámek kódovaný / Visiaci zámok, kódovací / Kľučavnica z geslom / Kodinē spyna / Piekaramā slēdzene ar kodu / Koodiga tabalukk / Натинар / Lokot / Katanac / Λουκέτο με κωδικό / Candado con código para maletas / Lucchetto / Cadeado de código / Cadenas à codes / Code hangslot

TOP TOOLS

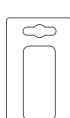

Ref.	W [mm]	📦	EAN
90U212	21	12/288	5902062230164
90U214	22	0/24	5902062230171

Linka rowerowa

Bike lock / Fahrradseil / Замок велосипедный / Замок велосипедный / Kerékpárlakat / fixator bicicletă / Zámek jíz. Kola lankový / Zámok na bicykel / Kľučavnica za kolo / Spyna dviračiji / Veloslédzene / Rattalukk / Katanac za biciklo / Σπάγκος για κλειδωμα ποδηλάτου / Catena per bicicletta / Corda para bicicleta / Câble à vélo / Fietsslot



Ref.	L [cm]	Ø [mm]	📦	EAN
90U245	80	12	0/20	5902062220073

Identyfikatory do kluczy

Key labels / Schilder für Schlüssel / Бирки для ключей / Бірки до ключів / Kulcscímkék / Suport chei / Visačky na kľúče / Identifikatory na kľúče / Identifikatorji za kľuče / Raktų identifikatoriai / Atslėgu identifikatori / Võtmeidentifikaator / Идентификатори за ключове / Identifikatori za kľučevе / Identifikator za kľučevе / Καρτελάκια κλειδιών / Etiquetas para llaves / Identificatore per chiavi / Identificadores p. Chaves / Etiquettes pour clés / Sleutellabels



x12



Ref.	📦	EAN
90U250	50/200	5902062208569

Plombownica

Sealing tongs / Plombenzange / Клещи plombировочные / Кліщі для plombування / Plombázó fogó / Masă de etanșare / Plombovací kleště / Plombovací klešte / Klešče za plombiranje / Plombavimo replės / Plombētājs / Isolatsioonitangid / Клещи за plombиране / Klijesta za plombiranje / Klesta za plombiranje / Ταμπόδες συγκόλλησης / Tenazas de sellado / Pinza per plombature / Máquina de lacrar / Pince à plomber / Vergrendeling



Ref.	L [mm]	📦	EAN
90U256	17	0/80	5902062200372

Ref.	Str.	Ref.	Str.	Ref.	Str.	Ref.	Str.	Ref.	Str.	Ref.	Str.	Ref.	Str.	Ref.	Str.
01-010	27	01-185	123	01-528	331	02A010	223	03-010	52	04-063	121	04A239	239		
01-011	27	01-186	123	01-529	331	02A012	223	03-011	52	04-071	121	04A240	239		
01-012	27	01-187	123	01-530	44	02A050	226	03-012	52	04-072	121	04A250	239		
01-013	27	01-188	123	01-531	44	02A057	226	03-013	52	04-073	121	04A260	239		
01-014	27	01-189	123	01-532	43	02A082	227	03-014	52	04-112	107	04A280	239		
01-015	28	01-190	123	01-533	43	02A083	227	03-015	52	04-113	107	04A312	239		
01-016	28	01-191	123	01-534	42	02A084	227	03-016	52	04-114	107	04A315	239		
01-017	29	01-192	123	01-535	124	02A085	227	03-017	52	04-115	107	05 114	166		
01-018	29	01-193	123	01-536	43	02A087	227	03-019	52	04-116	107	05 115	166		
01-019	30	01-194	123	01-537	43	02A088	227	03-020	52	04-117	107	05A136	374		
01-020	30	01-195	123	01-540	42	02A089	227	03-021	52	04-130	121	05A138	374		
01-021	33	01-200	35	01-550	40	02A110	374	03-022	52	04-131	121	05A140	374		
01-022	33	01-202	35	01-551	40	02A140	220	03-023	52	04-132	121	05A142	374		
01-025	344	01-203	35	01-555	44	02A160	220	03-024	52	04-133	121	05A146	374		
01-026	344	01-204	35	01A117	234	02A180	220	03-025	52	04-136	121	05A148	374		
01-027	344	01-216	36	01A118	234	02A201	225	03-026	52	04-137	121	05A206	374		
01-028	344	01-217	36	01A124	234	02A202	225	03-027	52	04-138	121	05A208	374		
01-085	34	01-220	38	01A130	234	02A203	225	03-028	52	04-139	121	05A210	374		
01-086	34	01-221	38	01A135	234	02A204	225	03-029	52	04-140	121	05A212	374		
01-087	34	01-223	38	01A218	234	02A205	225	03-030	94	04-142	122	05A220	374		
01-088	34	01-224	38	01A224	234	02A208	225	03-031	94	04-143	122	05A221	374		
01-089	34	01-225	38	01A425	235	02A210	225	03A136	237	04-171	98	05A222	374		
01-090	34	01-226	39	01A426	235	02A215	225	03A139	237	04-172	98	05A223	374		
01-091	34	01-227	38	01A427	235	02A220	225	03A149	237	04-173	98	05A306	374		
01-092	34	01-228	38	01A440	235	02A305	225	03A159	237	04-174	98	05A308	374		
01-093	34	01-229	39	01A445	236	02A310	226	03A169	238	04-175	98	05A310	374		
01-094	34	01-231	39	01A552	236	02A315	226	03A170	237	04-176	98	05A312	374		
01-095	34	01-232	38	01A554	236	02A320	226	03A171	237	04-177	99	05A436	374		
01-096	34	01-233	40	01A997	236	02A325	226	03A180	238	04-178	99	05A450	374		
01-101	32	01-234	41	01A998	236	02A330	223	03A225	237	04-179	99	05A460	374		
01-102	31	01-235	40	01A999	236	02A343	225	03A230	237	04-180	99	05A470	374		
01-103	31	01-236	40	02-001	302	02A344	225	03A235	237	04-181	99	05G100	373		
01-105	33	01-237	41	02-005	49	02A345	225	03A245	238	04-182	99	05G101	373		
01-106	32	01-240	38	02-010	49	02A347	225	03A320	237	04-183	99	05G102	373		
01-110	124	01-241	38	02-020	50	02A354	225	03A325	237	04-184	99	05G103	373		
01-111	124	01-242	38	02-030	330	02A355	225	03A440	238	04-185	99	05G104	373		
01-112	124	01-243	39	02-031	330	02A401	224	03A441	238	04-186	100	05G201	373		
01-113	124	01-244	39	02-032	330	02A402	224	03A442	238	04-187	100	05G202	373		
01-114	124	01-245	39	02-040	49	02A403	224	03A445	238	04-188	100	05G203	373		
01-115	124	01-250	27	02-041	49	02A405	224	03A490	257	04-189	100	06-011	119		
01-116	124	01-251	27	02-042	49	02A408	224	04-001	98	04-190	100	06-020	119		
01-117	124	01-252	27	02-044	49	02A410	224	04-002	98	04-191	103	06-036	119		
01-118	124	01-253	27	02-050	51	02A415	224	04-003	98	04-192	103	06-037	119		
01-119	124	01-254	28	02-051	49	02A420	224	04-004	98	04-193	103	06-040	119		
01-120	124	01-255	28	02-052	49	02A511	224	04-006	99	04-194	103	06-070	118		
01-121	124	01-256	29	02-053	49	02A530	224	04-007	99	04-196	106	06-071	118		
01-122	124	01-257	29	02-054	49	02A540	224	04-011	98	04-197	106	06-072	118		
01-123	124	01-306	124	02-055	49	02A550	224	04-012	98	04-200	120	06-073	118		
01-124	124	01-307	124	02-060	49	02A560	224	04-013	98	04-201	105	06-075	118		
01-125	124	01-308	123	02-066	51	02A580	224	04-014	98	04-204	102	06-078	118		
01-126	124	01-309	123	02-069	49	02A625	222	04-015	98	04-206	102	06-079	112		
01-127	124	01-310	125	02-072	51	02A635	222	04-016	98	04-207	102	06-101	114		
01-128	124	01-311	125	02-073	50	02A645	222	04-019	100	04-208	102	06-103	113		
01-129	124	01-400	41	02-074	50	02A655	222	04-020	100	04-209	105	06-104	113		
01-150	35	01-401	45	02-075	50	02A665	222	04-021	99	04-210	106	06-105	113		
01-151	35	01-402	302	02-076	50	02A675	222	04-022	99	04-211	106	06-106	113		
01-152	27	01-500	42	02-077	50	02A706	221	04-023	99	04-212	112	06-107	83		
01-153	27	01-501	43	02-078	50	02A708	221	04-024	99	04-213	102	06-108	110		
01-154	28	01-502	43	02-106	48	02A715	224	04-025	99	04-214	102	06-111	108		
01-155	28	01-503	44	02-107	48	02A832	224	04-026	99	04-220	122	06-112	110		
01-156	29	01-505	43	02-108	48	02A833	224	04-028	101	04-221	122	06-114	110		
01-157	29	01-506	43	02-109	316	02A835	224	04-031	99	04-222	122	06-115	109		
01-158	29	01-507	43	02-111	48	02A838	224	04-032	99	04-225	107	06-116	109		
01-160	35	01-509	32	02-112	48	02A840	224	04-033	99	04-227	107	06-118	111		
01-162	35	01-510	45	02-120	48	02A850	221	04-034	99	04-228	108	06-119	110		
01-165	236	01-511	45	02-121	48	02A855	220	04-035	99	04-230	120	06-120	111		
01-171	123	01-512	46	02-122	48	02A901	225	04-036	99	04-240	101	06-121	112		
01-172	123	01-513	45	02-123	48	02A902	225	04-037	120	04-250	120	06-122	110		
01-173	123	01-514	45	02-124	48	02A903	225	04-043	100	04A130	239	06-123	110		
01-174	123	01-515	45	02-126	48	02A904	225	04-044	100	04A140	239	06-124	112		
01-175	123	01-516	45	02-127	48	02A905	225	04-045	100	04A160	239	06-125	111		
01-176	123	01-517	45	02-128	48	02A906	225	04-046	100	04A175	239	06-126	111		
01-177	123	01-518	45	02-130	49	02A907	225	04-051	121	04A190	239	06-127	111		
01-180	123	01-519	42	02-131	49	02A910	223	04-052	121	04A210	239	06-128	114		
01-181	123	01-520	42	02-132	49	02A911	221	04-053	121	04A212	239	06-129	111		
01-182	123	01-524	41	02 366	142	02A912	220	04-054	121	04A230	239	06-130	111		
01-183	123	01-525	39	02 372	142	02A913	222	04-055	121	04A234	239	06A000	240		
01-184	123	01-526	331	02 562	142	02A930	227	04-062	121	04A236	239	06A010	240		

Ref.	Str.	Ref.	Str.	Ref.	Str.	Ref.	Str.	Ref.	Str.	Ref.	Str.	Ref.	Str.
06A015	240	08-049	55	08-239	53	08-429	54	08-540	57	08-736	80	09-057	92
06A020	240	08-050	55	08-240	53	08-430	54	08-543	57	08-740	80	09-058	92
06A025	240	08-051	55	08-241	53	08-431	54	08-546	57	08-741	80	09-059	92
06A130	240	08-052	55	08-242	53	08-432	54	08-550	60	08-742	80	09-060	92
06A230	240	08-053	55	08-243	53	08-442	54	08-551	60	08-743	80	09-061	92
06A250	240	08-054	55	08-244	53	08-443	54	08-552	60	08-744	80	09-062	92
06A330	241	08-055	55	08-245	53	08-444	54	08-553	59	08-745	80	09-063	92
06A430	240	08-056	55	08-246	53	08-445	54	08-554	60	08-746	80	09-064	92
06A530	241	08-058	55	08-247	53	08-446	54	08-555	59	08-750	81	09-065	92
06A615	227	08-061	63	08-251	60	08-447	54	08-556	59	08-751	81	09-066	92
06A625	240	08-070	56	08-252	60	08-448	54	08-557	60	08-752	81	09-067	92
06A635	227	08-071	56	08-253	60	08-449	54	08-558	60	08-753	81	09-068	92
06A721	240	08-072	56	08-254	60	08-450	54	08-559	59	08-754	81	09-069	92
06A722	240	08-073	56	08-255	60	08-451	54	08-560	59	08-755	81	09 096 924	165
06A723	240	08-074	56	08-256	59	08-452	54	08-562	60	08-756	81	09 102	165
06A724	240	08-075	56	08-300	55	08-453	54	08-563	60	08-757	81	09 116	165
06A725	240	08-076	56	08-301	55	08-454	54	08-564	60	08-758	81	09 124	165
06A786	241	08-077	56	08-302	55	08-458	54	08-565	60	08-759	81	09 126	165
06A788	241	08-078	56	08-303	55	08-459	54	08-580	57	08-760	81	09-141	94
06A831	241	08-080	56	08-304	55	08-460	54	08-581	57	08-761	81	09-143	94
06A832	241	08-081	56	08-305	55	08-461	54	08-582	57	08-762	81	09-145	94
06A833	241	08-082	56	08-306	55	08-462	54	08-583	57	08-763	81	09-147	94
07 605	166	08-083	56	08-307	55	08-463	54	08-584	57	08-764	81	09-149	94
07 621	166	08-084	56	08-308	55	08-464	54	08-585	57	08-765	81	09-151	94
07 622	166	08-085	56	08-309	55	08-465	54	08-586	57	08-766	81	09-176	94
07 623	166	08-086	56	08-311	55	08-466	54	08-587	57	08-767	81	09-203	96
07A107	236	08-090	147	08-312	55	08-467	54	08-588	57	08-770	80	09-205	96
07A110	236	08-091	147	08-313	55	08-468	54	08-589	57	08-771	80	09-207	96
07A112	236	08-151	60	08-314	55	08-469	54	08-590	57	08-772	80	09-208	96
07A115	236	08-152	60	08-315	55	08-470	54	08-591	57	08-773	80	09-210	96
07A206	237	08-153	60	08-316	55	08-471	54	08-592	57	08-774	80	09-212	96
07A210	237	08-154	60	08-317	55	08-472	54	08-593	57	08-775	80	09-214	96
07A212	237	08-155	59	08-318	55	08-473	54	08-594	57	08-776	80	09-302	96
07A215	237	08-168	54	08-319	55	08-474	54	08-595	57	08-777	80	09-320	92
07A306	237	08-170	54	08-320	56	08-475	54	08-596	57	08-778	80	09-321	92
07A307	237	08-171	54	08-321	56	08-476	54	08-597	57	08-780	80	09-322	92
07A310	237	08-172	54	08-322	56	08-477	54	08-598	57	08-781	80	09-323	92
07A415	259	08-173	54	08-323	56	08-478	54	08-599	57	08-782	80	09-324	92
07A420	259	08-174	54	08-324	56	08-479	54	08-603	73	08-783	80	09-325	92
07A430	259	08-175	54	08-325	56	08-480	54	08-649	82	08-784	80	09-326	92
07A431	259	08-176	54	08-326	56	08-481	54	08-650	57	08-821	89	09-327	92
07A432	259	08-177	54	08-327	56	08-482	54	08-651	57	08-823	89	09-328	92
07A433	259	08-178	54	08-328	56	08-486	54	08-652	61	08-824	89	09-329	92
08-008	55	08-179	54	08-329	56	08-487	54	08-653	61	08-825	89	09-330	92
08-009	55	08-180	54	08-331	56	08-488	54	08-654	61	08-826	89	09-331	92
08-010	55	08-181	54	08-332	56	08-489	54	08-660	62	08-827	89	09-333	92
08-011	55	08-182	54	08-333	56	08-490	54	08-661	63	08-828	89	09-334	92
08-012	55	08-184	54	08-335	56	08-491	54	08-662	64	08-830	89	09-336	92
08-013	55	08-185	54	08-340	55	08-492	54	08-663	64	08-835	89	09-338	92
08-014	55	08-186	54	08-341	55	08-493	54	08-664	66	08-837	89	09-339	92
08-015	55	08-187	54	08-350	60	08-494	54	08-665	66	08-910	71	09-340	92
08-016	55	08-188	54	08-351	60	08-495	54	08-666	67	08-915	72	09-341	92
08-017	55	08-189	54	08-352	60	08-496	54	08-667	67	08-920	77	09-342	92
08-018	55	08-190	54	08-353	59	08-497	54	08-668	68	08A108	252	09-360	94
08-019	55	08-191	54	08-355	58	08-498	54	08-671	69	08A110	252	09-361	94
08-020	55	08-192	54	08-356	59	08-499	54	08-672	65	08A115	246	09-362	94
08-021	55	08-193	54	08-357	59	08-501	58	08-673	65	08A422	253	09-363	94
08-022	55	08-194	54	08-408	54	08-502	58	08-674	62	08A424	253	09-364	94
08-023	55	08-195	54	08-409	54	08-503	57	08-679	63	08A426	253	09-365	94
08-024	55	08-196	54	08-410	54	08-504	57	08-680	68	08A428	253	09-366	94
08-025	55	08-197	54	08-411	54	08-506	58	08-681	70	08A430	253	09-367	94
08-026	55	08-220	53	08-412	54	08-507	57	08-690	62	08A434	253	09-368	94
08-027	55	08-221	53	08-413	54	08-508	57	08-692	61	08A606	253	09-406	90
08-028	55	08-222	53	08-414	54	08-511	58	08-694	61	08A608	253	09-407	90
08-029	55	08-223	53	08-415	54	08-512	58	08-705	80	08A610	253	09-408	90
08-030	55	08-224	53	08-416	54	08-513	58	08-706	80	08A612	253	09-409	90
08-032	55	08-225	53	08-417	54	08-514	58	08-707	81	08A615	253	09-410	90
08-036	55	08-226	53	08-418	54	08-515	58	08-708	81	09-042	92	09-411	90
08-039	55	08-227	53	08-419	54	08-516	58	08-710	83	09-043	92	09-412	90
08-040	55	08-228	53	08-420	54	08-519	58	08-711	82	09-044	92	09-413	90
08-041	55	08-229	53	08-421	54	08-520	57	08-712	174	09-045	92	09-414	90
08-042	55	08-230	53	08-422	54	08-521	57	08-713	81	09-046	92	09-415	90
08-043	55	08-231	53	08-423	54	08-523	58	08-730	80	09-051	92	09-416	90
08-044	55	08-232	53	08-424	54	08-524	58	08-731	80	09-052	92	09-417	90
08-045	55	08-235	53	08-425	54	08-525	58	08-732	80	09-053	92	09-418	90
08-046	55	08-236	53	08-426	54	08-530	57	08-733	80	09-054	92	09-419	90
08-047	55	08-237	53	08-427	54	08-533	57	08-734	80	09-055	92	09-420	90
08-048	55	08-238	53	08-428	54	08-536	57	08-735	80	09-056	92	09-421	90

Ref.	Str.	Ref.	Str.	Ref.	Str.	Ref.	Str.	Ref.	Str.	Ref.	Str.	Ref.	Str.
09-422	90	09-728	90	09A412	241	10A713	231	11-238	141	11-555	142	11-867	150
09-423	90	09-729	90	09A414	241	10A715	232	11-239	141	11-560	142	11-868	150
09-424	90	09-730	90	09A416	241	10A717	231	11-240	141	11-561	142	11-869	150
09-425	90	09-732	90	09A420	241	10A717P	231	11-241	141	11-600	163	11-870	150
09-426	90	09-734	90	09A425	241	10A719	231	11-242	139	11-601	163	11-871	150
09-427	90	09-736	90	09A432	241	10A722	232	11-243	139	11-610	158	11-872	150
09-428	90	09-738	90	10 564	165	10A723	232	11-250	137	11-611	158	11-873	150
09-429	90	09-741	90	10 597	165	10A725	232	11-261	138	11-612	158	11-880	133
09-430	90	09-746	90	10-900	83	10A733	232	11-262	138	11-614	158	11-881	133
09-432	90	09-747	90	10-902	83	10A750	372	11-263	138	11-620	223	11-882	133
09-512	84	09-748	90	10-904	83	10A760	232	11-264	138	11-621	223	11-883	134
09-513	85	09-749	90	10-906	83	10A761	232	11-265	139	11-625	223	11-884	134
09-514	87	09-750	90	10-908	83	10A762	232	11-266	139	11-634	226	11-885	135
09-515	85	09-751	90	10-910	83	10A803	234	11-267	137	11-636	226	11-890	160
09-516	87	09-752	90	10-920	83	10A822	234	11-270	158	11-640	223	11-891	160
09-517	84	09-753	90	10-922	83	10A824	234	11-299	133	11-690	152	11-892	160
09-518	87	09-754	90	10-924	83	10A827	234	11-300	128	11-691	152	11-893	160
09-520	88	09-760	90	10-926	83	10A840	234	11-301	128	11-700	162	11-901	153
09-523	85	09-761	90	10-928	83	10A842	234	11-302	128	11-701	162	11-902	153
09-524	87	09-762	90	10-940	83	10A843	234	11-303	128	11-702	162	11-903	153
09-525	85	09-763	90	10-942	83	10A844	234	11-304	128	11-705	162	11-904	153
09-526	87	09-764	90	10-944	83	10A846	234	11-305	129	11-710	164	11-905	153
09-530	84	09-765	90	10-946	83	10A848	234	11-306	128	11-711	164	11-906	153
09-531	84	09-766	90	10-948	83	10A903	372	11-307	129	11-712	164	11-907	153
09-532	84	09-767	90	10-960	83	10A905	372	11-310	129	11-714	163	11-908	153
09-533	84	09-768	90	10-970	83	10A906	372	11-311	130	11-716	164	11-909	153
09-534	84	09-769	90	10-972	83	10A907	372	11-312	129	11-718	164	11-915	153
09-535	84	09-770	90	10-978	83	10A915	372	11-313	129	11-719	164	11-920	152
09-536	84	09-771	90	10-980	83	10A916	372	11-314	130	11-720	163	11-922	152
09-537	84	09-791	90	10-982	83	10A917	372	11-315	130	11-730	161	11-925	152
09-538	84	09-806	93	10-988	83	11-020	37	11-316	130	11-731	161	11-931	153
09-539	84	09-808	93	10A035	229	11-021	37	11-317	130	11-732	161	11-950	155
09-540	84	09-810	93	10A055	229	11-022	37	11-320	130	11-735	162	11-952	155
09-541	84	09-812	93	10A065	233	11-023	37	11-321	131	11-750	162	11-953	155
09-542	84	09-814	93	10A115	230	11-024	37	11-322	131	11-751	162	11-956	155
09-543	84	09-816	93	10A130	230	11-030	154	11-323	131	11-760	162	11-960	155
09-544	84	09-817	93	10A135	230	11-100	146	11-324	131	11-761	162	11-961	155
09-545	84	09-818	93	10A145	230	11-101	146	11-325	131	11-762	162	11-963	156
09-546	84	09-819	93	10A150	230	11-102	146	11-326	131	11-763	162	11-970	156
09-550	87	09-820	93	10A160	230	11-111	146	11-330	132	11-796	148	11-971	156
09-551	87	09-821	93	10A212	233	11-112	146	11-331	132	11-797	148	11-972	156
09-552	87	09-824	93	10A214	233	11-113	146	11-332	132	11-798	148	11-973	157
09-553	87	09-825	93	10A216	233	11-122	144	11-333	132	11-799	149	11-974	157
09-554	87	09-830	93	10A225	230	11-123	144	11-334	133	11-801	149	11-975	157
09-555	87	09-851	93	10A230	230	11-125	144	11-335	132	11-802	149	11-976	158
09-556	87	09-852	93	10A235	230	11-126	144	11-336	132	11-803	149	11-977	157
09-557	87	09-860	93	10A310	233	11-127	144	11-337	133	11-804	149	11-978	157
09-558	87	09-890	297	10A330	233	11-128	144	11-338	129	11-805	148	11-979	156
09-559	87	09-906	95	10A332-72	233	11-129	144	11-360	140	11-806	148	11-980	156
09-570	73	09-908	95	10A333	233	11-130	145	11-361	140	11-807	148	11-981	157
09-571	85	09-910	95	10A335	233	11-131	145	11-362	140	11-808	148	11-983	158
09-573	87	09-912	95	10A336	233	11-132	145	11-363	140	11-810	151	11-984	159
09-605	97	09-914	95	10A337	233	11-135	145	11-364	140	11-811	151	11-985	159
09-607	97	09-916	95	10A337-72	233	11-152	147	11-365	140	11-812	151	11-986	159
09-608	98	09-918	95	10A338	233	11-153	147	11-366	140	11-813	151	11-991	161
09-609	97	09-920	95	10A339	233	11-165	147	11-367	140	11-816	148	11-992	161
09-615	98	09-921	95	10A440	228	11-167	137	11-368	140	11-817	151	11-993	161
09-706	90	09-924	95	10A441	228	11-168	137	11-369	140	11-819	158	11-997	159
09-707	90	09-930	95	10A442	228	11-169	137	11-370	140	11-822	155	11A145	257
09-708	90	09-952	95	10A445	228	11-170	135	11-371	140	11-823	155	11A230	257
09-709	90	09-980	95	10A446	228	11-171	135	11-372	140	11-824	155	11A314	257
09-710	90	09A106	241	10A447	228	11-190	147	11-373	140	11-825	155	11A406	252
09-711	90	09A108	241	10A450	228	11-191	147	11-380	141	11-827	150	11A409	252
09-712	90	09A110	241	10A451	228	11-192	147	11-381	141	11-832	160	11A411	252
09-713	90	09A112	241	10A452	228	11-203	134	11-382	141	11-834	159	11A413	252
09-714	90	09A114	241	10A453	228	11-204	134	11-383	140	11-836	159	12-070	175
09-715	90	09A115	241	10A504	228	11-205	134	11-384	140	11-847	149	12-071	175
09-716	90	09A116	241	10A505	228	11-218	135	11-400	154	11-848	151	12-072	175
09-717	90	09A118	241	10A506	228	11-221	136	11-401	154	11-850	150	12-074	175
09-718	90	09A120	241	10A540	228	11-222	136	11-402	154	11-851	150	12-075	175
09-719	90	09A122	241	10A545	228	11-223	136	11-403	154	11-852	150	12-076	175
09-720	90	09A125	241	10A550	228	11-224	136	11-404	154	11-857	150	12-079	175
09-721	90	09A132	241	10A640	228	11-226	136	11-500	143	11-858	150	12-080	175
09-722	90	09A138	241	10A645	228	11-227	136	11-510	142	11-859	150	12-081	175
09-723	90	09A310	241	10A650	228	11-228	136	11-511	142	11-861	150	12-101	174
09-724	90	09A320	242	10A703	231	11-231	141	11-512	166	11-862	150	12-102	174
09-725	90	09A322	242	10A706	231	11-235	140	11-532	143	11-865	150	12-105	174
09-727	90	09A410	241	10A710	231	11-237	141	11-550	142	11-866	150	12-107	174

Ref.	Str.	Ref.	Str.	Ref.	Str.	Ref.	Str.	Ref.	Str.	Ref.	Str.	Ref.	Str.
12-110	174	12A120	242	13A338	248	14-820	179	15-844	367	15G515	378	15G901	379
12-115	174	12A123	242	13A339	249	14A105	98	15-845	367	15G530	378	15G902	379
12-210	174	12A125	242	13A340	246	14A110	98	15-891	368	15G535	378	15G903	379
12-211	174	12A128	242	13A342	248	14A203	154	15A040	375	15G550	379	15G904	379
12-212	174	12A130	242	13A343	250	14A204	154	15A075	376	15G700	360	15G905	379
12-213	174	12A135	242	13A344	250	14A205	154	15G001	375	15G701	360	15G906	379
12-214	174	12A200	242	13A360	252	14A206	154	15G002	375	15G702	359	15G907	379
12-215	174	12A201	242	13A520	251	14A208	154	15G003	375	15G703	359	15G908	379
12-216	174	12A202	242	13A525	251	14A210	154	15G004	375	15G704	359	15G930	379
12-217	174	12A203	242	13A530	251	14A212	154	15G010	375	15G705	360	15G931	379
12-219	174	12A215	242	13A545	251	14A306	154	15G011	375	15G706	359	15G932	379
12-221	174	12A216	242	13A560	251	14A308	154	15G013	377	15G707	358	15G933	379
12-222	174	12A220	242	13A587	245	14A310	154	15G014	375	15G708	359	15G934	379
12-224	174	12A223	242	13A588	245	14A312	154	15G030	377	15G709	359	15G935	379
12-310	174	12A225	242	13A620	329	14A410	154	15G031	377	15G710	358	15G936	379
12-311	174	12A228	242	13A630	329	14A420	154	15G032	377	15G711	360	15G937	379
12-312	174	12A300	242	13A700	253	14A425	153	15G033	377	15G712	361	16-030	304
12-313	174	12A305	242	13A703	253	14A426	153	15G040	378	15G713	361	16-031	304
12-314	174	12A340	243	13A712	253	14A430	154	15G041	378	15G720	363	16-032	304
12-315	174	12A350	243	13A716	253	14A523	257	15G050	377	15G720-30	363	16-033	304
12-316	174	12A375	243	13A720	253	14A604	257	15G051	377	15G721	363	16-034	305
12-317	174	12A380	243	13A760	253	14A605	257	15G052	377	15G721-30	363	16-040	305
12-319	174	12A382	243	13A780	253	14A606	257	15G053	376	15G722	363	16-506	305
12-321	174	12A384	243	13A800	245	14A614	257	15G054	376	15G722-30	363	16-508	305
12-322	174	12A410	243	13A805	245	14A615	257	15G100	372	15G723	363	16-510	305
12-324	174	12A415	243	13A810	245	14A616	257	15G101	372	15G723-30	363	16-512	305
12-350	175	12A422	243	13A830	245	14A618	257	15G102	372	15G730	363	16-514	305
12-562	179	12A515	243	13A835	245	14A623	257	15G154	372	15G730-30	363	16B065	324
12-564	179	12A520	243	13A890	250	14A710	258	15G155	372	15G731	363	16B085	324
12-600	176	12A530	243	13A905	254	14A740	258	15G156	372	15G731-30	363	16B140	324
12-601	176	12A545	243	13A910	254	14A780	258	15G190	374	15G732	363	16B160	324
12-602	176	12A560	243	13A915	254	14A800	255	15G191	374	15G732-30	363	16B230	324
12-605	175	12A575	243	13A920	254	14A801	255	15G200	368	15G733	363	16B240	324
12-606	175	12A590	243	14-002	170	14A802	255	15G201	368	15G733-30	363	16B243	324
12-610	176	12K010	177	14-004	170	14A803	255	15G202	368	15G740	363	16B244	324
12-611	176	12K020	176	14-006	170	14A810	255	15G203	368	15G740-30	363	16B260	324
12-612	176	12K021	176	14-008	170	14A812	255	15G204	369	15G742	363	16B271	324
12-613	176	12K022	176	14-010	171	14A872	255	15G205	369	15G742-30	363	16B272	324
12-615	176	12K030	177	14-012	171	14A892	256	15G206	369	15G743	363	16B273	324
12-616	176	12K031	177	14-014	171	14A895	256	15G207	369	15G743-30	363	16B281	324
12-617	176	13 012	167	14-016	171	14A950	255	15G250	370	15G744	364	16B282	324
12-618	176	13 020	167	14-018	171	14A956	255	15G251	370	15G744-30	364	16B316	325
12-620	176	13 055	167	14-020	172	14A968	255	15G252	370	15G745	364	16B318	325
12-621	176	13-800	255	14-026	172	15 007	143	15G253	369	15G745-30	364	16B322	325
12-622	176	13-801	255	14-028	172	15 009	143	15G254	370	15G746	363	16B324	325
12-623	176	13-802	255	14-029	172	15 013	143	15G255	369	15G747	363	16B326	325
12-625	175	13-805	256	14-030	172	15 113-140	143	15G256	370	15G750	364	16B328	325
12-626	175	13-810	256	14-500	170	15-700	360	15G257	370	15G751	364	16B330	325
12-627	175	13-815	256	14-502	170	15-705	358	15G258	369	15G760	364	16B420	320
12-628	175	13-820	256	14-508	171	15-706	358	15G259	369	15G761	364	16B430	328
12 630	143	13-821	256	14-510	172	15-707	358	15G260	370	15G770	361	16B440	328
12-630	176	13-822	256	14-514	172	15-708	358	15G261	370	15G771	361	16B441	328
12 631	143	13-830	256	14-552	177	15-710	360	15G300	371	15G772	362	16B450	328
12-631	176	13-950	254	14-570	173	15-711	360	15G301	371	15G773	362	16B451	328
12 632	143	13-954	254	14-572	173	15-715	364	15G302	371	15G780	362	16B460	328
12-632	176	13-956	254	14-699	177	15-771	361	15G310	371	15G781	362	16B471	328
12-635	176	13-961	254	14-700	178	15-772	361	15G311	371	15G785	362	16B471-1	328
12-636	176	13-962	254	14-702	178	15-780	362	15G312	371	15G788	362	16B472	252
12 636-101	143	13-963	254	14-703	178	15-790	365	15G313	371	15G790	365	16B476	274
12-637	176	13-968	254	14-704	178	15-791	365	15G405	376	15G791	366	16B480	329
12-640	175	13A100	245	14-706	178	15-792	366	15G406	376	15G798	366	16B514	329
12-641	175	13A102	245	14-708	177	15-793	366	15G407	376	15G800	367	16B515	329
12 643	143	13A103	245	14-710	177	15-800	367	15G408	376	15G801	367	16B520	329
12-645	176	13A118	245	14-712	177	15-801	367	15G409	377	15G802	367	16B525	329
12-646	176	13A119	245	14-714	179	15-802	367	15G410	377	15G803	367	16B530	329
12-650	176	13A228	246	14-716	179	15-803	367	15G501	365	15G804	367	16B540	329
12-651	176	13A248	246	14-718	179	15-804	367	15G502	365	15G805	367	16B550	329
12-655	175	13A249	246	14-720	178	15-805	367	15G503	365	15G820	367	16B605	329
12 655-810	143	13A250	246	14-722	179	15-820	367	15G504	365	15G821	367	16B610	329
12-656	175	13A284	247	14-724	179	15-821	367	15G505	365	15G822	367	16B621	329
12 656-810	143	13A286	247	14-730	173	15-822	367	15G506	365	15G823	367	16B622	329
12 665-810	143	13A288	247	14-732	173	15-823	367	15G507	365	15G824	367	16B623	329
12 666-810	143	13A290	247	14-734	173	15-824	367	15G508	365	15G825	367	16B624	329
12 679	143	13A320	249	14-800	175	15-825	367	15G510	378	15G851	366	16B625	329
12 902	142	13A321	249	14-802	175	15-840	367	15G511	378	15G852	366	16B626	329
12 908	142	13A332	248	14-804	175	15-841	367	15G512	378	15G890	367	16B627	329
12A100	242	13A334	248	14-806	175	15-842	367	15G513	378	15G891	368	16B628	329
12A102	242	13A336	248	14-808	175	15-843	367	15G514	378	15G900	379	16B629	329

Ref.	Str.	Ref.	Str.	Ref.	Str.	Ref.	Str.	Ref.	Str.	Ref.	Str.	Ref.	Str.
17-080	306	19B620	259	23B175	261	27 030	167	29C506	268	31C902	271	32D512	38
17-082	306	19B625	259	23B203	331	27-030	373	29C507	268	32D030	30	32D513	38
17 786	166	19B630	259	23B204	331	27-031	373	29C572	268	32D031	32	32D517	39
17 793	167	19B640	259	23B205	331	27-032	373	29C601	268	32D032	31	32D518	39
17B2H5	323	20-011	310	23B222	331	27-033	373	29C602	268	32D033	31	32D530	35
17B103	319	20-012	310	23B224	331	27-050	374	29C603	268	32D034	33	32D531	35
17B109	319	20-021	312	23B257	302	27 070	167	29C604	268	32D036	31	32D541	35
17B118	318	20-022	312	23B258	302	27-120	373	29C605	268	32D098	27	32D543	33
17B128	318	20-025	312	23B259	302	27-121	373	29C606	268	32D099	27	32D721	30
17B140	320	20-030	313	24 110	142	27-123	373	29C607	268	32D100	27	32D723	31
17B160	320	20-130	312	24B108	331	27-124	373	29C871	269	32D101	28	32D724	32
17B168	319	20B525	260	24B111	331	27 622	167	29C872	269	32D103	28	32D725	32
17B172	320	20B526	260	24B113	331	27 632	167	29C873	269	32D106	29	32D726	31
17B191	318	20B540	260	24B115	331	27 846	168	29C882	268	32D107	29	32D755	33
17B328	319	20B542	260	24B120	331	27 846-950	168	29C883	268	32D108	30	32D806	42
17B348	323	20B551	260	24B121	332	27C001	265	29C884	268	32D109	30	32D810	41
17B349	323	20B555	260	24B122	332	27C123	265	29C893	268	32D110	27	32D855	36
17B405	323	20B557	260	24B125	331	27C124	265	29C894	268	32D111	27	32D856	36
17B428	319	20B587	261	24B150	332	27C233	265	29C897	269	32D112	27	32D857	36
17B490	318	20B594	260	25-010	224	27C235	265	29C902	269	32D113	28	33-060	238
17B518	319	20B597	260	25-012	224	27C302	265	29C908	269	32D114	28	33-061	238
17B528	319	20B640	261	25-013	224	27C303	265	29C909	269	32D115	28	33-062	238
17B528-12	319	20B641	261	25-014	224	27C305	265	30C217	274	32D116	28	33-063	238
17B531	319	20B642	261	25-015	224	27C308	265	30C320	275	32D118	29	33-064	238
17B533	319	20B650	261	25-018	224	27C310	265	30C321	276	32D119	29	33-066	238
17B548	323	20B667	261	25-020	224	27C313	265	30C326	275	32D120	30	33-067	238
17B550	323	20B671	261	25-025	224	27C315	265	30C330	275	32D121	30	33-068	238
17B632	320	20B801	330	25-030	224	27C318	265	30C333	275	32D122	27	33-069	238
17B639	320	20B806	261	25-052	225	27C340	265	30C335	275	32D123	27	33-072	237
17B656	320	20B816	260	25-053	225	27C342	265	30C343	276	32D124	27	33-073	237
17B658	320	20B817	260	25-054	225	27C343	265	30C345	276	32D125	28	33-074	237
17B703	332	20B945	261	25-061	225	27C345	265	30C347	276	32D126	29	33-081	237
17B714	332	20B966	259	25-062	225	27C383	265	30C363	275	32D127	29	33-082	237
17B716	332	20B968	259	25-063	225	27C385	265	30C364	275	32D130	35	33-083	237
17B721	332	20B969	259	25-064	225	27C387	265	30C365	275	32D131	35	33-084	237
17B722	332	21-001	315	25-067	225	28C412	266	30C614	273	32D137	33	34D010	36
17B723	332	21-002	315	25-068	225	28C413	266	30C615	273	32D138	29	34D020	36
17B900	231	21-003	315	25-071	226	28C450	266	30C616	255	32D139	35	34D031	50
18 071	166	21-004	315	25-072	226	28C512	266	30C617	255	32D141	35	34D032	50
18-101	307	21-011	316	25-073	226	28C513	266	30C630	273	32D143	33	34D033	50
18-102	308	21-012	316	25-083	224	28C533	266	30C643	272	32D160	32	34D034	50
18-103	307	21-013	316	25-085	224	28C534	266	31-018	234	32D161	31	34D035	97
18-106	307	21-014	316	25-088	224	28C550	266	31-019	234	32D162	33	34D036	50
18-107	308	21-015	316	25-090	224	28C551	266	31-024	234	32D163	31	34D037	50
18 417 051	168	21-016	316	25-101	220	29-030	239	31-025	234	32D164	30	34D038	50
18 766 950	168	21-017	316	25-102	220	29-040	239	31-030	234	32D165	32	34D052	50
18B204	251	21-018	316	25-103	221	29-041	239	31-035	234	32D166	31	34D052	50
18B206	251	21-019	316	25-104	221	29-061	239	31-050	235	32D301	34	34D052	50
18B208	251	21-020	316	25-105	221	29-091	239	31-055	235	32D302	34	34D053	50
18B210	251	21-021	316	25-106	221	29-092	239	31-060	235	32D304	34	34D053	50
18B212	251	21-022	316	25-107	223	29C113	268	31-061	235	32D306	34	34D055	50
18B215	251	21-023	316	25-131	220	29C114	268	31-062	235	32D307	34	34D056	50
18B218	251	21-024	316	25-132	221	29C122	268	31-063	235	32D308	34	34D065	51
18B303	251	21-025	316	25-133	222	29C123	268	31-065	235	32D309	34	34D067	51
18B304	251	21-026	316	25-143	224	29C124	268	31-070	236	32D320	34	34D070	51
18B305	251	21-027	316	25-144	224	29C125	268	31-075	236	32D401	29	34D082	51
18B306	251	21 127	142	25-145	224	29C142	269	31-080	236	32D402	44	34D110	48
18B308	251	21 127-950	142	25-146	224	29C143	269	31-081	235	32D404	44	34D111	48
18B310	251	21 163	165	25-147	224	29C144	269	31-082	235	32D405	41	34D112	48
18B312	251	21 165	165	25-148	224	29C145	269	31-083	235	32D406	42	34D120	49
18B330	251	21 167	165	25-149	224	29C152	269	31-084	235	32D407	29	34D121	49
18B436	252	21 169	165	25-151	224	29C153	269	31-085	235	32D408	44	34D122	49
18B437	252	21B131	326	25-152	224	29C154	269	31-086	235	32D409	44	34D130	48
18B526	328	21B132	326	25-153	224	29C155	269	31C030	274	32D410	44	34D131	48
18B527	328	21B235	326	25-154	224	29C301	268	31C050	274	32D413	332	34D132	48
18B550	328	21B245	326	25-155	224	29C302	268	31C075	274	32D420	310	34D204	48
18B604	251	21B330	325	25-157	224	29C303	268	31C100	274	32D421	37	34D301	51
18B605	251	21B330-1	325	25-161	223	29C304	268	31C615	273	32D422	310	34D305	51
18B606	251	21B336	326	25-162	223	29C305	268	31C616	273	32D423	46	34D308	51
18B607	251	21B360	325	26C005	264	29C401	268	31C621	273	32D424	37	34D512	36
18B610	251	21B438	326	26C006	264	29C402	268	31C625	273	32D425	46	34D513	36
18B612	251	21B501	327	26C011	264	29C403	268	31C627	273	32D450	36	34D612	48
19-901	313	21B503	327	26C012	264	29C404	268	31C628	273	32D455	36	34D613	48
19B116	259	21B504	327	27-006	373	29C501	268	31C629	273	32D456	36	34D614	48
19B117	259	21B507	327	27-008	373	29C502	268	31C700	276	32D458	37	34D615	48
19B118	259	21B509	327	27-010	373	29C503	268	31C701	272	32D459	37	34D616	48
19B610	259	21B510	327	27-012	373	29C504	268	31C703	272	32D510	38	34D654	48
19B615	259	23B145	261	27-019	373	29C505	268	31C800	272	32D511	38	34D701	48

Ref.	Str.	Ref.	Str.	Ref.	Str.	Ref.	Str.	Ref.	Str.	Ref.	Str.	Ref.	Str.
34D702	48	35D395	91	35D919	85	38D141	59	39-012	256	39D383	115	39D888	104
34D703	48	35D396	91	35D930	96	38D142	74	39-030	256	39D385	117	39D890	106
34D751	49	35D397	91	35D931	96	38D143	74	39-031	256	39D386	117	39D930	104
34D752	49	35D455	95	35D932	96	38D147	74	39-032	256	39D387	119	39D933	104
34D753	49	35D555	52	35D933	96	38D151	119	39-050	257	39D389	115	39D934	104
34D761	48	35D556	52	35D934	96	38D152	60	39-051	257	39D391	84	41-011	227
34D762	48	35D557	52	35D935	96	38D159	61	39-052	257	39D456	115	41-016	227
34D763	48	35D558	52	35D936	96	38D215	78	39-100	257	39D470	121	41-021	227
35-010	236	35D596	94	35D937	96	38D224	78	39D011	99	39D471	121	41-031	227
35-012	236	35D597	94	35D938	96	38D296	74	39D012	99	39D472	121	41-036	227
35-015	236	35D605	93	35D939	96	38D300	97	39D016	99	39D473	121	41-041	227
35D030	96	35D607	93	35D940	96	38D500	79	39D017	99	39D474	121	41-061	227
35D031	96	35D609	93	35D941	96	38D501	58	39D018	99	39D475	121	41-066	227
35D032	96	35D611	93	35D950	88	38D502	58	39D019	100	39D476	121	41-091	232
35D035	96	35D613	93	35D951	88	38D505	74	39D054	126	39D477	121	41-096	231
35D036	96	35D615	93	35D952	88	38D510	79	39D055	126	39D479	121	41-111	227
35D051	86	35D619	93	35D954	85	38D515	76	39D058	126	39D480	121	41-116	227
35D055	86	35D623	93	35D955	86	38D520	75	39D066	126	39D503	105	41-131	227
35D112	53	35D630	94	35D956	86	38D521	58	39D067	126	39D504	101	41-136	227
35D113	53	35D632	94	35D957	86	38D522	58	39D081	160	39D506	101	41-141	227
35D114	53	35D633	94	35D958	86	38D525	75	39D082	160	39D516	105	41-161	228
35D115	53	35D635	94	35D959	88	38D530	75	39D104	101	39D518	114	41-166	228
35D117	53	35D636	94	35D960	88	38D535	79	39D105	105	39D522	116	41-201	232
35D118	53	35D655	93	35D961	88	38D540	58	39D106	105	39D551	107	41-226	231
35D119	53	35D656	93	35D962	86	38D541	58	39D107	105	39D552	107	41E006	305
35D120	53	35D657	93	35D963	86	38D542	59	39D122	112	39D555	109	41E008	305
35D121	52	35D700	52	35D964	88	38D543	59	39D150	122	39D556	120	41E010	305
35D122	52	35D701	91	35D966	85	38D545	79	39D155	122	39D558	108	41E012	305
35D123	52	35D702	91	35D967	86	38D550	75	39D173	120	39D559	108	41E014	305
35D124	52	35D703	91	35D968	88	38D552	60	39D174	104	39D640	98	41E306	305
35D154	52	35D705	91	35D969	87	38D553	61	39D177	105	39D641	98	41E308	305
35D156	52	35D707	91	37-022	239	38D554	61	39D179	104	39D642	98	41E310	305
35D162	96	35D708	91	37-122	239	38D555	60	39D180	115	39D643	98	41E312	305
35D164	96	35D709	91	37-222	239	38D556	60	39D181	115	39D644	98	41E314	305
35D166	96	35D710	91	37-322	239	38D557	59	39D183	112	39D645	98	41E406	305
35D167	96	35D711	91	37-422	239	38D558	59	39D185	117	39D650	99	41E408	305
35D168	96	35D712	91	37-540	241	38D570	76	39D193	108	39D651	99	41E410	305
35D169	96	35D713	91	37-545	241	38D640	73	39D194	108	39D652	99	41E412	305
35D171	96	35D714	91	37-550	241	38D642	74	39D197	109	39D653	99	41E414	305
35D173	96	35D716	91	37-600	241	38D650	73	39D200	117	39D655	100	41E901	305
35D176	96	35D718	91	37-605	239	38D652	73	39D250	100	39D656	100	41E903	304
35D177	96	35D721	91	37-610	239	38D669	73	39D251	100	39D673	122	41E904	305
35D179	96	35D723	91	37D051	147	38D710	55	39D252	100	39D674	123	41E905	304
35D180	96	35D725	91	37D052	147	38D712	55	39D253	100	39D771	107	41E906	304
35D181	96	35D740	92	37D105	89	38D713	55	39D254	100	39D772	107	41E908	304
35D191	96	35D741	92	37D109	89	38D714	55	39D255	100	39D773	107	41E915	305
35D193	96	35D743	92	37D110	89	38D715	55	39D256	100	39D774	107	42E081	307
35D240	97	35D744	92	37D204	141	38D716	55	39D260	101	39D801	98	42E110	307
35D242	97	35D745	92	37D205	141	38D717	55	39D261	101	39D802	98	42E113	307
35D246	97	35D746	92	37D207	141	38D718	55	39D263	101	39D803	98	42E151	307
35D247	97	35D747	92	37D221	147	38D719	55	39D264	101	39D804	98	42E152	307
35D251	97	35D748	92	37D222	147	38D721	55	39D314	119	39D805	98	42E154	307
35D255	94	35D749	92	37D305	146	38D722	55	39D337	118	39D806	98	42E155	307
35D256	94	35D750	92	37D310	146	38D724	55	39D338	118	39D807	98	42E171	307
35D257	94	35D755	91	37D313	146	38D727	55	39D339	118	39D808	98	42E172	307
35D355	92	35D756	91	37D405	150	38D730	55	39D340	118	39D820	99	42E173	307
35D356	92	35D757	91	37D406	150	38D732	55	39D341	118	39D821	99	42E180	307
35D357	92	35D758	91	37D410	149	38D751	55	39D342	82	39D822	99	42E181	307
35D359	92	35D807	95	37D501	154	38D753	55	39D343	109	39D823	99	42E182	307
35D360	92	35D809	95	37D502	154	38D755	55	39D344	116	39D824	99	42E500	306
35D370	92	35D811	95	37D503	154	38D756	55	39D346	116	39D825	99	42E501	306
35D374	91	35D813	95	37D504	154	38D757	55	39D350	114	39D829	100	42E521	306
35D375	91	35D815	95	37D505	154	38D760	55	39D351	114	39D830	100	42E522	306
35D380	91	35D817	95	37D506	154	38D761	55	39D352	117	39D831	100	42E580	306
35D381	91	35D821	95	37D507	154	38D762	55	39D355	115	39D832	100	42E581	306
35D382	91	35D823	95	37D508	154	38D763	55	39D356	116	39D833	100	43-300	229
35D383	91	35D855	95	37D509	154	38D764	147	39D357	117	39D840	100	43-301	229
35D384	91	35D856	95	37D510	154	38D765	147	39D358	115	39D842	100	43-302	229
35D385	91	35D904	85	37D511	154	38D804	82	39D359	114	39D843	100	43-310	229
35D386	91	35D905	85	37D512	154	38D805	82	39D361	116	39D844	100	43-320	233
35D387	91	35D906	85	37D513	154	38D806	82	39D363	114	39D845	100	43E100	309
35D388	91	35D907	85	37D514	154	38D807	82	39D369	117	39D846	100	43E101	309
35D389	91	35D908	85	37D515	154	38D808	82	39D375	82	39D860	118	43E111	309
35D390	91	35D910	85	37D516	154	38D809	82	39D377	84	39D865	112	43E133	309
35D391	91	35D912	85	37D517	154	38D810	82	39D378	82	39D884	103	43E134	309
35D392	91	35D913	85	37D518	154	38D850	74	39D379	82	39D885	103	43E135	309
35D393	91	35D914	85	38D101	59	39-010	256	39D381	115	39D886	104	43E136	309
35D394	91	35D917	85	38D121	59	39-011	256	39D382	119	39D887	106	43E301	309

Ref.	Str.	Ref.	Str.	Ref.	Str.	Ref.	Str.	Ref.	Str.	Ref.	Str.	Ref.	Str.
43E302	309	44E971	316	50-204	247	56-801	258	67-112	264	75-000	273	79R365	302
43E401	309	44E972	316	50-205	247	56-802	258	67-113	264	75-001	273	79R367	302
43E402	309	44E973	316	50-209	246	56-803	258	67-115	264	75-011	273	79R401	295
43E403	309	44E974	316	50-221	248	56-820	258	67-183	264	75-100	270	79R402	295
43E404	309	44E975	316	50-222	248	56-821	258	67-185	264	75-101	270	79R405	295
43E405	309	44E976	316	50-223	248	61-001	325	67-188	264	75-102	270	79R410	295
43E421	309	44E977	316	50-224	247	61-002	325	67-193	264	75-103	270	79R415	296
43E501	309	44E978	316	50-225	247	61-003	325	67-195	264	75-104	270	79R416	296
43E502	309	44E979	316	50-226	247	61-004	325	67-198	264	75-106	270	79R420	295
43E503	309	44E980	316	50-227	248	61-005	325	67-203	264	75-107	270	79R421	296
43E504	309	44E981	316	50-231	249	61-006	325	67-205	264	75-108	271	79R430	296
43E505	309	44E982	316	50-232	249	61-011	326	67-208	264	75-109	270	79R431	296
43E507	309	44E983	316	50-241	249	61-012	326	67-213	264	75-110	271	79R432	296
43E509	309	44E984	316	50-242	249	61-013	327	67-215	264	75-113	271	79R440	293
43E701	308	45-220	242	50-251	252	61-014	327	67-218	264	75-115	271	79R441	293
43E703	308	45-230	242	50-252	250	61-100	329	68-030	266	75-120	272	79R444	293
43E707	308	45-240	242	50-253	249	61-101	329	68-050	266	75-121	272	79R447	294
43E712	308	45-450	242	50-261	249	61-102	329	68-120	266	75-130	272	79R449	294
43E713	308	45-451	242	50-262	249	61-103	329	68-130	266	75-131	272	79R500	283
43E780	308	45-452	242	50-281	250	61-104	329	68-150	266	75-201	271	79R501	283
43E790	309	45-453	242	50-282	250	63-011	318	71-000	267	75-202	271	79R502	283
43E791	309	45-454	242	50-283	250	63-012	318	71-001	267	75-203	271	79R510	284
44-600	229	45-455	242	50-291	247	63-021	318	71-030	267	75-270	272	79R511	284
44-618	233	45-456	242	50-292	247	63-025	345	71-061	267	77P505	166	79R512	284
44E000	314	45-457	242	50-293	247	63-026	345	71-062	267	77P530	142	79R513	284
44E002	314	49-905	254	50-294	247	63-027	346	71-063	267	79R100	290	79R514	284
44E003	314	49-910	254	50-295	247	63-050	318	71-064	267	79R101	290	79R515	284
44E004	314	49-915	254	50-304	251	63-060	318	71-065	267	79R102	290	79R516	285
44E005	314	49-920	254	50-305	251	63-105	344	71-066	267	79R120	290	79R517	285
44E006	314	49-931	254	50-306	251	63-106	344	71-067	267	79R121	290	79R518	285
44E007	314	50-101	244	50-351	251	63-107	345	71-081	267	79R122	290	80-220-L	181
44E024	313	50-102	244	50-352	251	63-108	346	71-082	267	79R123	290	80-220-M	181
44E026	313	50-105	244	50-353	251	63-109	346	71-083	267	79R124	290	80-220-S	181
44E029	313	50-111	244	50-354	251	63-110	345	71-084	267	79R125	290	80-220-XXL	181
44E030	313	50-112	244	50-355	251	63-111	345	71-085	267	79R129	290	80-220-XXL	181
44E031	313	50-113	244	50-356	251	63-112	344	71-086	267	79R131	290	80-240-L	181
44E106	313	50-121	244	50-357	251	63-113	344	71-087	267	79R132	290	80-240-M	181
44E108	313	50-122	244	50-358	251	63-114	345	71-092	267	79R133	290	80-240-S	181
44E110	310	50-123	244	50-359	251	63-115	345	71-093	267	79R160	291	80-240-XXL	181
44E111	310	50-131	244	50-360	251	63-116	345	71-094	267	79R163	291	80-240-XXL	181
44E115	310	50-132	244	50-500	250	63-117	346	71-095	267	79R167	298	80-500-L	193
44E117	311	50-133	244	50-501	250	63-118	347	71-096	267	79R168	298	80-500-M	193
44E118	311	50-134	244	50-502	250	63-119	347	71-097	267	79R169	298	80-500-S	193
44E120	310	50-136	244	50-503	250	63-120	346	71-102	267	79R170	298	80-500-XL	193
44E121	311	50-137	244	50-504	250	63-121	347	71-103	267	79R171	298	80-500-XXL	193
44E122	311	50-138	244	50-530	250	63-122	347	71-104	267	79R172	298	80-501-L	193
44E123	311	50-139	244	50-550	250	63-123	343	71-105	267	79R173	298	80-501-M	193
44E139	312	50-141	244	50-551	250	63-124	343	71-106	267	79R174	291	80-501-S	193
44E140	312	50-142	244	50-552	250	63-125	342	71-112	267	79R175	291	80-501-XL	193
44E141	312	50-143	244	50-553	250	63-126	343	71-113	267	79R176	291	80-501-XXL	193
44E142	313	50-146	244	50-554	250	63-128	343	71-114	267	79R177	291	80-550-L	196
44E143	312	50-147	244	51G510	356	63-130	343	71-116	267	79R178	291	80-550-M	196
44E148	313	50-148	244	56-004	324	63-131	348	71-200	267	79R182	298	80-550-S	196
44E150	313	50-151	244	56-005	324	63-132	343	72-021	274	79R183	298	80-550-XL	196
44E152	312	50-152	244	56-006	325	63-133	342	72-022	274	79R184	298	80-550-XXL	196
44E154	313	50-155	244	56-007	323	63-134	342	72-023	274	79R186	298	80-555-L	194
44E155	312	50-156	244	56-008	323	63-135	342	72-024	274	79R187	258	80-555-M	194
44E160	316	50-160	246	56-020	330	63-138	342	72-025	274	79R200	293	80-555-S	194
44E512	314	50-161	246	56-021	330	63-139	342	72-031	274	79R204	293	80-555-XXL	194
44E514	314	50-162	247	56-022	330	63-140	342	72-032	274	79R220	290	80-555-XXL	194
44E517	314	50-163	247	56-023	330	63-141	342	72-033	274	79R255	294	80-610-L	200
44E519	314	50-164	247	56-024	330	63-701	320	72-034	274	79R273	301	80-610-M	200
44E522	314	50-166	246	56-025	330	63-702	319	72-035	274	79R274	301	80-610-S	200
44E524	314	50-167	247	56-026	330	63-710	320	72-102	275	79R275	301	80-610-XXL	200
44E532	314	50-168	247	56-027	330	63-901	236	72-105	275	79R290	356	80-610-XXL	200
44E731	315	50-169	247	56-028	330	64-010	322	72-109	275	79R300	300	80-611-L	200
44E732	315	50-171	246	56-029	330	64-012	322	72-115	275	79R301	300	80-611-M	200
44E742	314	50-172	247	56-030	331	64-013	322	72-120	275	79R302	300	80-611-S	200
44E745	315	50-173	247	56-031	331	64-014	322	72-125	275	79R305	300	80-611-XXL	200
44E812	314	50-174	247	56-032	331	64-015	323	72-126	275	79R306	300	80-611-XXL	200
44E816	314	50-181	246	56-033	331	64-020	322	72-127	275	79R319	297	81-110-L	192
44E950	316	50-182	247	56-034	331	64-210	322	72-200	274	79R351	302	81-110-LD	192
44E952	316	50-183	247	56-035	331	64-220	323	72-205	274	79R352	302	81-110-M	192
44E954	316	50-191	246	56-036	331	64-410	323	72-300	276	79R355	302	81-110-S	192
44E956	316	50-196	246	56-037	331	64-420	323	72-350	274	79R356	302	81-110-XL	192
44E958	316	50-201	246	56-039	332	64-610	323	72-351	274	79R357	302	81-110-XXL	192
44E960	316	50-202	247	56-040	331	64-620	323	74-010	264	79R363	302	81-120-L	183
44E970	316	50-203	247	56-800	258	67-111	264	74-020	264	79R364	302	81-120-LD	183

Ref.	Str.	Ref.	Str.	Ref.	Str.	Ref.	Str.	Ref.	Str.	Ref.	Str.	Ref.	Str.
81-120-M	183	81-223-XXXL	182	81-241-XS	182	81-270-XL	189	81-410-S	192	81-533-M	202	81-561-M	199
81-120-S	183	81-224-L	183	81-241-XXL	182	81-270-XXL	189	81-410-XL	192	81-533-S	202	81-561-S	199
81-120-XL	183	81-224-M	183	81-241-XXXL	182	81-271-L	189	81-410-XXL	192	81-533-XL	202	81-561-XL	199
81-120-XXL	183	81-224-S	183	81-242-L	182	81-271-M	189	81-420-L	184	81-533-XXL	202	81-561-XXL	199
81-140-L	183	81-224-XL	183	81-242-M	182	81-271-S	189	81-420-LD	184	81-534-L	202	81-561-XXXL	199
81-140-LD	183	81-224-XS	183	81-242-S	182	81-271-XL	189	81-420-M	184	81-534-M	202	81-565-L	186
81-140-M	183	81-224-XXL	183	81-242-XL	182	81-271-XS	189	81-420-S	184	81-534-S	202	81-565-M	186
81-140-S	183	81-224-XXXL	183	81-242-XS	182	81-271-XXL	189	81-420-XL	184	81-534-XL	202	81-565-S	186
81-140-XL	183	81-225-L	183	81-242-XXL	182	81-271-XXXL	189	81-420-XXL	184	81-534-XXL	202	81-565-XL	186
81-140-XXL	183	81-225-M	183	81-242-XXXL	182	81-276-L	189	81-430-L	184	81-534-XXXL	202	81-565-XXL	186
81-210-L	192	81-225-S	183	81-243-L	182	81-276-M	189	81-430-LD	184	81-540-L	203	81-565-XXXL	186
81-210-LD	192	81-225-XL	183	81-243-M	182	81-276-S	189	81-430-M	184	81-540-M	203	81-566-L	186
81-210-M	192	81-225-XXL	183	81-243-S	182	81-276-XL	189	81-430-S	184	81-540-S	203	81-566-M	186
81-210-S	192	81-226-L	181	81-243-XL	182	81-276-XS	189	81-430-XL	184	81-540-XL	203	81-566-S	186
81-210-XL	192	81-226-M	181	81-243-XS	182	81-276-XXL	189	81-430-XXL	184	81-540-XXL	203	81-566-XL	186
81-210-XXL	192	81-226-S	181	81-243-XXL	182	81-276-XXXL	189	81-440-L	190	81-541-L	203	81-566-XXL	186
81-211-L	191	81-226-XL	181	81-243-XXXL	182	81-278-L	189	81-440-LD	190	81-541-M	203	81-566-XXXL	186
81-211-M	191	81-226-XS	181	81-244-L	183	81-278-M	189	81-440-M	190	81-541-S	203	81-570-L	197
81-211-S	191	81-226-XXL	181	81-244-M	183	81-278-S	189	81-440-S	190	81-541-XL	203	81-570-M	197
81-211-XL	191	81-226-XXXL	181	81-244-S	183	81-278-XL	189	81-440-XL	190	81-541-XXL	203	81-570-S	197
81-211-XXL	191	81-227-L	181	81-244-XL	183	81-278-XS	189	81-440-XXL	190	81-549-L	203	81-570-XL	197
81-211-XXXL	191	81-227-M	181	81-244-XS	183	81-278-XXL	189	81-500-L	193	81-549-M	203	81-570-XXL	197
81-213-L	191	81-227-S	181	81-244-XXL	183	81-278-XXXL	189	81-500-M	193	81-549-S	203	81-571-L	197
81-213-M	191	81-227-XL	181	81-244-XXXL	183	81-279-L	189	81-500-S	193	81-549-XL	203	81-571-M	197
81-213-S	191	81-227-XS	181	81-245-L	183	81-279-M	189	81-500-XL	193	81-549-XXL	203	81-571-S	197
81-213-XL	191	81-227-XXL	181	81-245-M	183	81-279-S	189	81-500-XXL	193	81-549-XXXL	203	81-571-XL	197
81-213-XXL	191	81-227-XXXL	181	81-245-S	183	81-279-XL	189	81-501-L	193	81-550-L	196	81-571-XXL	197
81-213-XXXL	191	81-228-L	186	81-245-XL	183	81-279-XS	189	81-501-M	193	81-550-M	196	81-571-XXXL	197
81-215-L	191	81-228-M	186	81-245-XXL	183	81-279-XXL	189	81-501-S	193	81-550-S	196	81-572-L	197
81-215-M	191	81-228-S	186	81-246-L	181	81-279-XXXL	189	81-501-XL	193	81-550-XL	196	81-572-M	197
81-215-S	191	81-228-XL	186	81-246-M	181	81-310-L	192	81-501-XXL	193	81-550-XXL	196	81-572-S	197
81-215-XL	191	81-228-XS	186	81-246-S	181	81-310-LD	192	81-505-L	193	81-551-L	196	81-572-XL	197
81-215-XXL	191	81-228-XXL	186	81-246-XL	181	81-310-M	192	81-505-M	193	81-551-M	196	81-572-XXL	197
81-216-L	191	81-228-XXXL	186	81-246-XS	181	81-310-S	192	81-505-S	193	81-551-S	196	81-572-XXXL	197
81-216-M	191	81-229-L	186	81-246-XXL	181	81-310-XL	192	81-505-XL	193	81-551-XL	196	81-573-L	197
81-216-S	191	81-229-M	186	81-246-XXXL	181	81-310-XXL	192	81-505-XXL	193	81-551-XXL	196	81-573-M	197
81-216-XL	191	81-229-S	186	81-247-L	181	81-311-L	192	81-506-L	193	81-551-XXXL	196	81-573-S	197
81-216-XXL	191	81-229-XL	186	81-247-M	181	81-311-M	192	81-506-M	193	81-553-L	196	81-573-XL	197
81-216-XXXL	191	81-229-XS	186	81-247-S	181	81-311-S	192	81-506-S	193	81-553-M	196	81-573-XXL	197
81-217-L	191	81-229-XXL	186	81-247-XL	181	81-311-XL	192	81-506-XL	193	81-553-S	196	81-573-XXXL	197
81-217-M	191	81-229-XXXL	186	81-247-XS	181	81-311-XXL	192	81-506-XXL	193	81-553-XL	196	81-574-L	197
81-217-S	191	81-230-L	185	81-247-XXL	181	81-311-XXXL	192	81-506-XXXL	193	81-553-XXL	196	81-574-M	197
81-217-XL	191	81-230-LD	185	81-247-XXXL	181	81-320-L	185	81-511-L	194	81-554-L	197	81-574-S	197
81-217-XS	191	81-230-M	185	81-248-L	184	81-320-LD	185	81-511-M	194	81-554-M	197	81-574-XL	197
81-217-XXL	191	81-230-S	185	81-248-M	184	81-320-M	185	81-511-S	194	81-554-S	197	81-574-XXL	197
81-217-XXXL	191	81-230-XL	185	81-248-S	184	81-320-S	185	81-511-XL	194	81-554-XL	197	81-574-XXXL	197
81-218-L	192	81-230-XXL	185	81-248-XL	184	81-320-XXL	185	81-511-XXL	194	81-554-XXL	197	81-575-L	198
81-218-M	192	81-231-L	184	81-248-XS	184	81-320-XXL	185	81-511-XXXL	194	81-554-XXXL	197	81-575-M	198
81-218-S	192	81-231-M	184	81-248-XXL	184	81-321-L	185	81-512-L	194	81-555-L	194	81-575-S	198
81-218-XL	192	81-231-S	184	81-248-XXXL	184	81-321-M	185	81-512-M	194	81-555-M	194	81-575-XL	198
81-218-XXL	192	81-231-XL	184	81-250-L	186	81-321-S	185	81-512-S	194	81-555-S	194	81-575-XXL	198
81-218-XXXL	192	81-231-XS	184	81-250-LD	186	81-321-XL	185	81-512-XL	194	81-555-XL	194	81-575-XXXL	198
81-220-L	185	81-231-XXL	184	81-250-M	186	81-321-XS	185	81-512-XXL	194	81-555-XXL	194	81-602-L	200
81-220-LD	185	81-231-XXXL	184	81-250-S	186	81-321-XXL	185	81-512-XXXL	194	81-555-XXXL	194	81-602-M	200
81-220-M	185	81-238-L	184	81-250-XL	186	81-321-XXXL	185	81-520-L	202	81-556-L	194	81-602-S	200
81-220-S	185	81-238-M	184	81-250-XXL	186	81-325-L	185	81-520-M	202	81-556-M	194	81-602-XXL	200
81-220-XL	185	81-238-S	184	81-258-L	186	81-325-M	185	81-520-S	202	81-556-S	194	81-602-XXL	200
81-220-XXL	185	81-238-XL	184	81-258-M	186	81-325-S	185	81-520-XL	202	81-556-XL	194	81-602-XXXL	200
81-221-L	182	81-238-XS	184	81-258-S	186	81-325-XL	185	81-520-XXL	202	81-556-XXL	194	81-603-L	200
81-221-M	182	81-238-XXL	184	81-258-XL	186	81-325-XS	185	81-520-XXXL	202	81-556-XXXL	194	81-603-M	200
81-221-S	182	81-238-XXXL	184	81-258-XS	186	81-325-XXL	185	81-521-L	202	81-557-L	198	81-603-S	200
81-221-XL	182	81-239-L	184	81-258-XXL	186	81-325-XXXL	185	81-521-M	202	81-557-M	198	81-603-XL	200
81-221-XS	182	81-239-M	184	81-258-XXXL	186	81-330-L	190	81-521-S	202	81-557-S	198	81-603-XXL	200
81-221-XXL	182	81-239-S	184	81-260-L	203	81-330-LD	190	81-521-XL	202	81-557-XL	198	81-603-XXXL	200
81-221-XXXL	182	81-239-XL	184	81-260-M	203	81-330-M	190	81-521-XXL	202	81-557-XXL	198	81-603-XXXL	200
81-222-L	182	81-239-XS	184	81-260-S	203	81-330-S	190	81-521-XXXL	202	81-557-XXXL	198	81-606-L	201
81-222-M	182	81-239-XXL	184	81-260-XL	203	81-330-XL	190	81-530-L	202	81-558-L	196	81-606-M	201
81-222-S	182	81-239-XXXL	184	81-260-XXL	203	81-330-XXL	190	81-530-M	202	81-558-M	196	81-606-S	201
81-222-XL	182	81-240-L	185	81-268-L	203	81-331-L	190	81-530-S	202	81-558-S	196	81-606-XL	201
81-222-XS	182	81-240-LD	185	81-268-M	203	81-331-M	190	81-530-XL	202	81-558-XL	196	81-606-XXL	201
81-222-XXL	182	81-240-M	185	81-268-S	203	81-331-S	190	81-530-XXL	202	81-558-XXL	196	81-606-XXXL	201
81-222-XXXL	182	81-240-S	185	81-268-XL	203	81-331-XL	190	81-532-L	202	81-559-L	196	81-610-L	199
81-223-L	182	81-240-XL	185	81-268-XXL	203	81-331-XS	190	81-532-M	202	81-559-M	196	81-610-M	199
81-223-M	182	81-240-XXL	185	81-268-XXXL	203	81-331-XXL	190	81-532-S	202	81-559-S	196	81-610-S	199
81-223-S	182	81-241-L	182	81-270-L	189	81-331-XXXL	190	81-532-XL	202	81-559-XL	196	81-610-XL	199
81-223-XL	182	81-241-M	182	81-270-LD	189	81-410-L	192	81-532-XXL	202	81-559-XXL	196	81-610-XXL	199
81-223-XS	182	81-241-S	182	81-270-M	189	81-410-LD	192	81-532-XXXL	202	81-559-XXXL	196	81-611-L	199
81-223-XXL	182	81-241-XL	182	81-270-S	189	81-410-M	192	81-533-L	202	81-561-L	199	81-611-M	199

Ref.	Str.	Ref.	Str.	Ref.	Str.	Ref.	Str.	Ref.	Str.	Ref.	Str.	Ref.	Str.	Ref.	Str.
81-611-S	199	81-700-XL	195	81-746-XXL	195	81-783-M	191	82-080-37	209	82-151-45	208	82-705	210		
81-611-XL	199	81-700-XXL	195	81-750-L	187	81-783-S	191	82-080-38	209	82-151-46	208	82-706	210		
81-611-XXL	199	81-700-XXXL	195	81-750-M	187	81-783-XL	191	82-080-39	209	82-151-47	208	82-707	210		
81-612-L	200	81-701-L	195	81-750-S	187	81-783-XXL	191	82-080-40	209	82-155-39	207	82-708	210		
81-612-M	200	81-701-M	195	81-750-XL	187	81-792-L	187	82-080-41	209	82-155-40	207	82-710	210		
81-612-S	200	81-701-S	195	81-750-XXL	187	81-792-M	187	82-080-42	209	82-155-41	207	82-711	210		
81-612-XL	200	81-701-XL	195	81-750-XXXL	187	81-792-S	187	82-080-43	209	82-155-42	207	82-712	210		
81-612-XXL	200	81-701-XXL	195	81-751-L	187	81-792-XL	187	82-080-44	209	82-155-43	207	82-713	210		
81-613-L	200	81-701-XXXL	195	81-751-M	187	81-792-XXL	187	82-080-45	209	82-155-44	207	82-714	210		
81-613-M	200	81-710-L	198	81-751-S	187	81-792-XXXL	187	82-080-46	209	82-155-45	207	82-715	210		
81-613-S	200	81-710-M	198	81-751-XL	187	81-793	205	82-080-47	209	82-155-46	207	82-716	210		
81-613-XL	200	81-710-S	198	81-751-XXL	187	81-794	205	82-090	207	82-155-47	207	82-717	210		
81-613-XXL	200	81-710-XL	198	81-751-XXXL	187	81-800-L	199	82-091	207	82-156-36	207	82-718	210		
81-614-L	200	81-710-XXL	198	81-760-L	187	81-800-M	199	82-092	207	82-156-37	207	82-720	210		
81-614-M	200	81-710-XXXL	198	81-760-M	187	81-800-XL	199	82-093	207	82-156-38	207	82-721	210		
81-614-S	200	81-711-L	198	81-760-S	187	81-800-XXL	199	82-094	207	82-156-39	207	82-722	210		
81-614-XL	200	81-711-M	198	81-760-XL	187	81-800-XXXL	199	82-095	207	82-156-40	207	82-723	210		
81-614-XXL	200	81-711-S	198	81-760-XXL	187	81-810-L	199	82-096	207	82-156-41	207	82-724	210		
81-614-XXXL	200	81-711-XL	198	81-760-XXXL	187	81-810-M	199	82-097	207	82-156-42	207	82-725	210		
81-615-L	200	81-711-XXL	198	81-761-L	188	81-810-XL	199	82-098	207	82-156-43	207	82-726	210		
81-615-M	200	81-711-XXXL	198	81-761-M	188	81-810-XXL	199	82-100	208	82-156-44	207	82-727	210		
81-615-S	200	81-720-L	198	81-761-S	188	81-810-XXXL	199	82-101	208	82-156-45	207	82-728	210		
81-615-XL	200	81-720-M	198	81-761-XL	188	81-811-L	187	82-102	208	82-156-46	207	82-730	210		
81-615-XXL	200	81-720-S	198	81-761-XXL	188	81-811-M	187	82-103	208	82-156-47	207	82-731	210		
81-616-L	202	81-720-XL	198	81-761-XXXL	188	81-811-XL	187	82-104	208	82-157-39	207	82-732	210		
81-616-M	202	81-720-XXL	198	81-770-L	188	81-811-XXL	187	82-105	208	82-157-40	207	82-733	210		
81-616-S	202	81-720-XXXL	198	81-770-M	188	81-811-XXXL	187	82-106	208	82-157-41	207	82-734	210		
81-616-XL	202	81-721-L	198	81-770-S	188	81-900	215	82-107	208	82-157-42	207	82-735	210		
81-616-XXL	202	81-721-M	198	81-770-XL	188	81-901	215	82-108	208	82-157-43	207	82-736	210		
81-617-L	202	81-721-S	198	81-770-XXL	188	82-010	207	82-110	208	82-157-44	207	82-737	210		
81-617-M	202	81-721-XL	198	81-770-XXXL	188	82-011	207	82-111	208	82-157-45	207	82-738	210		
81-617-S	202	81-721-XXL	198	81-771-L	188	82-012	207	82-112	208	82-157-46	207	82-740-39	209		
81-617-XL	202	81-721-XXXL	198	81-771-M	188	82-013	207	82-113	208	82-157-47	207	82-740-40	209		
81-617-XXL	202	81-730-L	201	81-771-S	188	82-014	207	82-114	208	82-300	211	82-740-41	209		
81-619-L	201	81-730-M	201	81-771-XL	188	82-015	207	82-115	208	82-301	211	82-740-42	209		
81-619-M	201	81-730-S	201	81-771-XXL	188	82-016	207	82-116	208	82-302	211	82-740-43	209		
81-619-S	201	81-730-XL	201	81-771-XXXL	188	82-017	207	82-117	208	82-303	211	82-740-44	209		
81-619-XL	201	81-730-XXL	201	81-775-L	188	82-018	207	82-118	208	82-310	211	82-740-45	209		
81-619-XXL	201	81-731-L	201	81-775-M	188	82-020	208	82-120	208	82-311	211	82-740-46	209		
81-619-XXXL	201	81-731-M	201	81-775-S	188	82-021	208	82-121	208	82-312	211	82-740-47	209		
81-620	205	81-731-S	201	81-775-XL	188	82-022	208	82-122	208	82-313	211	82-750-39	210		
81-621	205	81-731-XL	201	81-775-XXL	188	82-023	208	82-123	208	82-314	211	82-750-40	210		
81-622	205	81-731-XXL	201	81-776-L	188	82-024	208	82-124	208	82-320	211	82-750-41	210		
81-623	205	81-732-L	201	81-776-M	188	82-025	208	82-125	208	82-321	211	82-750-42	210		
81-624	205	81-732-M	201	81-776-S	188	82-026	208	82-126	208	82-322	211	82-750-43	210		
81-625	205	81-732-S	201	81-776-XL	188	82-027	208	82-127	208	82-323	211	82-750-44	210		
81-626	205	81-732-XXL	201	81-776-XXL	188	82-028	208	82-128	208	82-324	211	82-750-45	210		
81-628	206	81-732-XXXL	201	81-777-L	188	82-030	207	82-131	209	82-350	211	82-750-46	210		
81-630	205	81-733-L	201	81-777-M	188	82-031	207	82-132	209	82-351	211	82-750-47	210		
81-631	205	81-733-M	201	81-777-S	188	82-032	207	82-133	209	82-355	211	82-760-36	209		
81-632	205	81-733-S	201	81-777-XL	188	82-033	207	82-134	209	82-356	211	82-760-37	209		
81-660-L/XL	204	81-733-XXL	201	81-777-XXL	188	82-034	207	82-135	209	82-360	211	82-760-38	209		
81-660-S/M	204	81-733-XXXL	201	81-778-L	189	82-035	207	82-136	209	82-361	211	82-760-39	209		
81-660-XXL/XXXL	204	81-740-L	195	81-778-M	189	82-036	207	82-137	209	82-365	211	82-760-40	209		
81-661-L/XL	204	81-740-M	195	81-778-S	189	82-037	207	82-140	209	82-366	211	82-760-41	209		
81-661-S/M	204	81-740-S	195	81-778-XL	189	82-038	207	82-141	209	82-510-36	206	82-760-42	209		
81-661-XXL/XXXL	204	81-740-XL	195	81-778-XXL	189	82-040	208	82-142	209	82-510-37	206	82-760-43	209		
81-662-L/XL	204	81-740-XXL	195	81-779-L	187	82-041	208	82-143	209	82-510-38	206	82-760-44	209		
81-662-S/M	204	81-741-L	195	81-779-M	187	82-042	208	82-144	209	82-510-39	206	82-760-45	209		
81-662-XXL/XXXL	204	81-741-M	195	81-779-S	187	82-043	208	82-145	209	82-510-40	206	82-760-46	209		
81-663-L/XL	204	81-741-S	195	81-779-XL	187	82-044	208	82-146	209	82-510-41	206	82-760-47	209		
81-663-S/M	204	81-741-XXL	195	81-779-XXL	187	82-045	208	82-147	209	82-530-36	206	82-770-36	210		
81-663-XXL/XXXL	204	81-741-XXL	195	81-780-L	190	82-046	208	82-148	209	82-530-37	206	82-770-37	210		
81-670-L/XL	204	81-742-L	194	81-780-M	190	82-047	208	82-150-39	206	82-530-38	206	82-770-38	210		
81-670-S/M	204	81-742-M	194	81-780-S	190	82-048	208	82-150-40	206	82-530-39	206	82-770-39	210		
81-670-XXL/XXXL	204	81-742-S	194	81-780-XL	190	82-070-36	209	82-150-41	206	82-530-40	206	82-770-40	210		
81-671-L/XL	204	81-742-XL	194	81-780-XXL	190	82-070-37	209	82-150-42	206	82-530-41	206	82-770-41	210		
81-671-S/M	204	81-742-XXL	194	81-781-L	190	82-070-38	209	82-150-43	206	82-540-36	206	82-770-42	210		
81-671-XXL/XXXL	204	81-742-XXXL	194	81-781-M	190	82-070-39	209	82-150-44	206	82-540-37	206	82-770-43	210		
81-672-L/XL	204	81-745-L	195	81-781-S	190	82-070-40	209	82-150-45	206	82-540-38	206	82-770-44	210		
81-672-S/M	204	81-745-M	195	81-781-XL	190	82-070-41	209	82-150-46	206	82-540-39	206	82-770-45	210		
81-672-XXL/XXXL	204	81-745-S	195	81-781-XXL	190	82-070-42	209	82-150-47	206	82-540-40	206	82-770-46	210		
81-673-L/XL	204	81-745-XL	195	81-782-L	190	82-070-43	209	82-151-39	208	82-540-41	206	82-770-47	210		
81-673-S/M	204	81-745-XXL	195	81-782-M	190	82-070-44	209	82-151-40	208	82-700	210	82S101	213		
81-673-XXL/XXXL	204	81-746-L	195	81-782-S	190	82-070-45	209	82-151-41	208	82-701	210	82S102	213		
81-700-L	195	81-746-M	195	81-782-XL	190	82-070-46	209	82-151-42	208	82-702	210	82S131	212		
81-700-M	195	81-746-S	195	81-782-XXL	190	82-070-47	209	82-151-43	208	82-703	210	82S132	212		
81-700-S	195	81-746-XL	195	81-783-L	191	82-080-36	209	82-151-44	208	82-704	210	82S133	212		

Ref.	Str.	Ref.	Str.	Ref.	Str.	Ref.	Str.	Ref.	Str.	Ref.	Str.
82S137	212	84-256	287	90-090	354	97-360	211	97-657-8	217	99-046	335
82S138	212	84-257	287	90-091	354	97-361	211	97-657-9	217	99-047	338
82S160	215	84-259	286	90-092	354	97-362	211	97-657-10	217	99-048	338
82S161	215	84-266	287	90-093	354	97-500	213	97H120	379	99-049	338
82S162	215	84-267	287	90-094	354	97-501	213	97H121	379	99-050	338
82S170	218	84-268	287	90-095	354	97-502	213	97H122	379	99-051	339
82S200	215	84-269	287	90-096	354	97-503	213	97H136	379	99-052	339
82S201	215	84-276	287	90-097	354	97-504	213	97H137	379	99-053	339
82S210	218	84-277	287	90-098	354	97-508	213	97H138	379	99-054	339
82S211	218	84-278	287	90-099	354	97-510	213	97H140	379	99-055	340
82S220	215	84-286	287	90-100	354	97-511	213	97H141	379	99-057	340
82S221	215	84-287	287	90-101	354	97-512	213	97H142	379	99-058	340
83S201	218	84-300	292	90-102	354	97-513	213	97H151	379	99-059	339
83S202	218	84-301	292	90-103	354	97-530	215	97H152	379	99-060	339
83S203	218	84-302	294	90-104	354	97-535	214	97H153	379	99-061	339
83S213	218	84-303	292	90-105	354	97-536	214	97H300	379	99-062	339
84-060	288	84-304	292	90-106	354	97-537	214	97X032	162	99-063	339
84-061	288	84-305	292	90-107	354	97-538	214	97X033	162	99-101	334
84-062	288	84-306	294	90-108	354	97-550	214	97X035	162	99-200	336
84-063	288	84-308	292	90-108-1	354	97-555	214	97X040	162	99-201	336
84-064	288	84-311	294	90-109	354	97-560	214	97X042	162	100.0	258
84-065	288	84-315	293	90-121	355	97-561	214	97X043	162	320.0	258
84-066	288	84-321	347	90-122	355	97-562	214	97X071	162	K112945	355
84-092	285	84-322	347	90-125	355	97-563	214	97X072	162	K112945	355
84-093	285	84-323	348	90-127	355	97-590	215	97X080	163	K112946	355
84-094	286	84-324	348	90-130	356	97-602	217	97X082	163	K112946	355
84-095	285	84-325	348	90-131	356	97-603	217	97X085	163	K112947	355
84-096	285	84-326	348	90-132	356	97-604	217	97X087	163	K112947	355
84-097	285	84-330	295	90U108	381	97-605	217	97X183	301	K112948	355
84-098	286	84-332	295	90U109	381	97-606	217	97X184	301	K112948	355
84-100	289	84-333	296	90U212	381	97-609-8	216	97X185	301	K112950	355
84-101	289	84-334	296	90U214	381	97-609-9	216	97X186	301	K112950	355
84-102	289	84-335	295	90U245	382	97-609-10	216	97X192	301	K112950	355
84-105	289	84-350	287	90U250	382	97-610-8	216	97X195	301	K112951	355
84-114	289	84-400	299	90U256	382	97-610-9	216	97X198	301	K112951	355
84-115	289	84-401	299	90U263	381	97-610-10	216	97X199	301		
84-116	289	84-402	299	90U270	381	97-611	217	97X206	301		
84-117	289	84-403	299	90U271	381	97-615	217	97X250	159		
84-118	291	84-500	297	90U272	381	97-616-8	216	97X269	164		
84-119	291	84-501	297	90U273	381	97-616-9	216	97X272	147		
84-130	291	84-502	297	90U280	381	97-616-10	216	97X300	143		
84-131	291	84-503	297	90U281	381	97-617-8	216	97X501	160		
84-140	301	90-001	350	90U300	381	97-617-9	216	98Z007	321		
84-141	300	90-002	350	90U301	381	97-617-10	216	98Z017	321		
84-142	299	90-003	350	90U302	381	97-620-8	216	98Z027	322		
84-143	299	90-004	350	90U303	381	97-620-9	216	98Z028	322		
84-144	297	90-005	350	90U304	381	97-620-10	216	98Z053	322		
84-219	282	90-006	350	90U330	381	97-621-8	216	98Z058	322		
84-220	279	90-007	350	90U332	381	97-621-9	216	98Z101	321		
84-221	278	90-008	350	90U333	381	97-621-10	216	98Z102	321		
84-221+G	278	90-030	351	90U460	381	97-630-8	216	98Z103	321		
84-222	278	90-031	351	94-001	276	97-630-9	216	98Z105	321		
84-222+G	278	90-032	351	94-002	276	97-630-10	216	98Z106	321		
84-223	279	90-033	352	94-003	276	97-631-8	216	98Z107	321		
84-223+G	279	90-034	351	94W104	276	97-631-9	216	98Z110	321		
84-226	286	90-035	351	94W105	276	97-631-10	216	98Z116	322		
84-227	286	90-036	352	94W120	259	97-640-8	216	98Z146	356		
84-228	286	90-037	351	94W213	338	97-640-9	216	98Z147	356		
84-229	279	90-038	351	94W245	338	97-640-10	216	99-026	335		
84-230	279	90-039	351	94W380	335	97-641-8	216	99-027	335		
84-231	280	90-060	352	94W383	338	97-641-9	216	99-028	335		
84-232	280	90-061	352	94W390	336	97-641-10	216	99-029	335		
84-233	282	90-062	352	94W391	336	97-642-8	216	99-030	336		
84-234	282	90-063	352	94W601	340	97-642-9	216	99-031	336		
84-235	282	90-064	352	95-007	375	97-642-10	216	99-032	335		
84-236	281	90-065	352	95-008	375	97-643-8	216	99-033	334		
84-237	281	90-066	352	95-011	376	97-643-9	216	99-034	334		
84-238	281	90-067	352	97-300	212	97-643-10	216	99-035	334		
84-239	281	90-068	352	97-301	212	97-650	217	99-036	334		
84-240	280	90-069	352	97-311	212	97-651	217	99-037	334		
84-241	281	90-070	353	97-321	212	97-652	217	99-038	337		
84-242	280	90-071	353	97-336	212	97-653	218	99-039	337		
84-243	281	90-080	353	97-336-20	212	97-655-8	217	99-040	337		
84-244	280	90-081	353	97-337	212	97-655-9	217	99-041	337		
84-246	282	90-082	353	97-337-20	212	97-655-10	217	99-042	337		
84-247	280	90-083	353	97-338	212	97-656-8	217	99-043	337		
84-249	282	90-084	353	97-338-20	212	97-656-9	217	99-044	337		
84-255	287	90-085	353	97-350	211	97-656-10	217	99-045	335		



Grupa Topex Sp. z o.o. Sp.k.
ul. Pograniczna 2/4,
02-285 Warszawa
tel. +48 22 573 03 00
fax +48 22 573 04 00
office@grupatopex.com



Россия

ООО «ТОПЕКС РУС»
108811 Россия, г. Москва,
г. Московский;
1 микрорайон; дом 23 «Д»;
3 этаж; офис 2,3
Тел. +7 499 346 37 27
office@topex.net.ru



Україна

ТОВ «Топекс Україна»
07400, м. Бровари,
вул. О.Онiкiєнка, буд. 134,
тел +38044-495-45-04
office@topex.ua



Romania

Topex Tools Romania SRL
tel: 0040 37 2740 619
fax: 0040 37 2870 177
romania@grupatopex.com

Grupa Topex nie ponosi żadnej odpowiedzialności za możliwe błędy w katalogach, broszurach i innych materiałach drukowanych. Grupa Topex zastrzega sobie prawo do dokonywania zmian w produktach bez uprzedzenia. Dotyczy to również produktów już zamówionych. Zamienniki mogą być dostarczone bez dokonywania jakichkolwiek zmian w specyfikacjach już uzgodnionych. Wszystkie znaki towarowe w tym materiale są własnością odpowiednich firm. Znaki towarowe GRAPHITE, VERTO, NEO, Top Tools są własnością "Grupa Topex Sp. z o.o." Sp.k. Niniejszy katalog ma jedynie charakter informacyjny i nie stanowi oferty zawarcia umowy. Zdjęcia umieszczone w katalogu są zdjęciami poglądowymi i produkty w rzeczywistości mogą się nieznacznie różnić od zamieszczonych ilustracji. Publikacja chroniona prawem autorskim. Kopiowanie, przedrukowywanie i rozpowszechnianie całości lub fragmentów, również na nośnikach magnetycznych lub elektronicznych bez zgody firmy Grupa Topex jest zabronione.

Grupa Topex shall not be held liable for any errors in catalogues, brochures and other printed materials. Grupa Topex stipulates the right to modify the products without prior notice. This shall also apply to products already ordered. Replacements may be delivered without any modifications of specifications already agreed upon. All trademarks, inclusive of those contained in this material, are the property of relevant companies. GRAPHITE, VERTO, NEO, Top Tools trademarks are the property of "Grupa Topex Sp. z o.o." Sp.k. Limited Partnership. This catalogue is intended for informational purposes only and is not a binding offer for agreement. Pictures in the catalogue are for illustration purposes, real products may slightly vary from provided illustrations. Publication protected under copyright law. Copying, reprinting and distribution of the entirety or parts thereof, inclusive of on magnetic and electronic media, without the consent of Grupa Topex shall be prohibited.

Grupa Topex не несет никакой ответственности за возможные ошибки в каталогах, брошюрах и других печатных материалах. Grupa Topex оставляет за собой право без предупреждения вносить изменения в продукты. Это касается также уже заказанных продуктов. Измененные продукты могут поставляться без внесения каких-либо изменений в уже согласованные спецификации. Все товарные знаки в данном материале являются собственностью соответствующих компаний. Товарные знаки GRAPHITE, VERTO, NEO, Top Tools являются собственностью компании «Grupa Topex Общество с ограниченной ответственностью» Коммандитное товарищество. Данный каталог носит информационный характер, не является офертой и не несет никаких обязательств по заключению договора. Представленные в каталоге фотографии являются наглядными примерами товаров, фактический внешний вид товара может незначительно отличаться от изображенного на фотографии. Публикация защищена законом об авторских правах. Копирование, перепечатка и распространение всего текста полностью или его фрагментов, в том числе на магнитных и электронных носителях, без согласия компании Grupa Topex запрещены.

